

# TRACE LE CHIFFRE

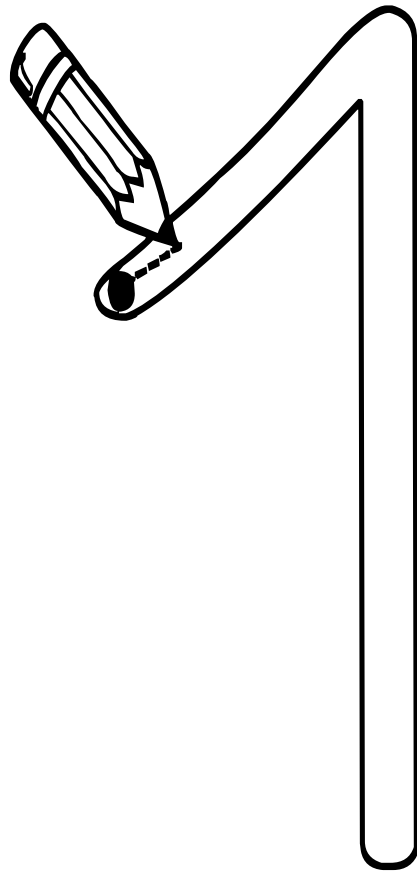

# TRACE LE CHIFFRE

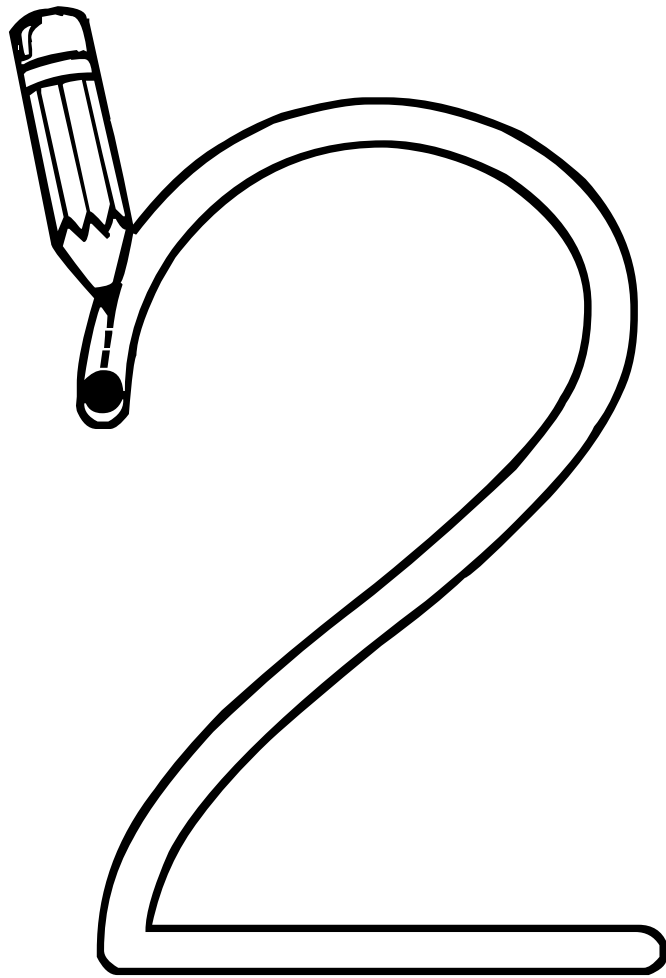

# TRACE LE CHIFFRE

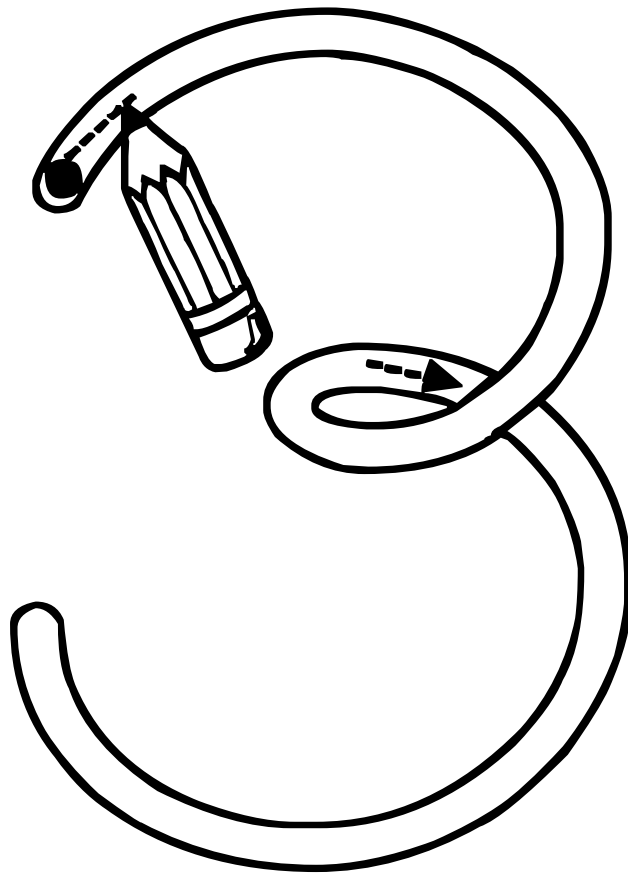

# TRACE LE CHIFFRE

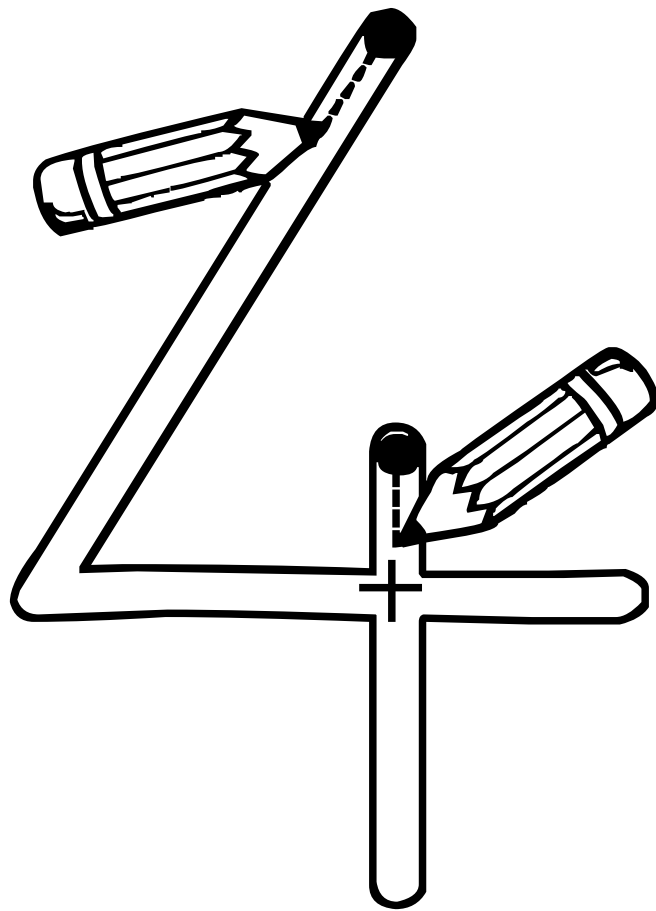

# TRACE LE CHIFFRE

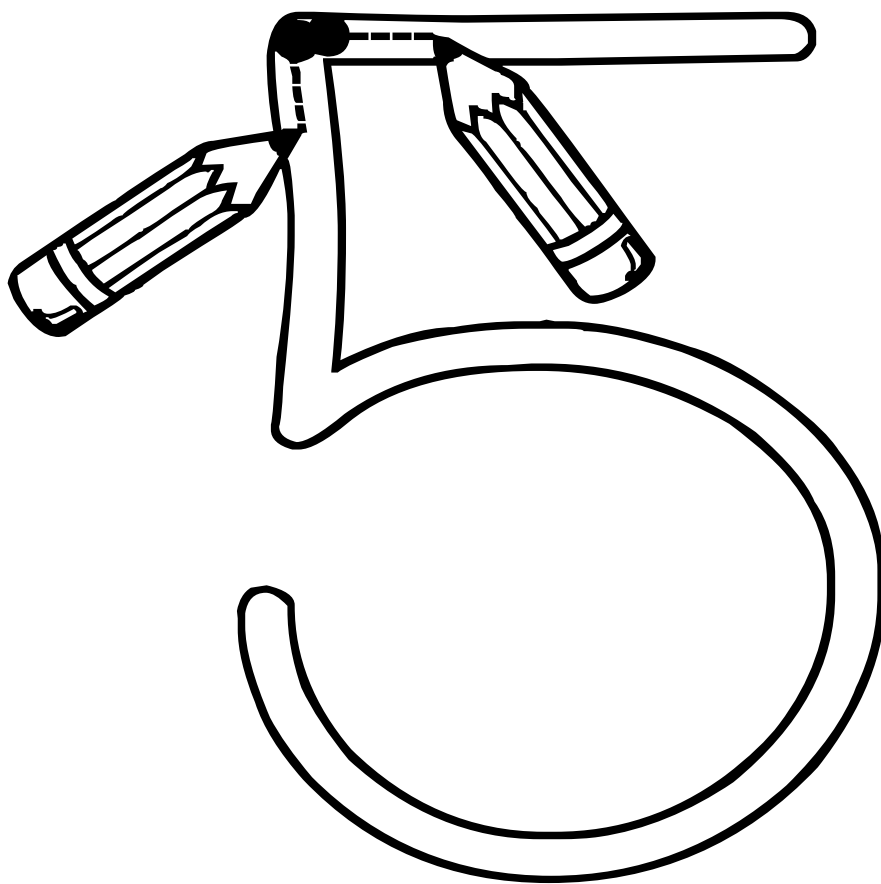

# TRACE LE CHIFFRE

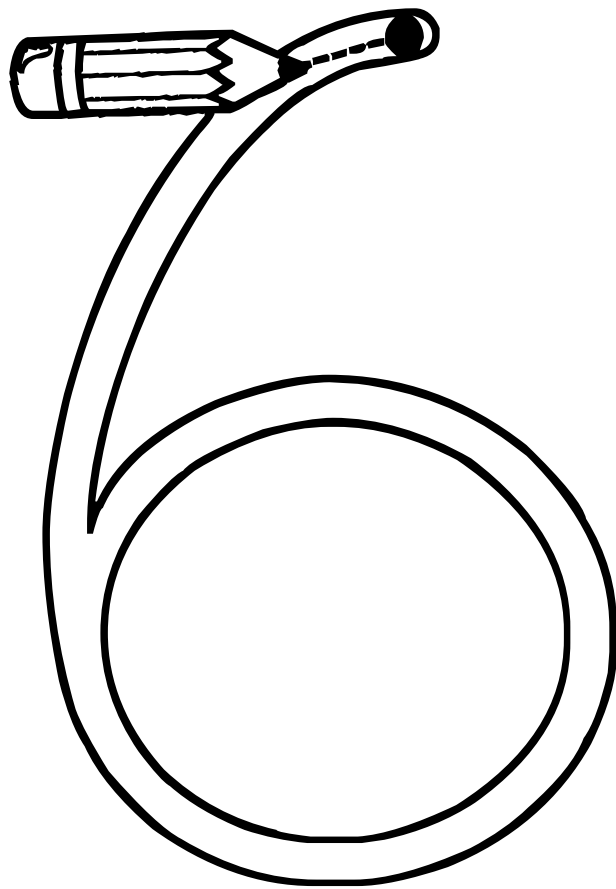

# TRACE LE CHIFFRE

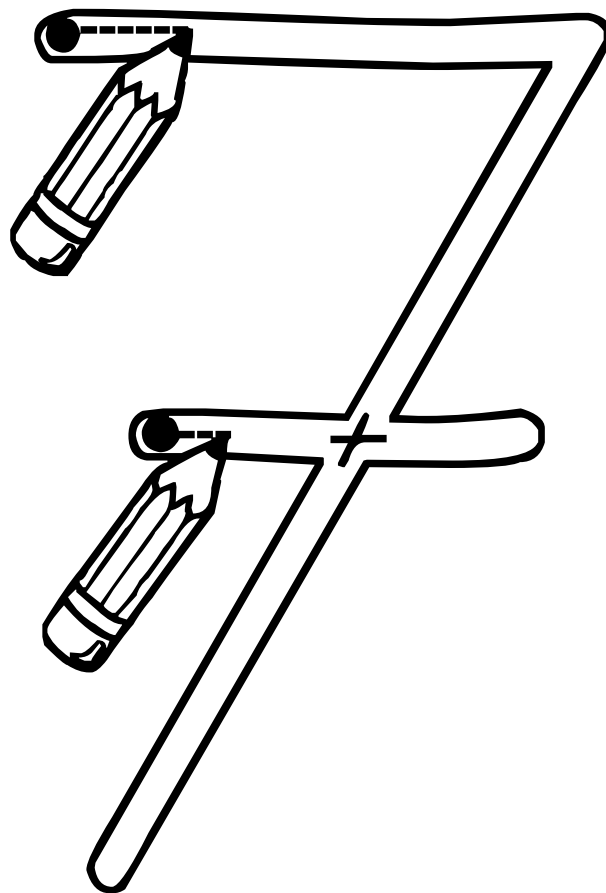

# TRACE LE CHIFFRE

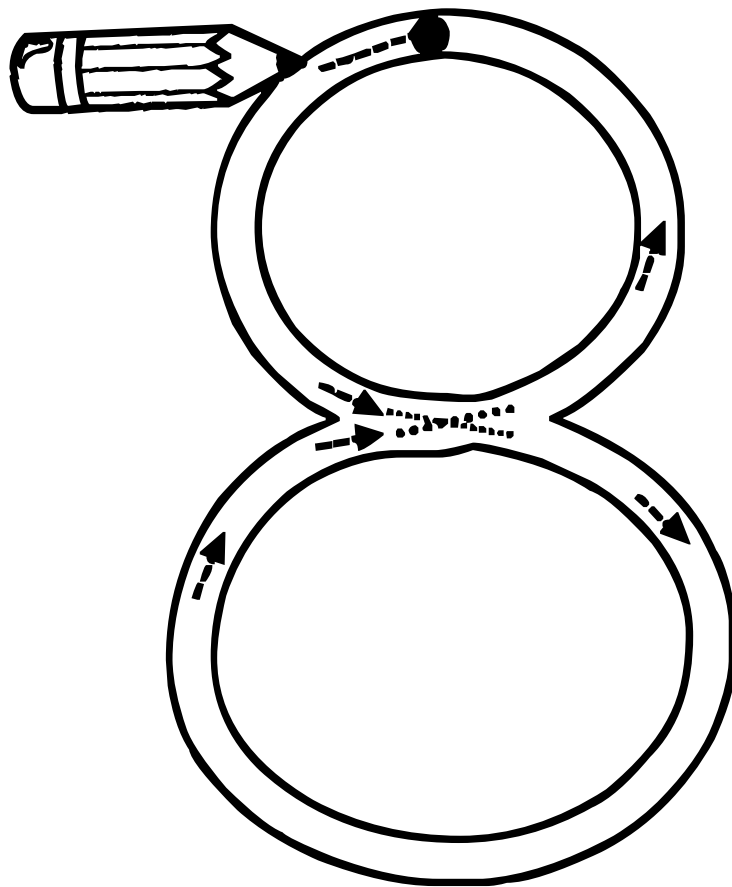



# TRACE LE CHIFFRE

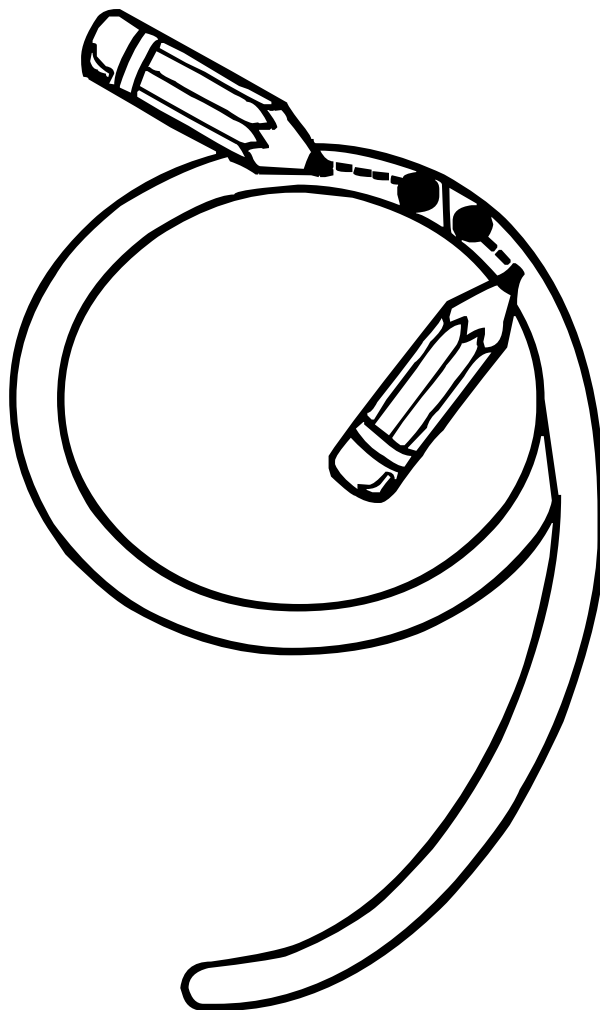

# TRACE LE CHIFFRE

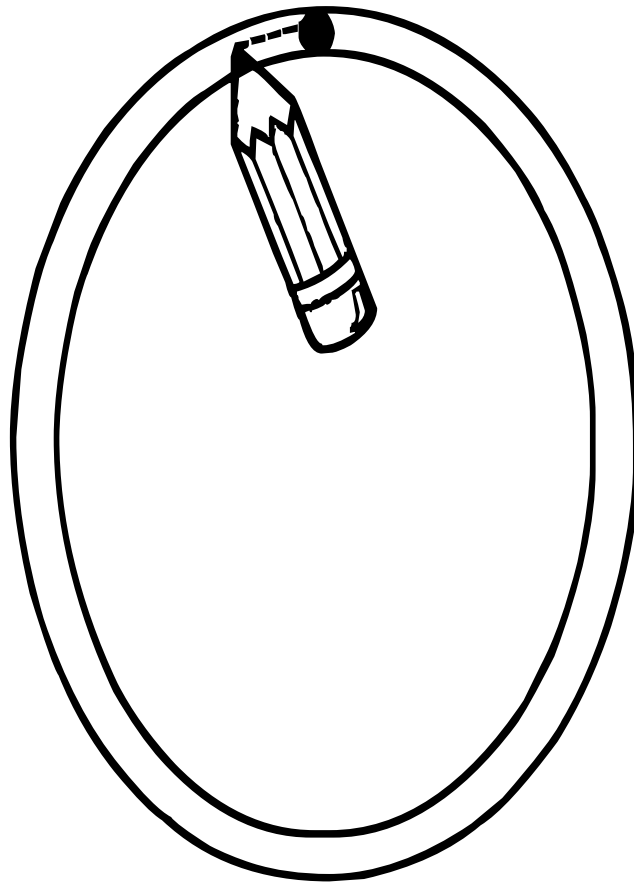

# TRACE LE CHIFFRE

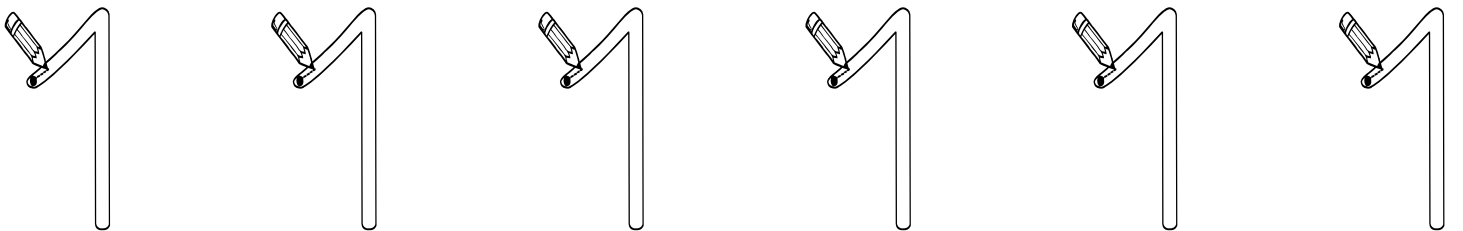
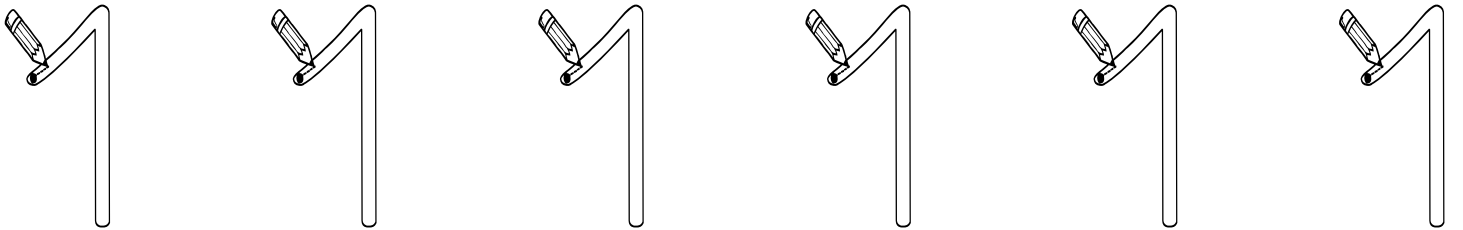
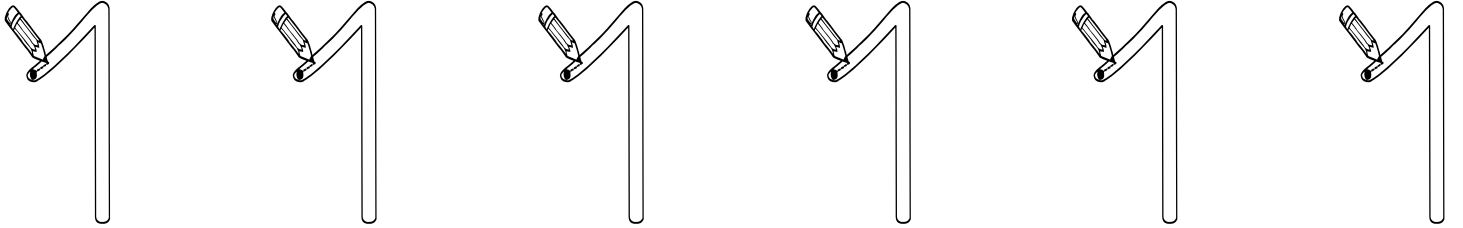

# TRACE LE CHIFFRE

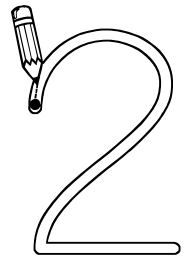
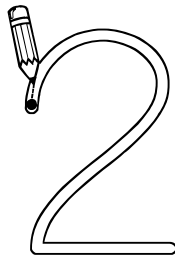
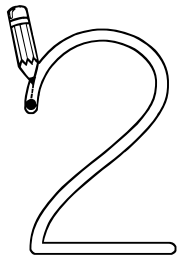
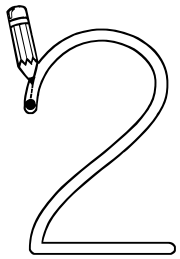
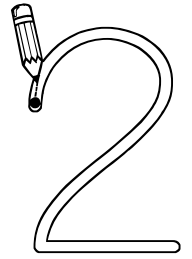
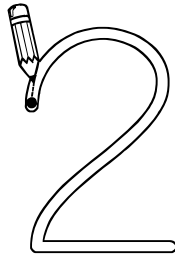
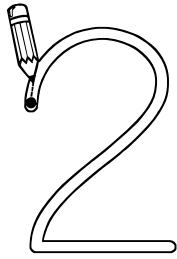
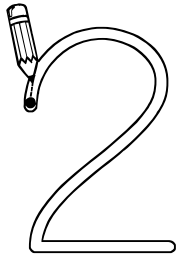
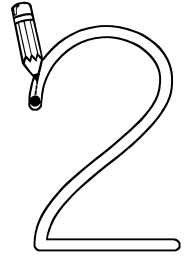
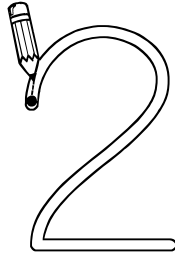
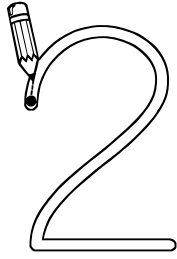
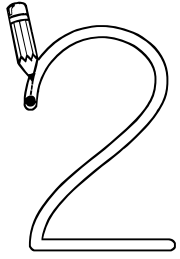





# TRACE LE CHIFFRE

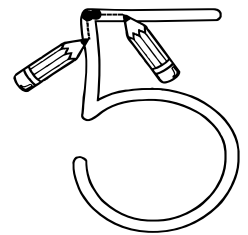
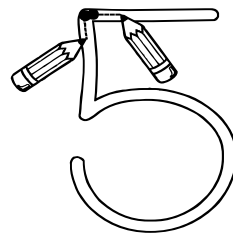
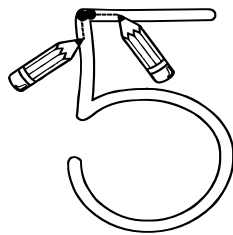
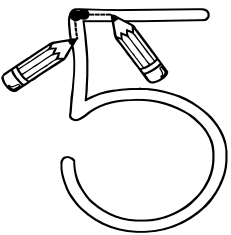
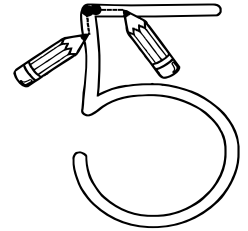
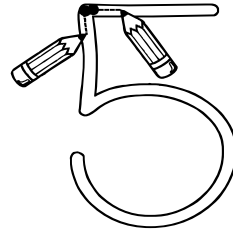
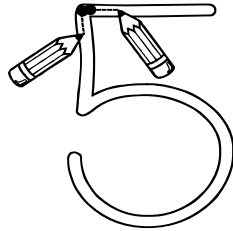
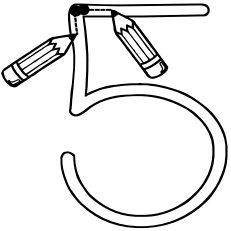
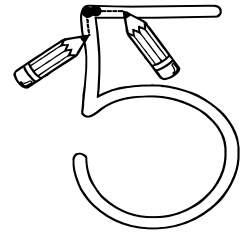
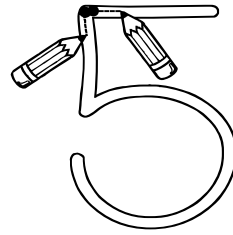
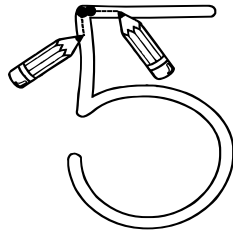
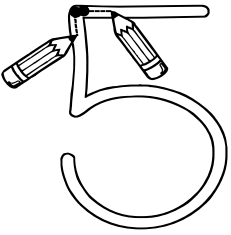

# TRACE LE CHIFFRE

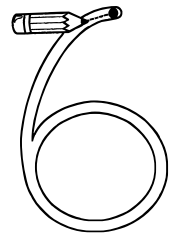
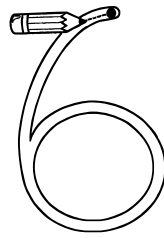
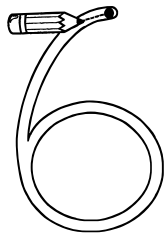
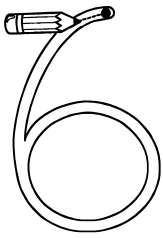
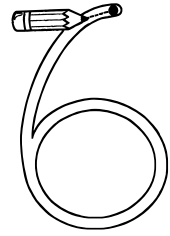
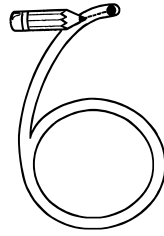
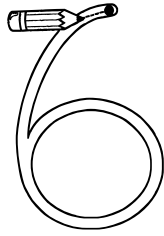
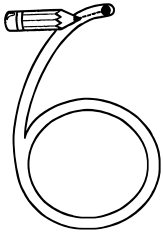
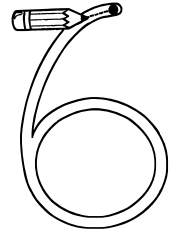
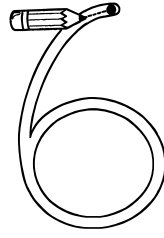
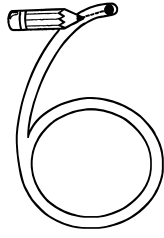
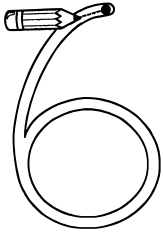



# TRACE LE CHIFFRE

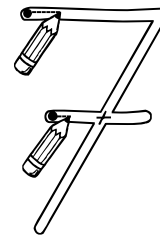
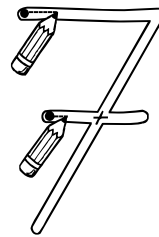
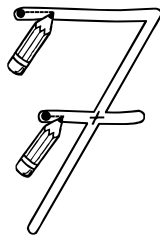
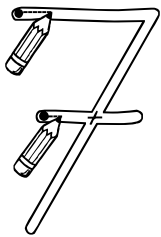
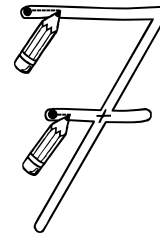
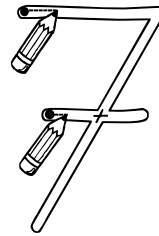
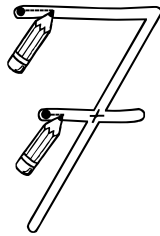
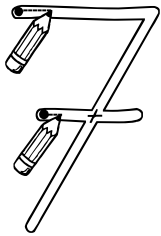
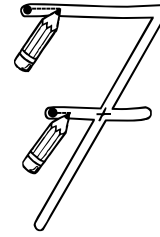
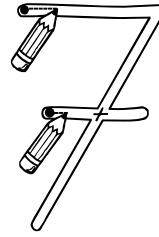
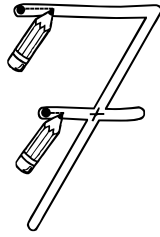
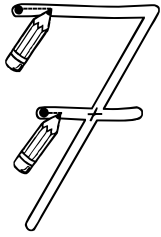





# TRACE LE CHIFFRE

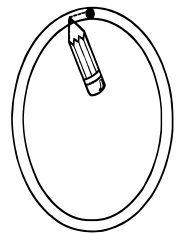
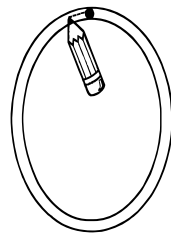
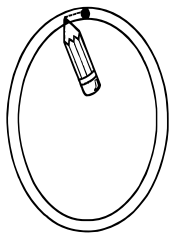
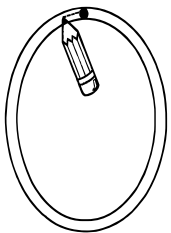
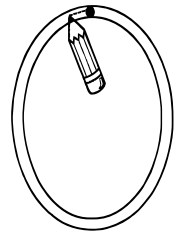
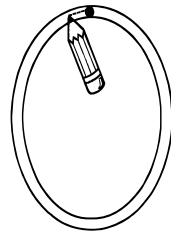
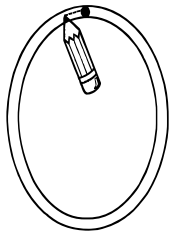
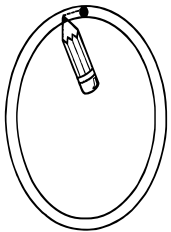
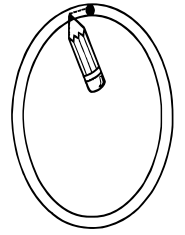
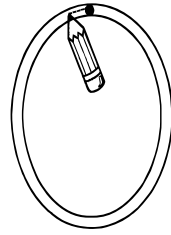
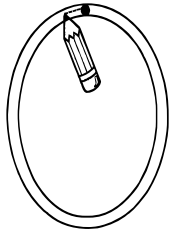
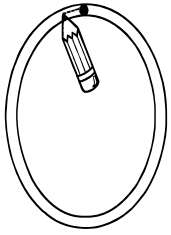

# RAJOUTER À CES FICHES

- ★ Un bac de sable
- ★ Un sac de tracé sensoriel
- ★ Une ardoise avec des feutres
- ★ Les chiffres rugueux
- ★ De la pâte à modeler