

Colorie le plus petit en bleu et le plus grand en vert .

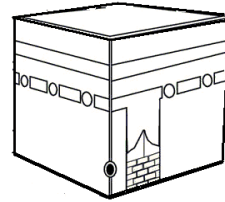

Colorie le plus petit en bleu et le plus grand en vert .

Entoure 7 fois chaque kaaba avec des couleurs différentes (expliquer le tawaf à l'enfant par la même occasion).

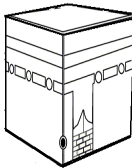
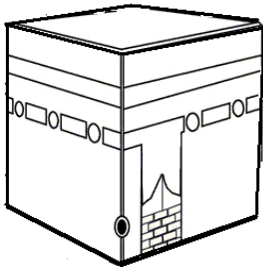
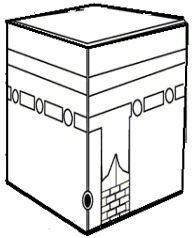
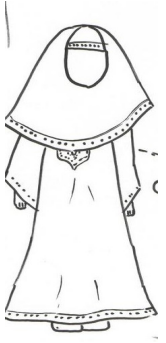
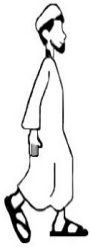
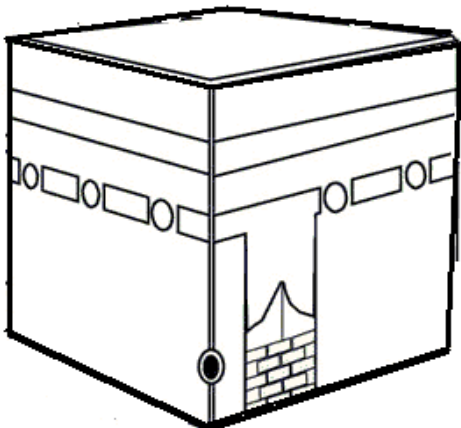
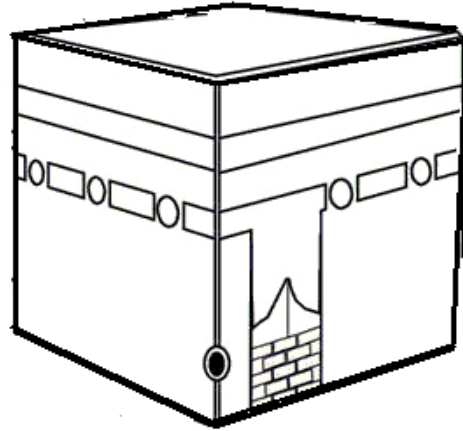
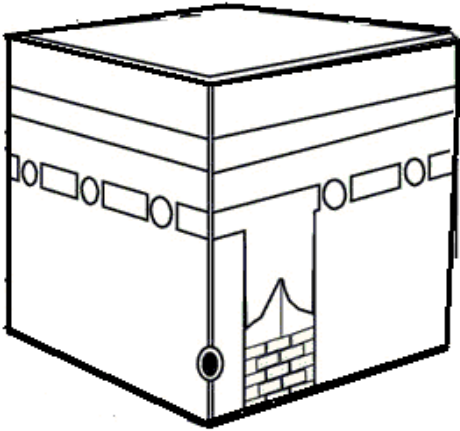

Repasse par dessus les différents chemins et colle des moyens de transport pour chaque chemin.

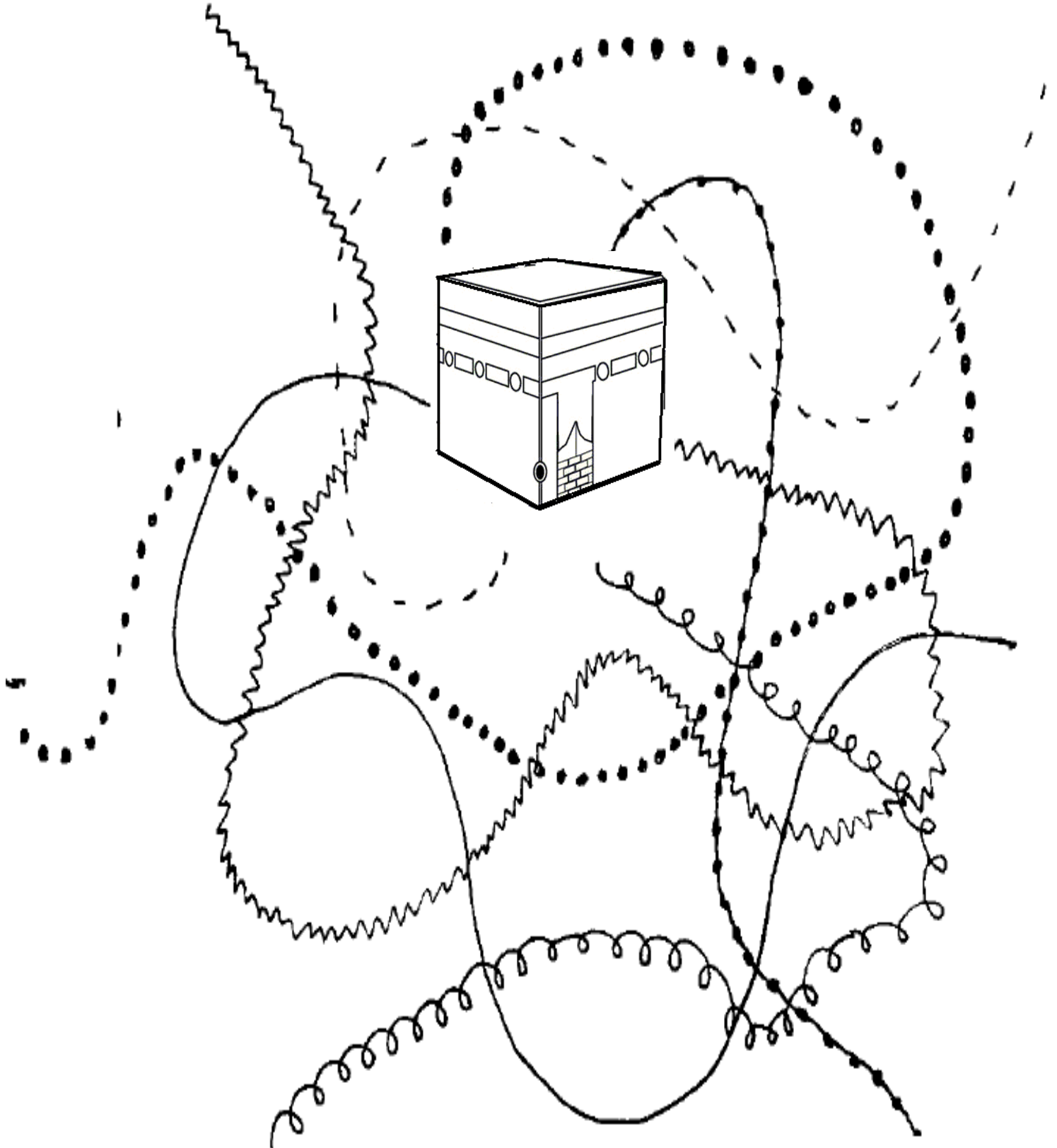

Aide la petite musulman à retrouver la kaaba afin qu'elle effectue son Hajj.

---

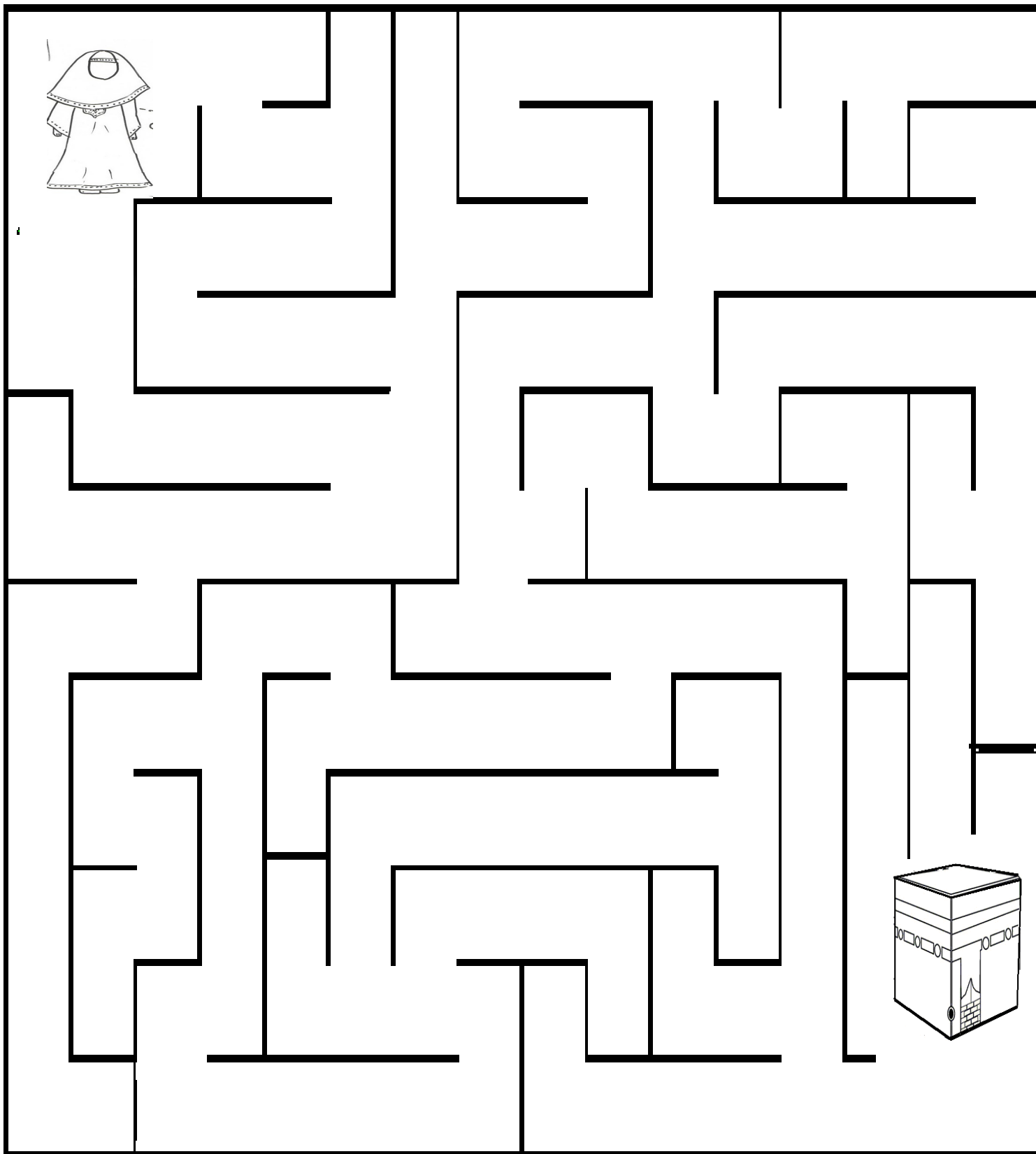

Aide la petite musulman à retrouver la kaaba afin qu'elle effectue son Hajj.

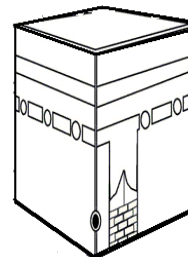
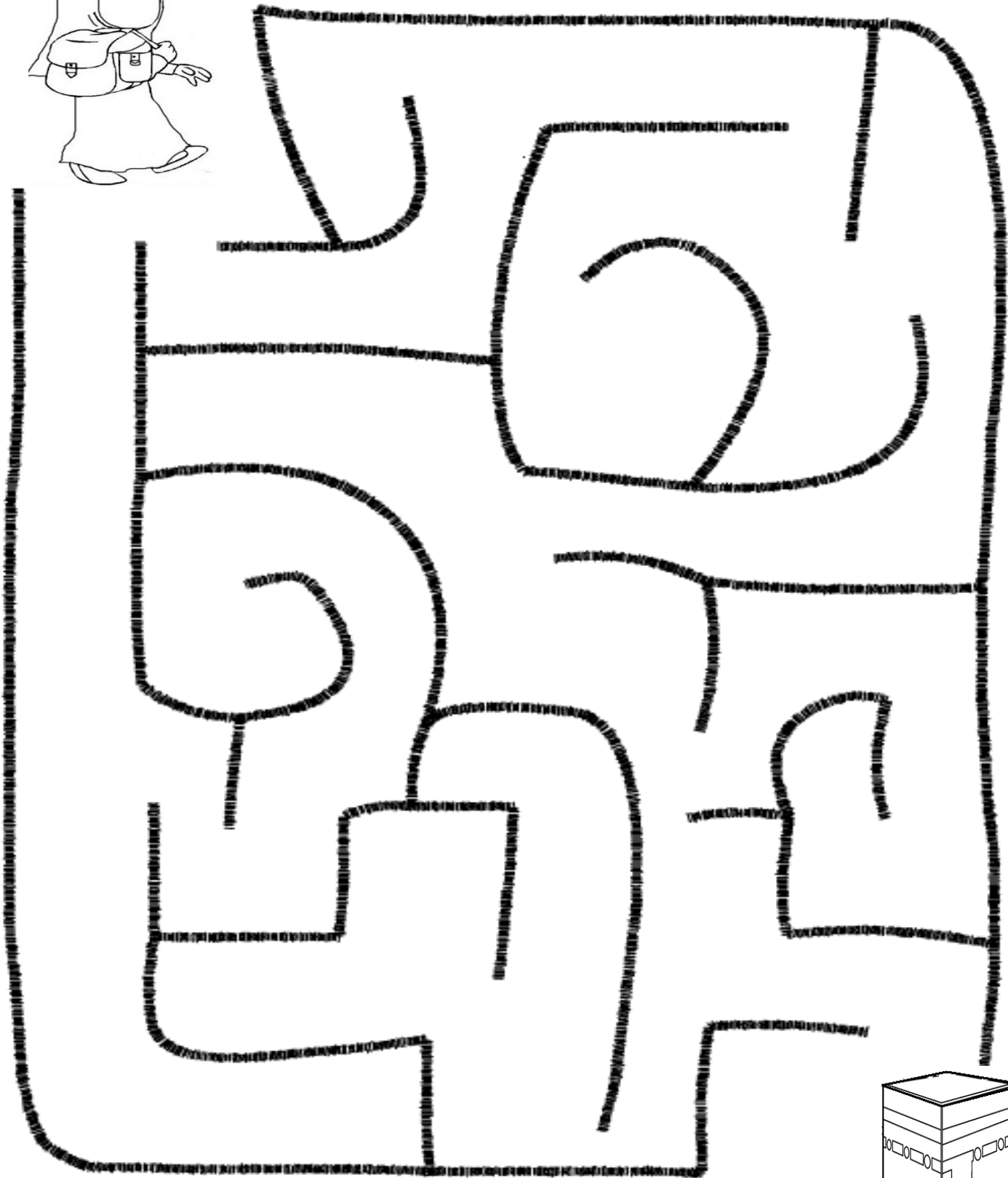

Aide la petite musulmane à retrouver le chemin de la kaaba

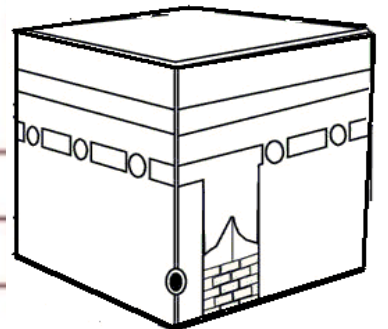
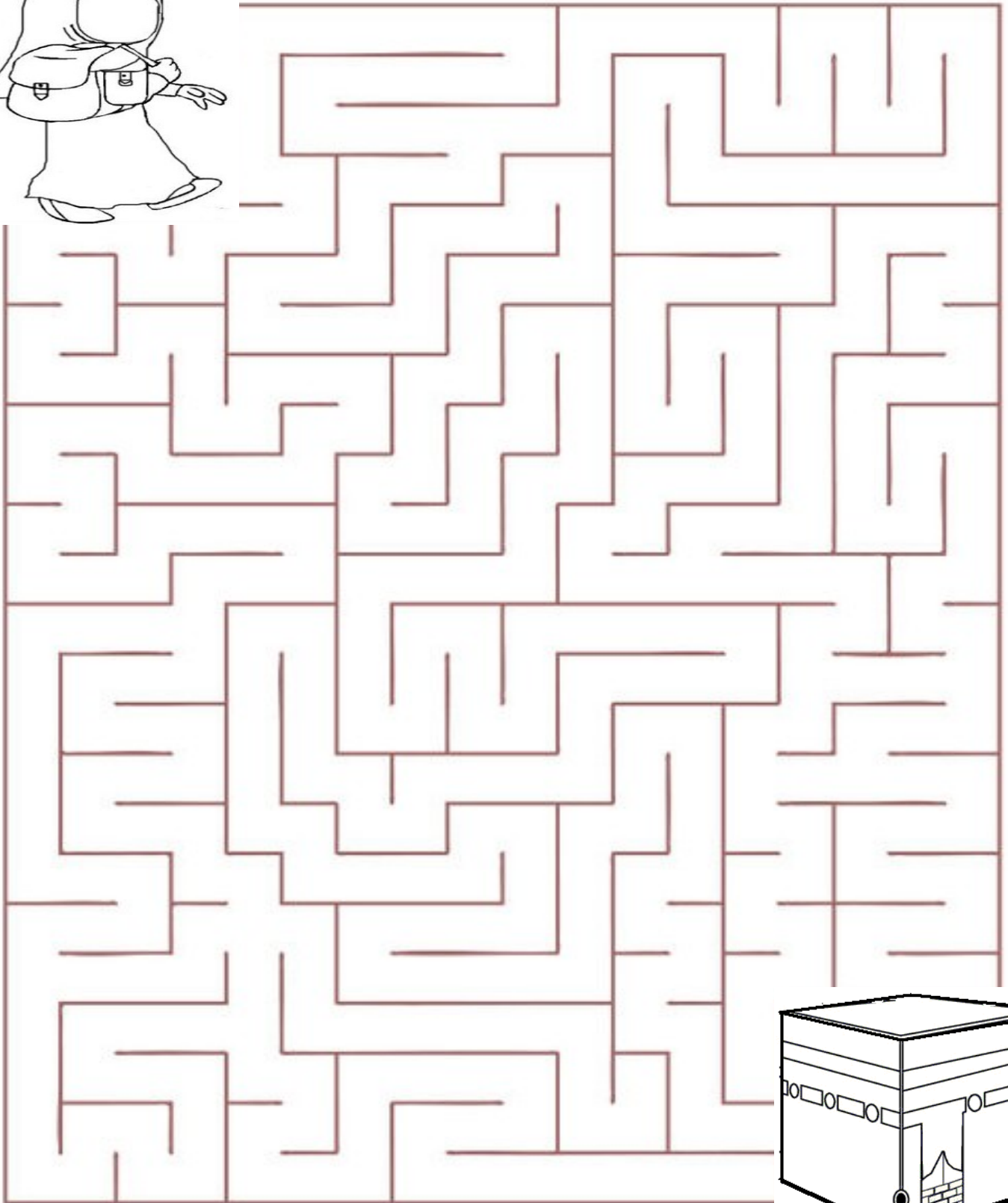

Aide le petit musulman à retrouver la kaaba afin effectue son Hajj.

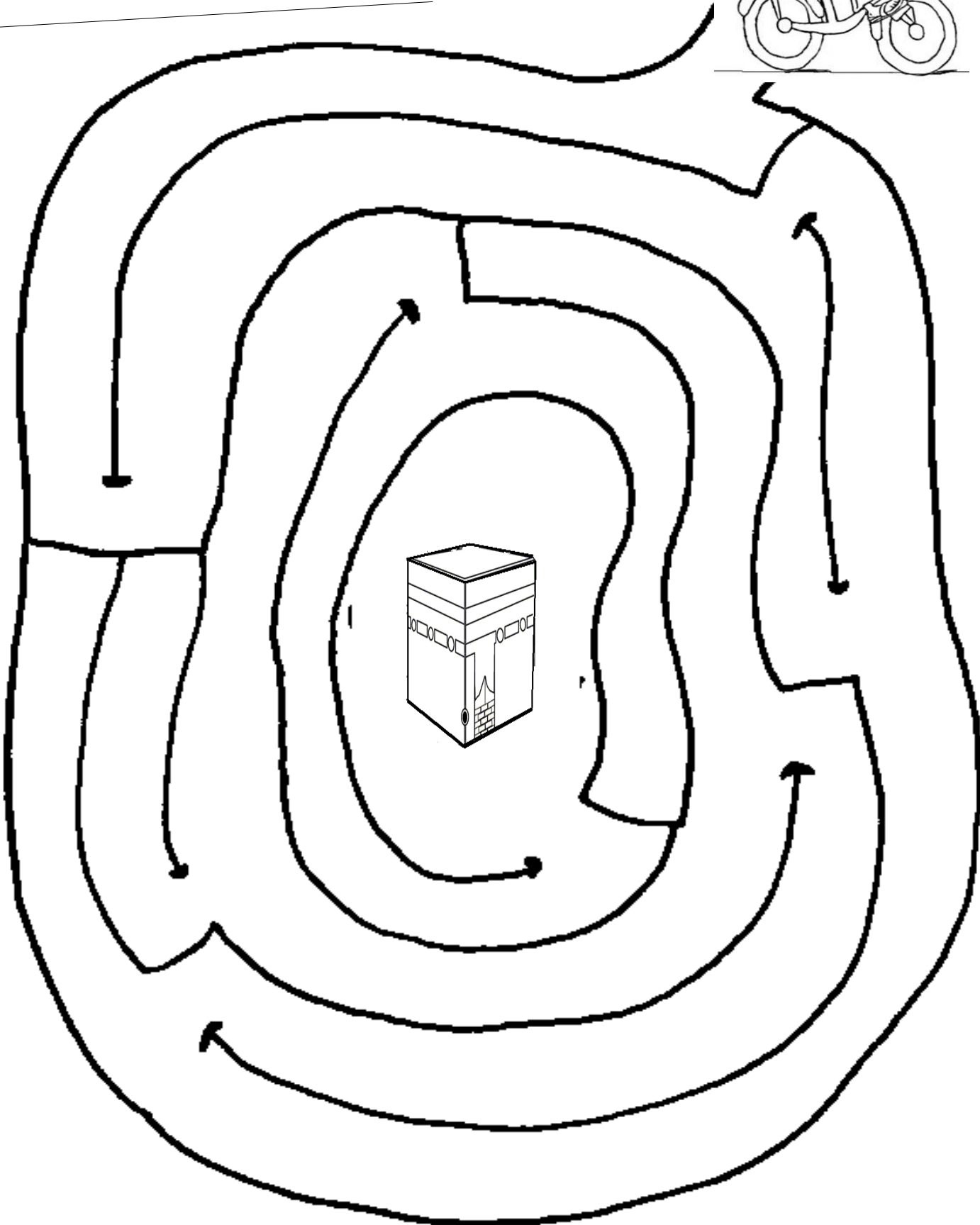



Compte le nombre de kaaba et écris le chiffre dans le carré.

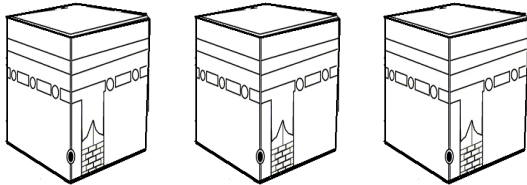

1.

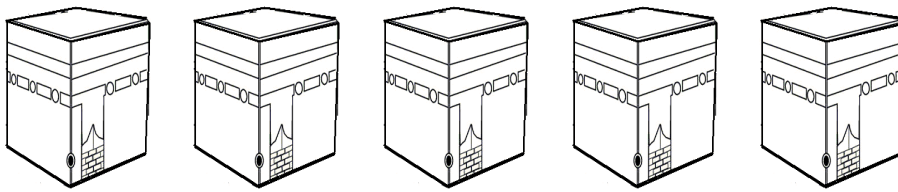

2.

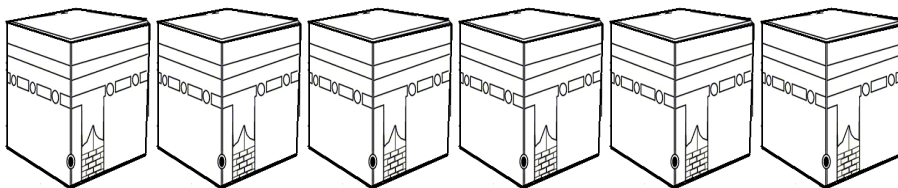

3.

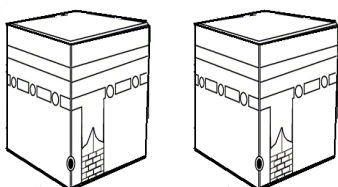

4.

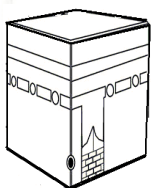

5.

Aide les musulmans à retrouver le chemin de la kaaba en repassant par dessus les chemins

