

Fichier de géométrie et de calcul mental

Prénom : _____

Chaque jour, je réalise l'activité donnée par la
maitresse.

J'essaie d'obtenir le plus d'étoiles possibles.

Trace les traits à la règle comme Géom.

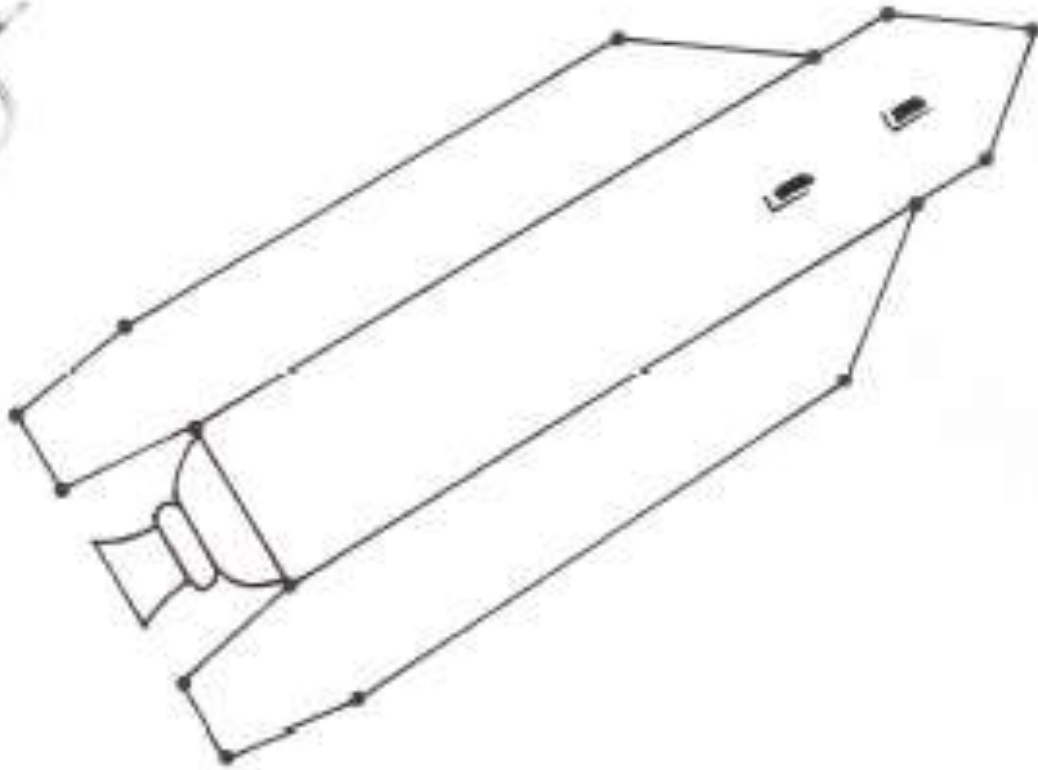

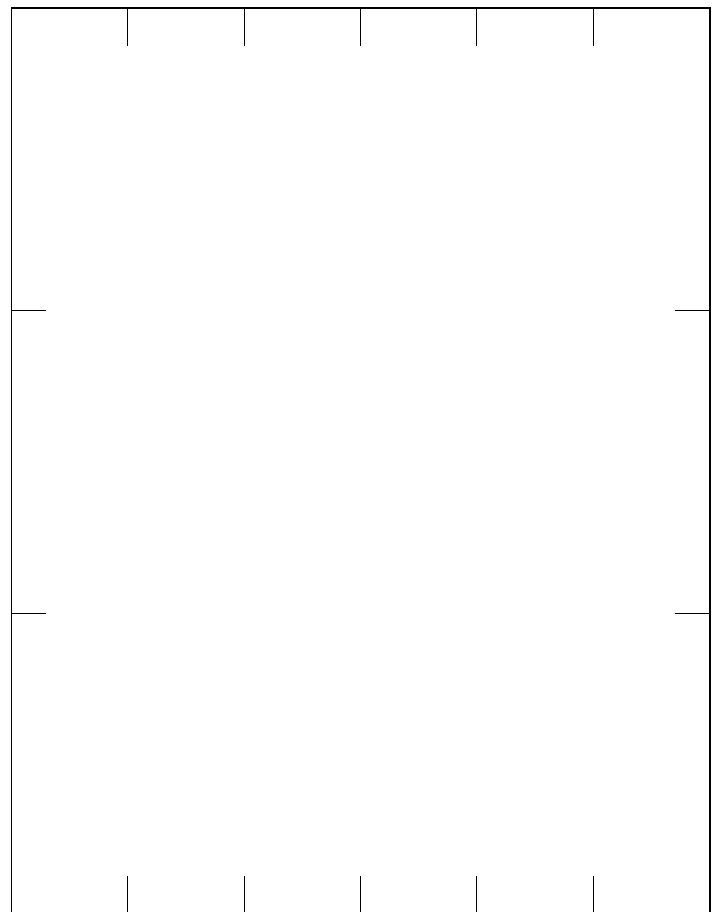
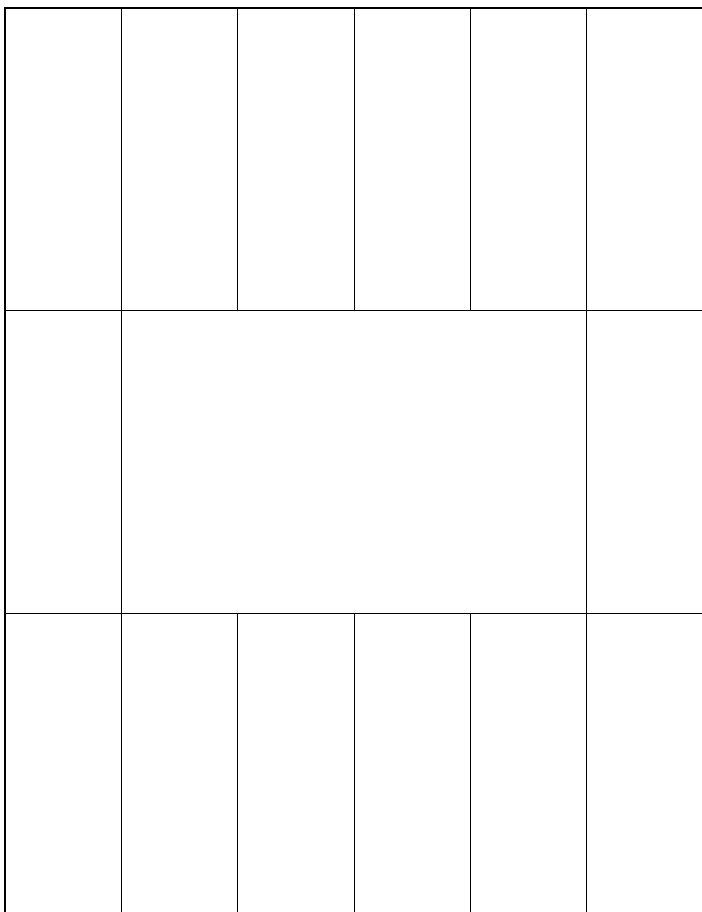
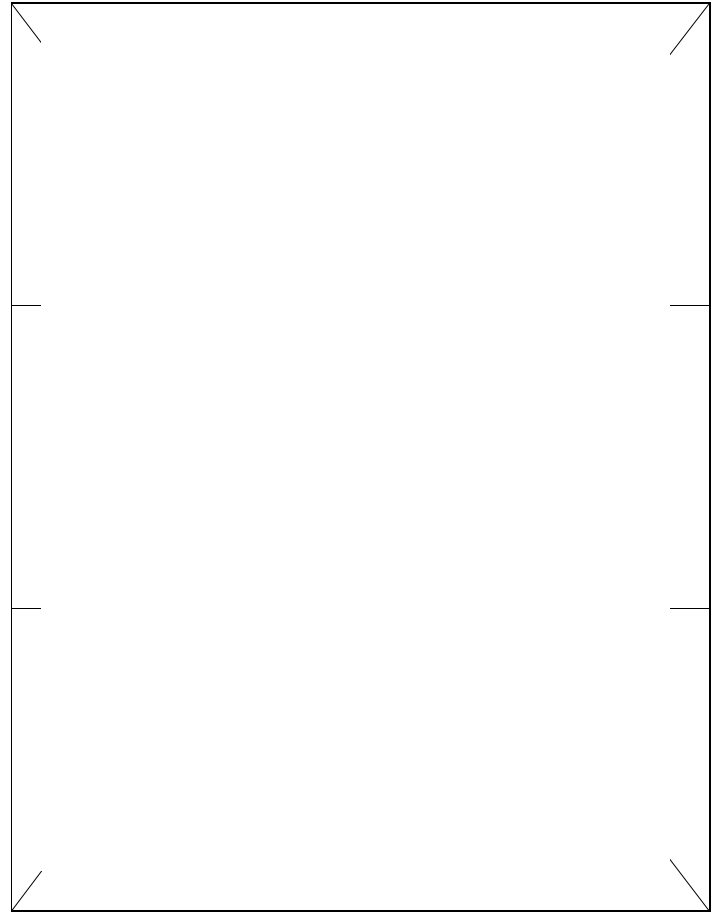
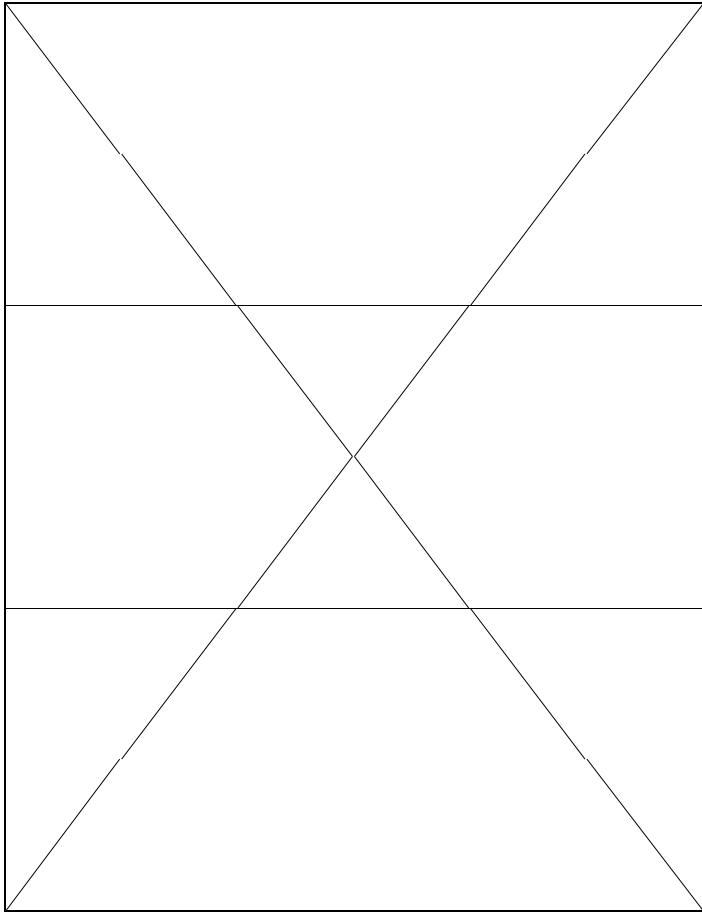

Reproduction sur quadrillage
Géométrie

1

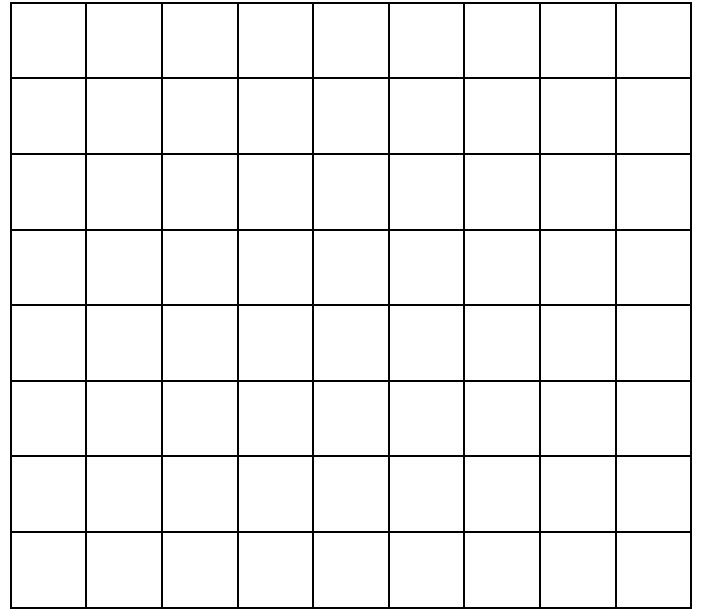
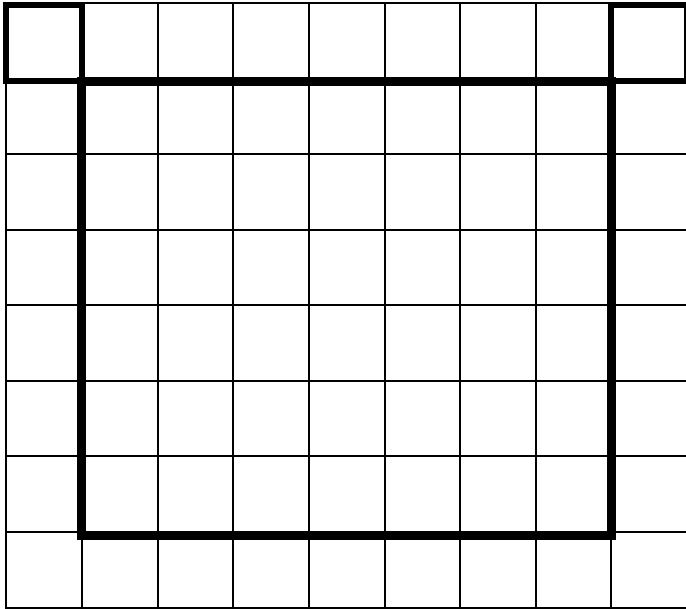

Reproduction sur quadrillage
Géométrie

2

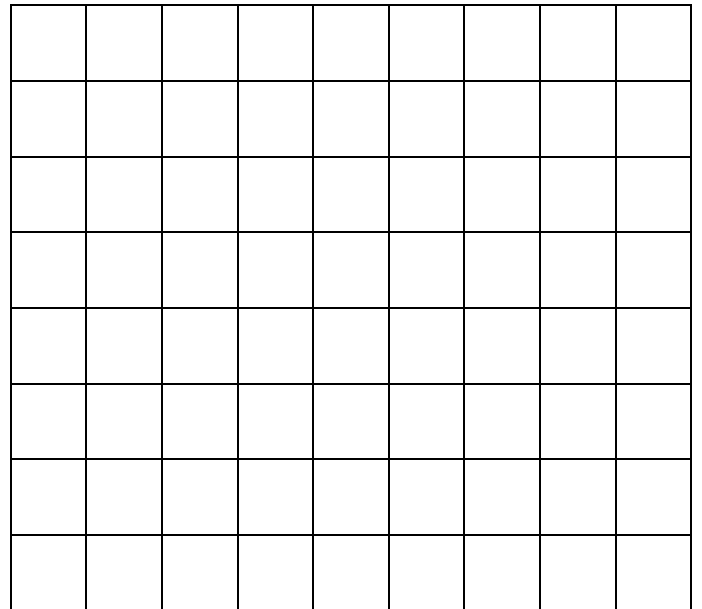
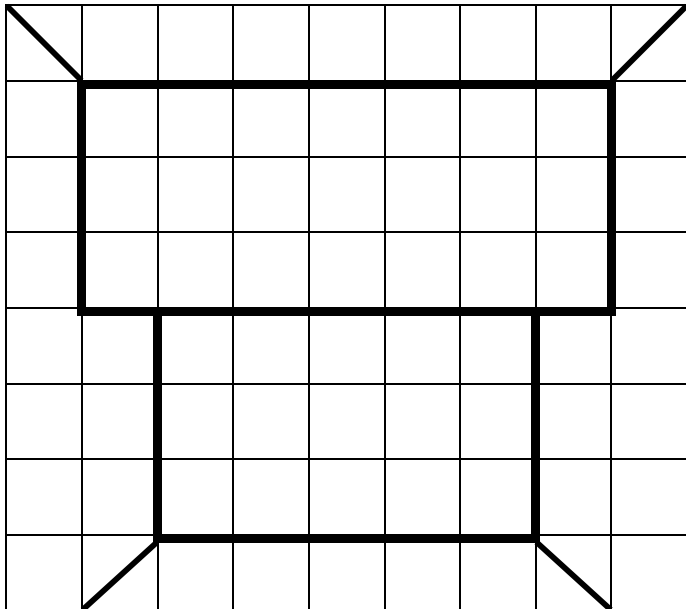

Reproduction sur quadrillage
Géométrie

3

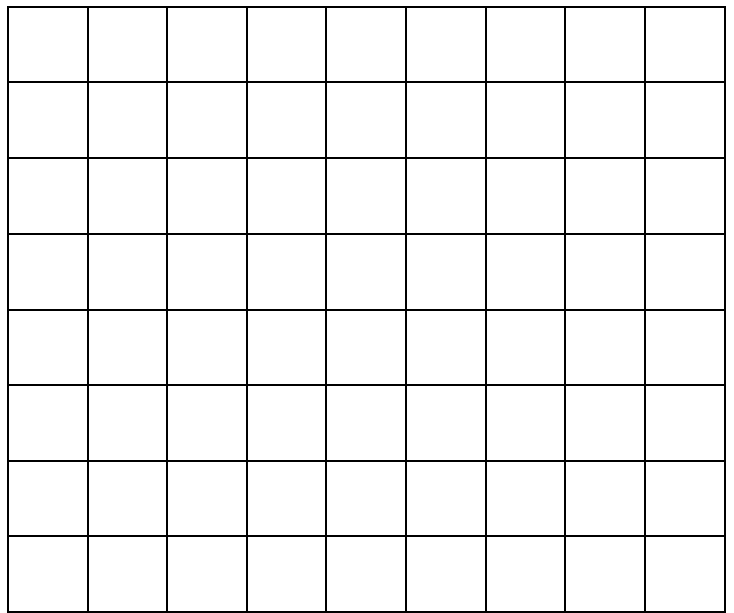
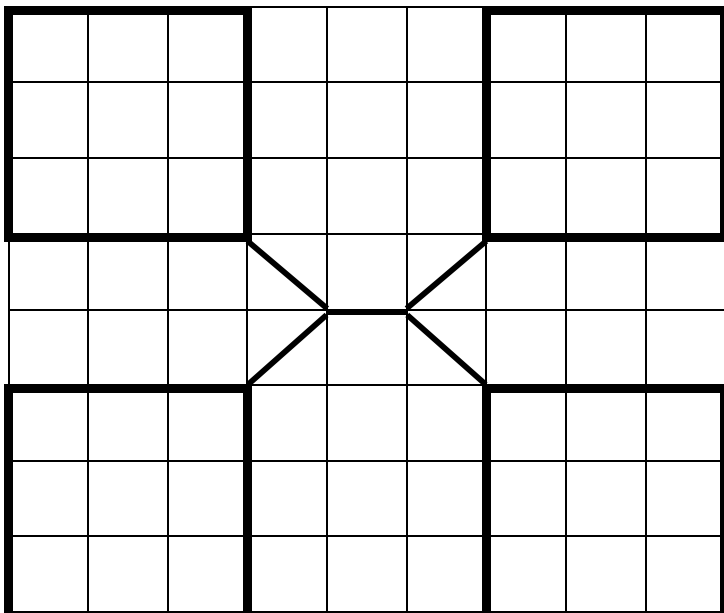

Calcul mental 1



Complète avec les nombres manquants.

1	2		4	5					10
11			14	15	16			19	20
21	22			25	26		28	29	
31			34	35	36	37	38		40
	42	43		45	46		48	49	50
51		53	54		56	57		59	60

Calcul mental 1



1	2			5					
11				15	16	17			20
		23	24	25				29	30
31						37	38	39	
41	42	43					48	49	50
51			54	55	56	57			60

Calcul mental 1



Complète avec les nombres manquants.

	2						8		10
					16	17			20
21	22					27	28		
		33	34	35					40
41			44	45			48	49	
51			54					59	60

Calcul mental 1



1						7			
				15					
		23							30
31			34	35					
				45			48		50
51				55	56	57			



Trace les traits à la règle comme Géom.

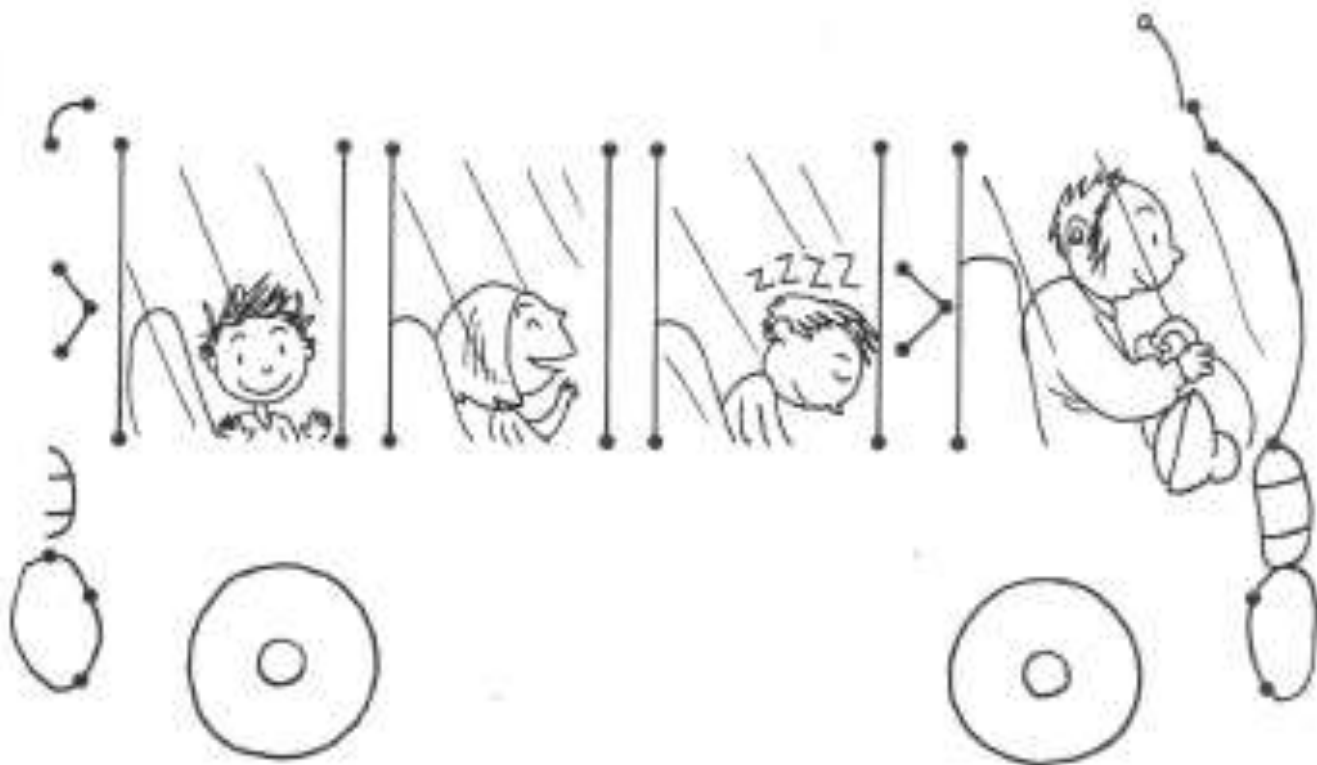
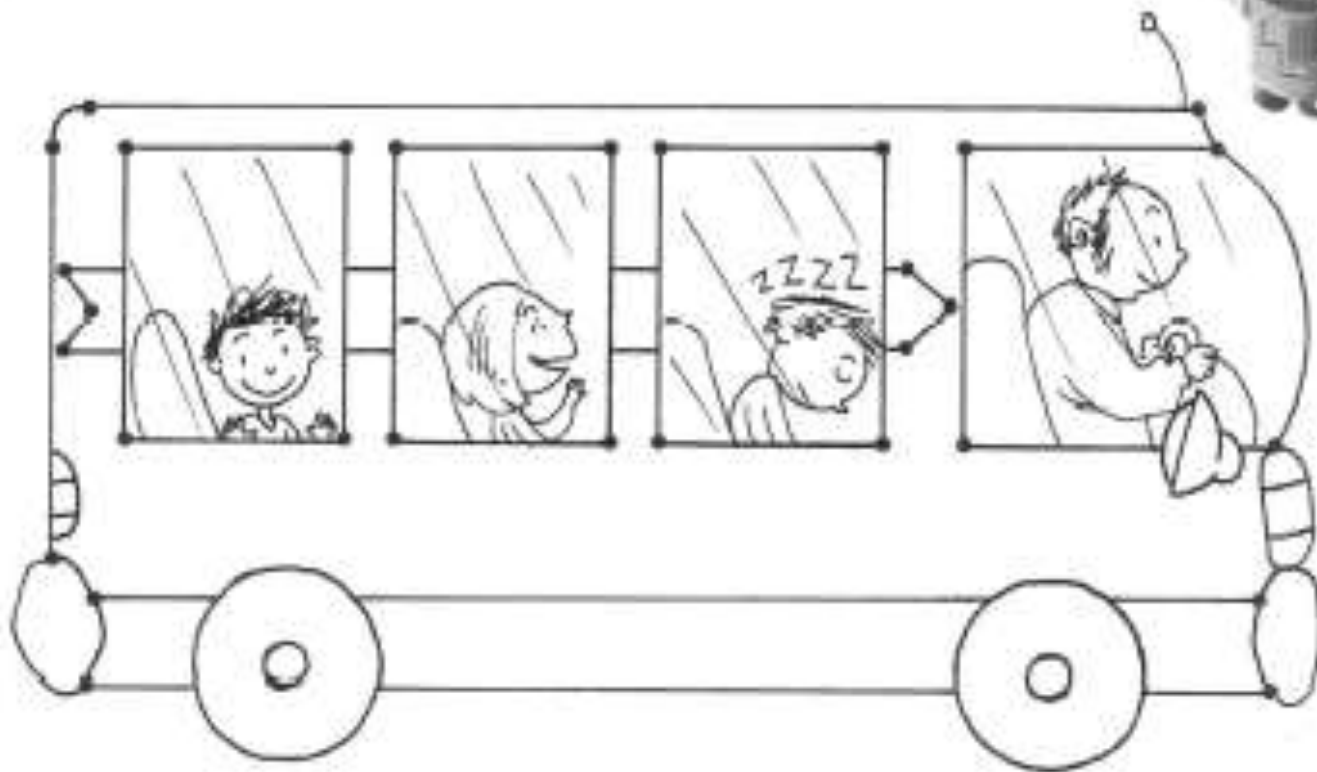

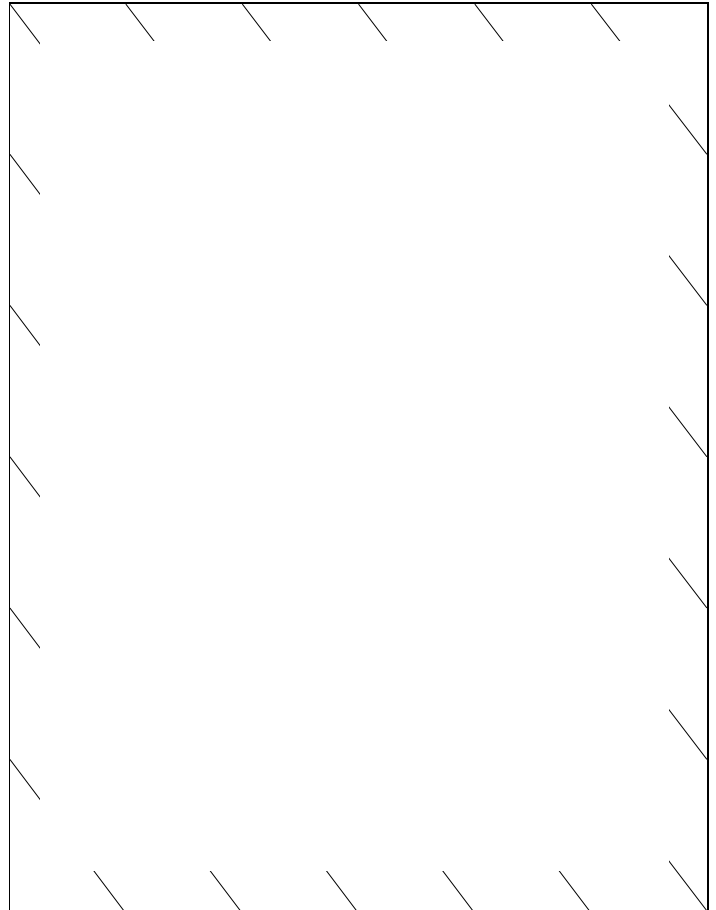
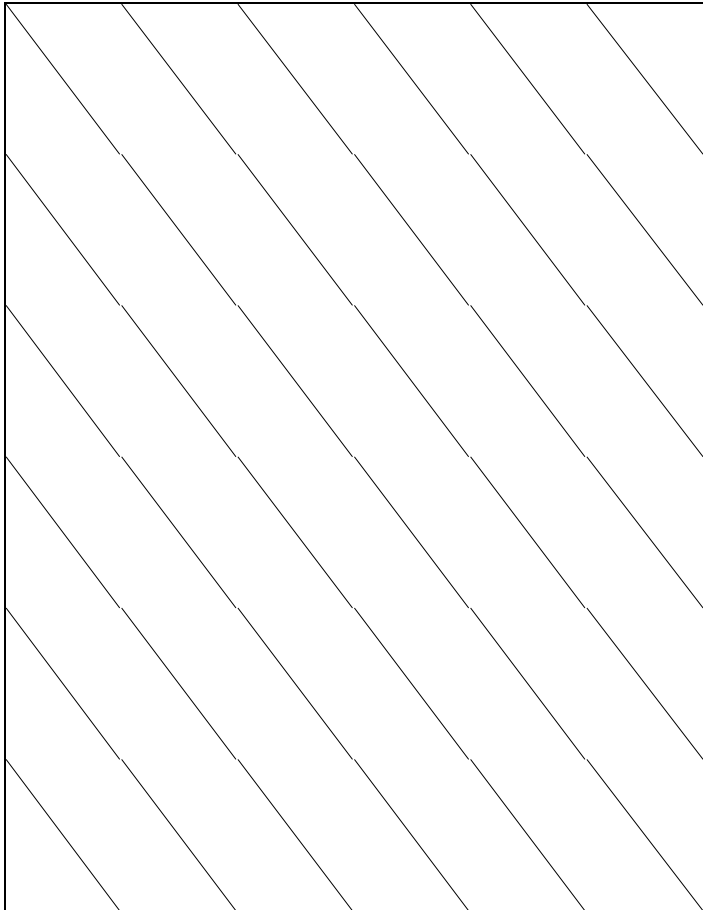
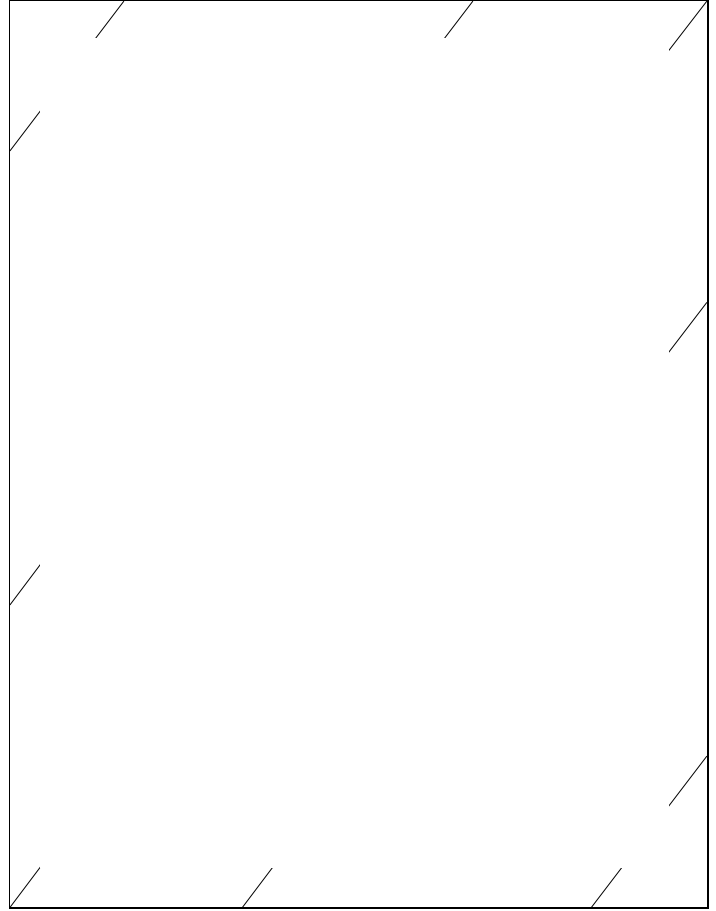
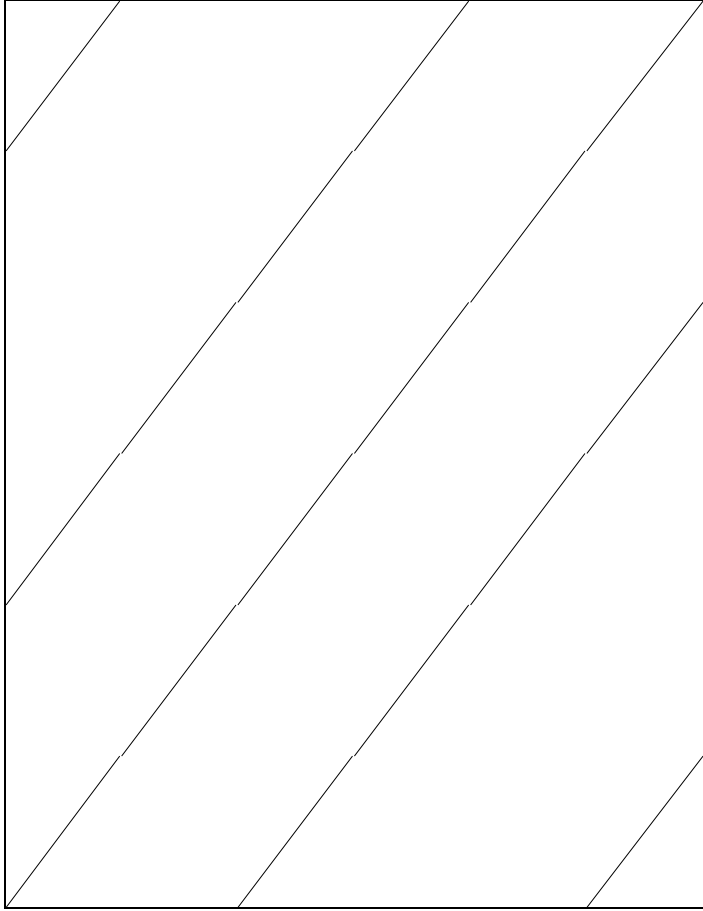

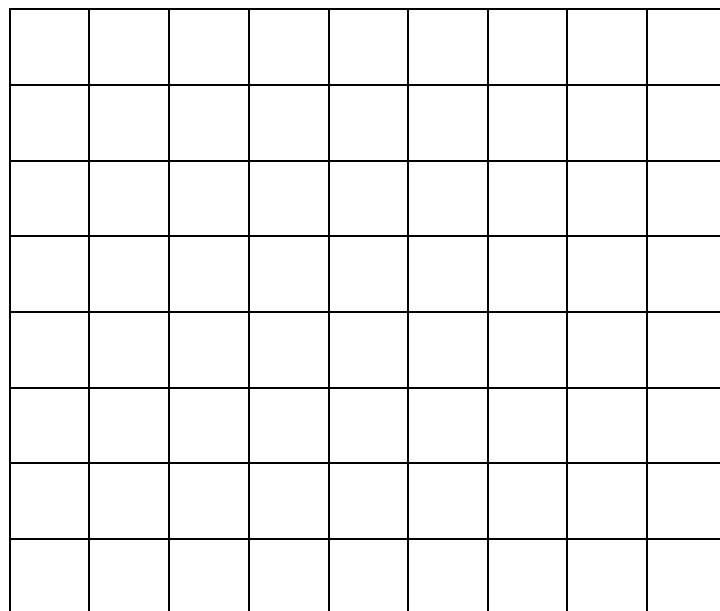
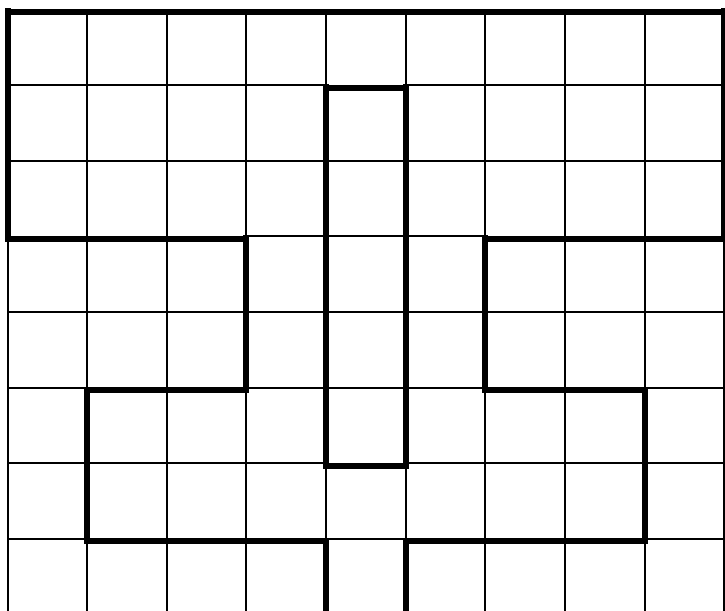
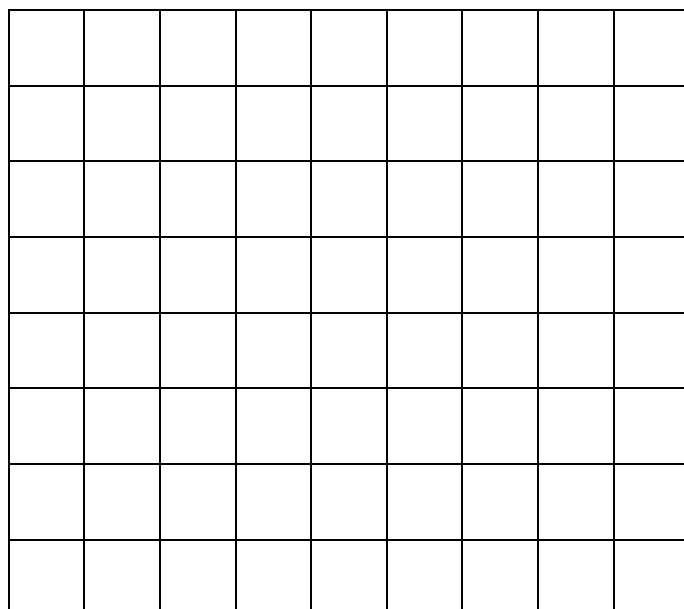
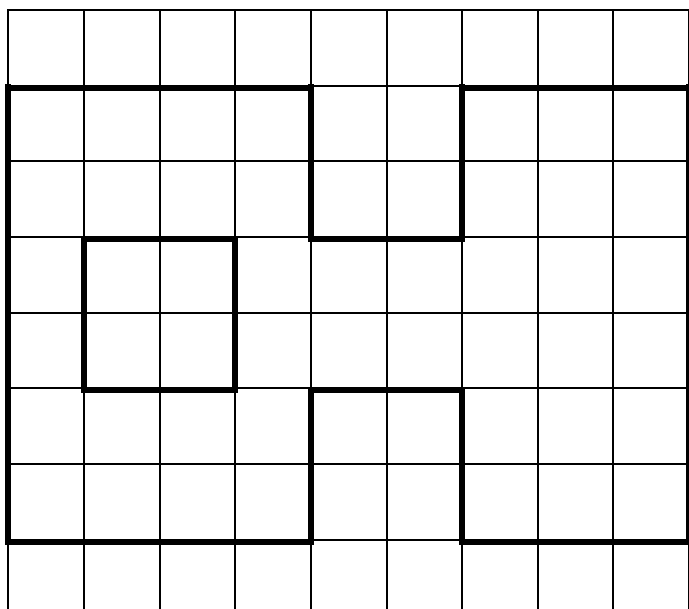
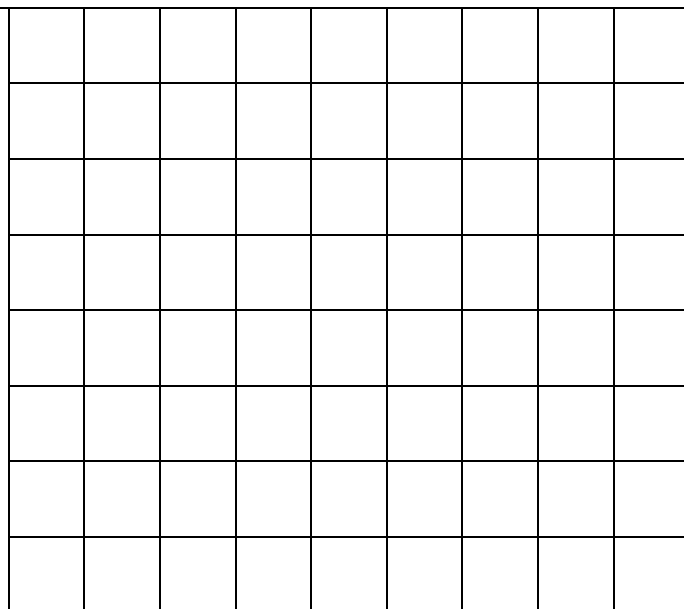
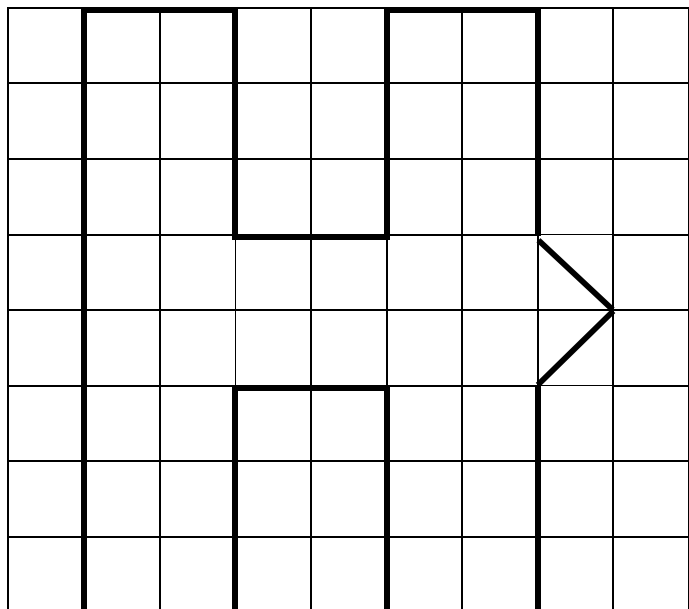

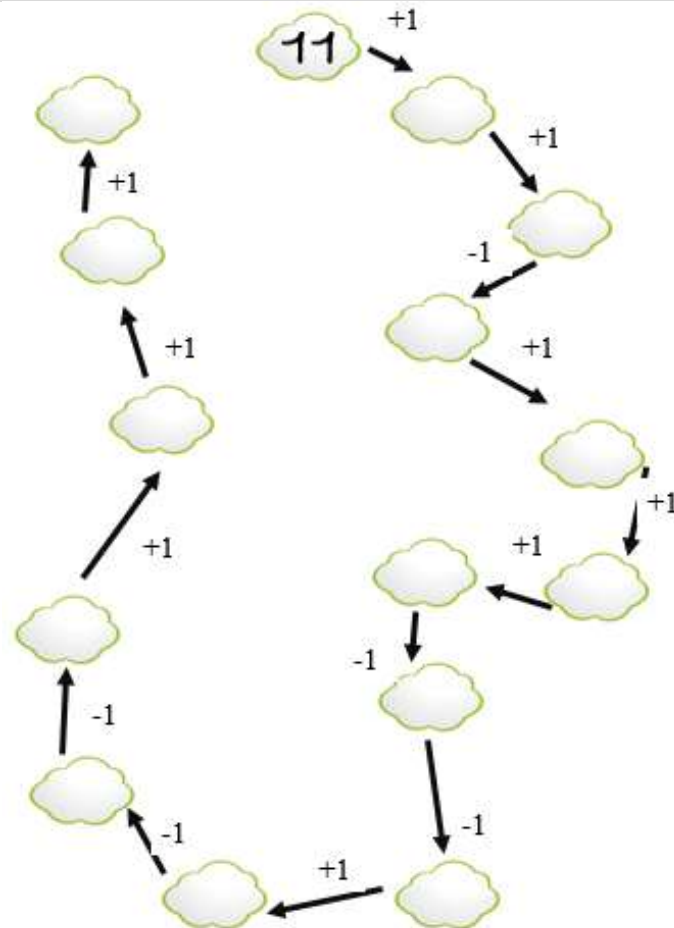
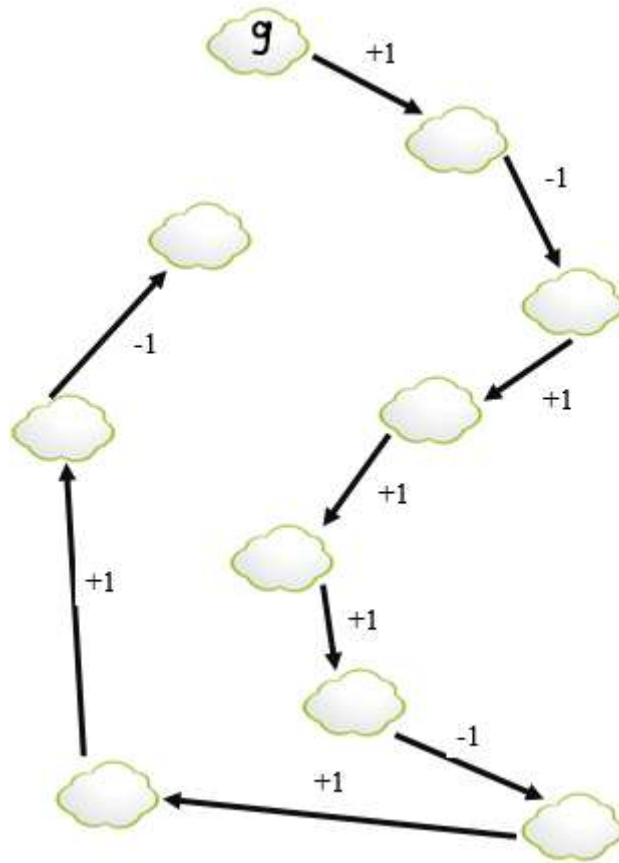

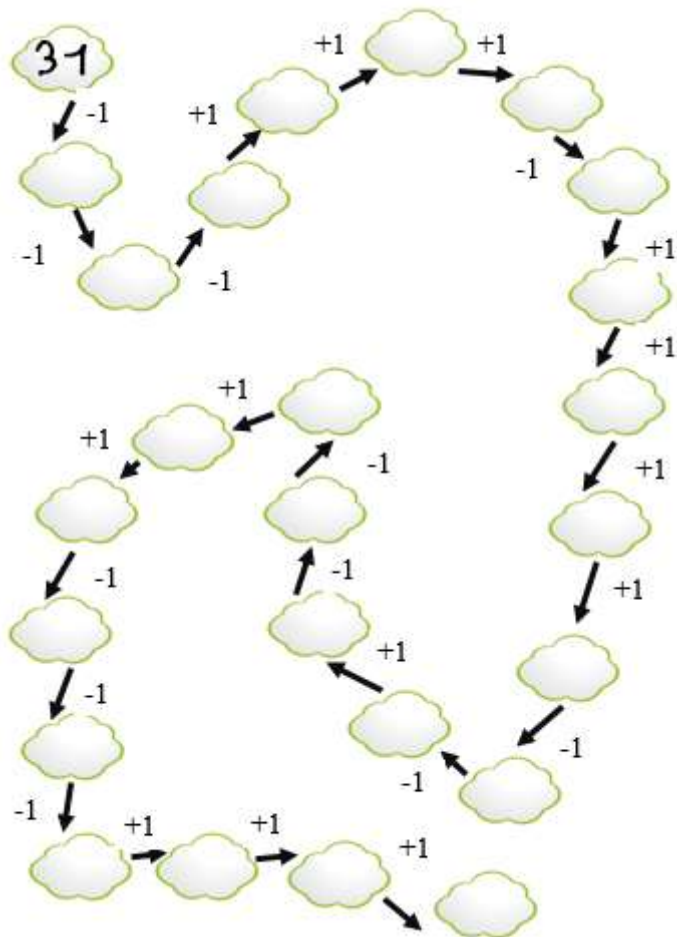
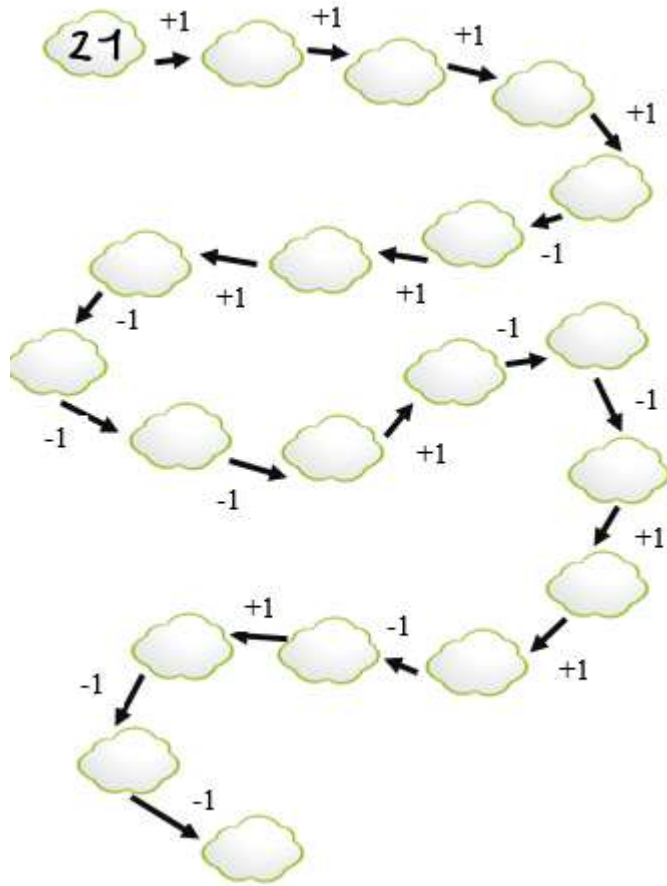

Trace les traits à la règle comme Géom.

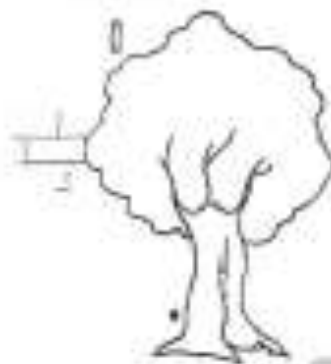
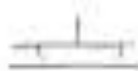
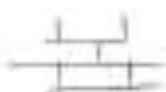
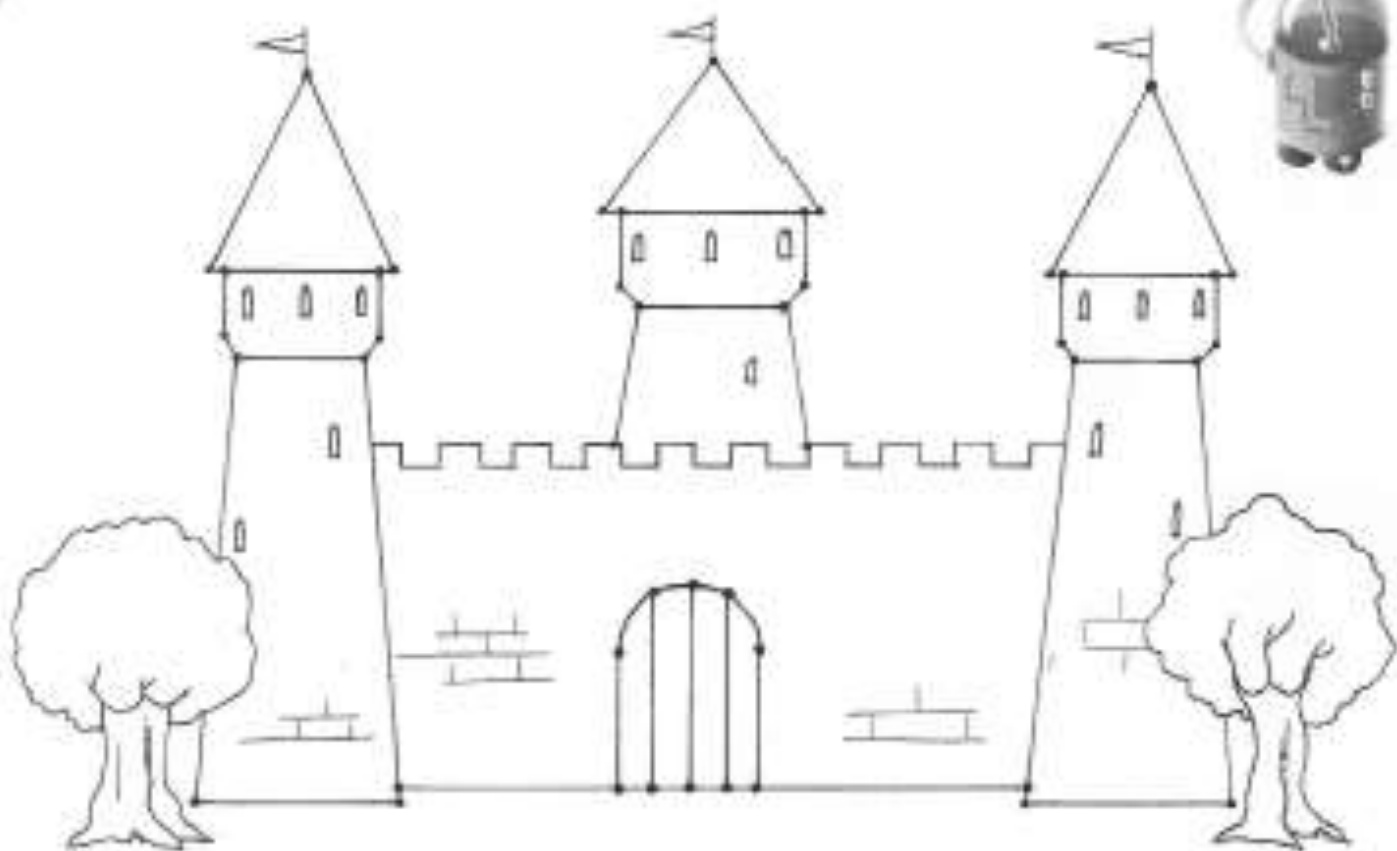



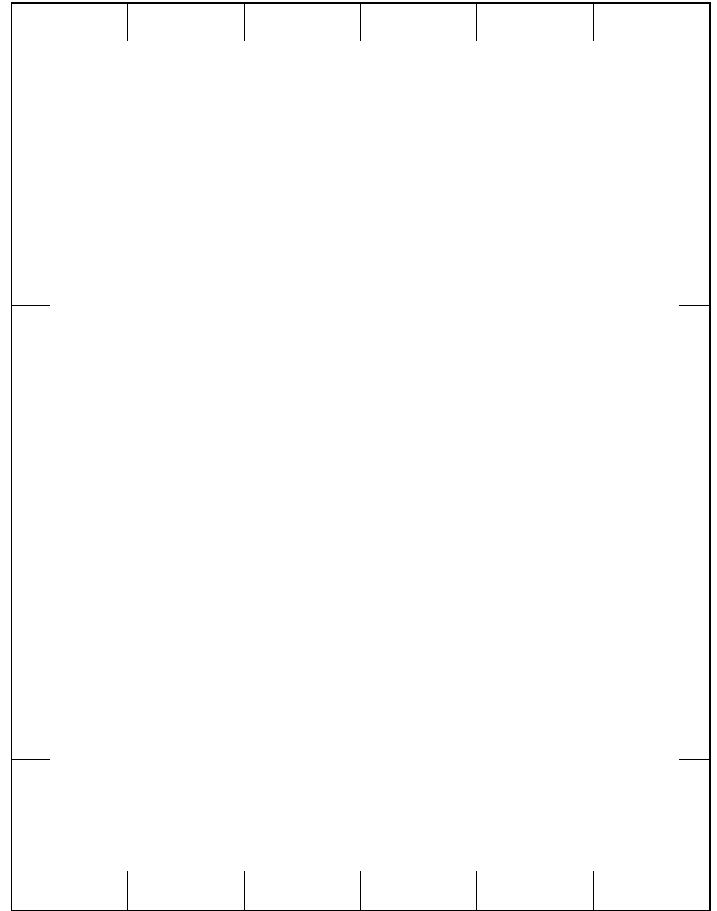

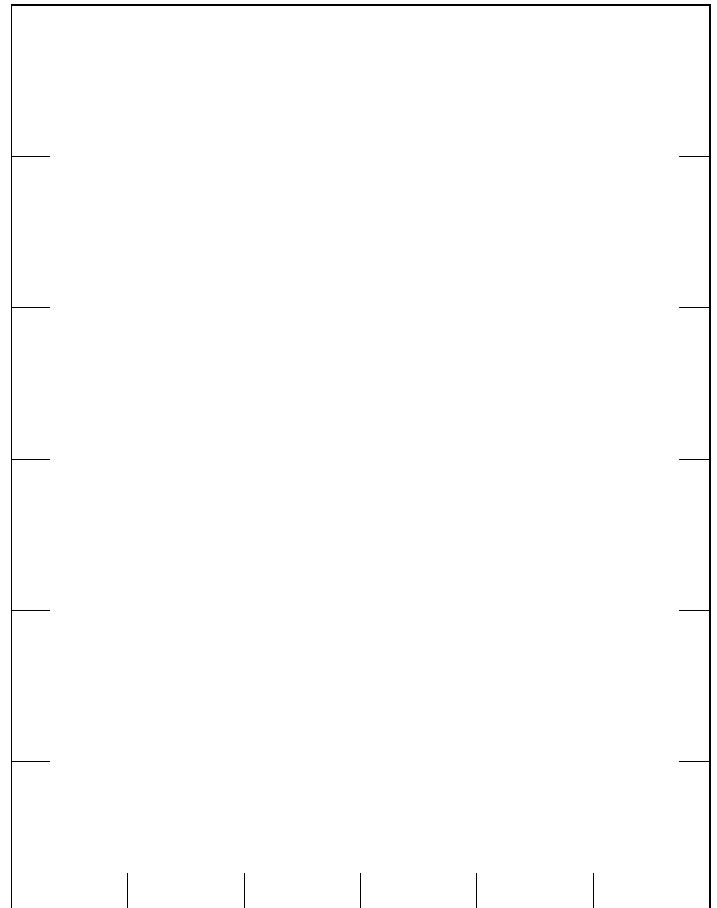

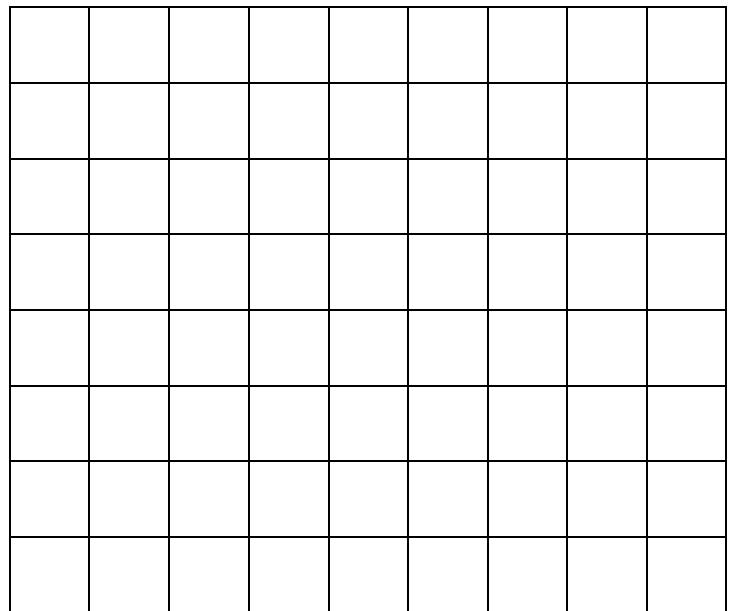
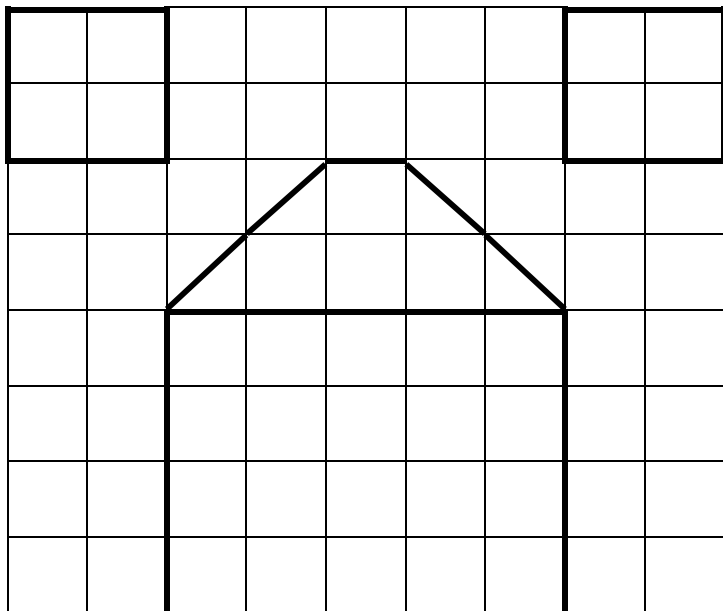
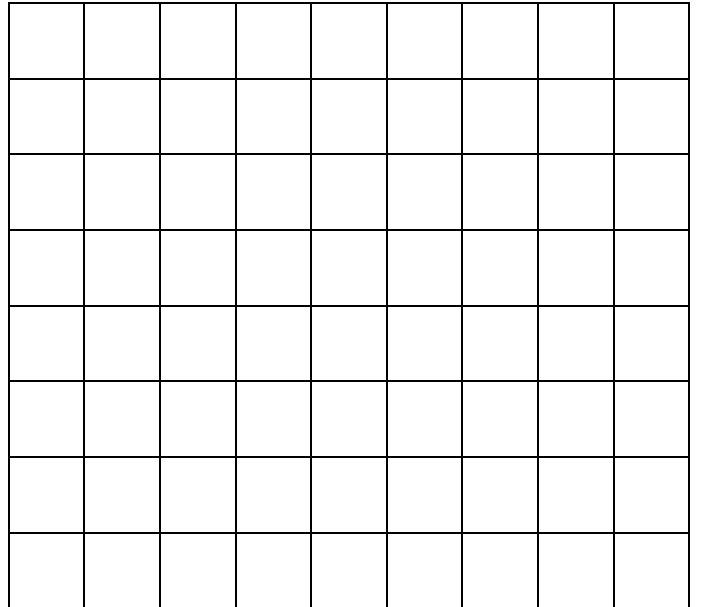
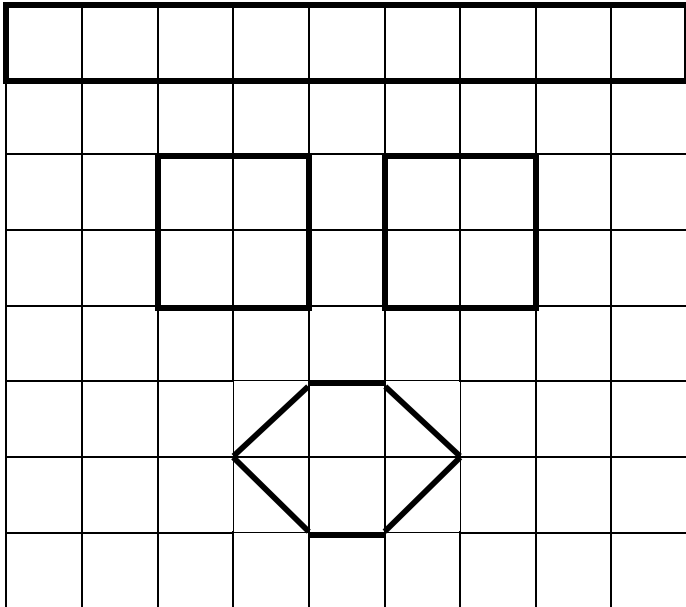
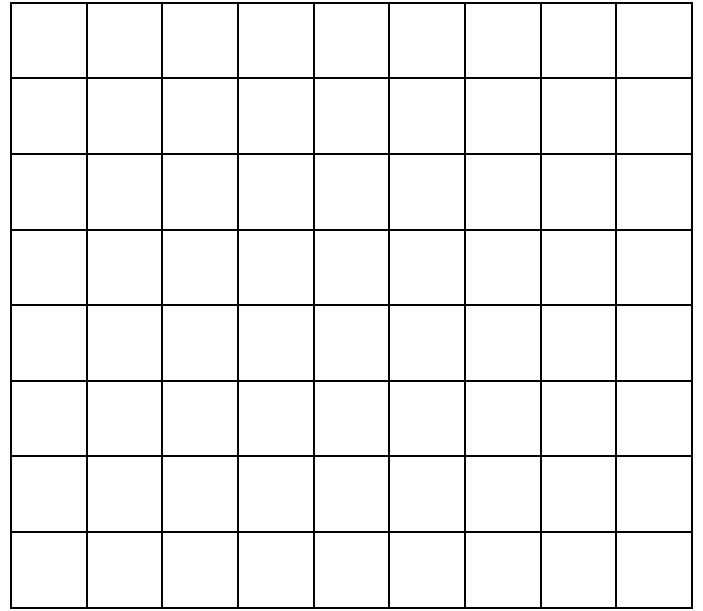
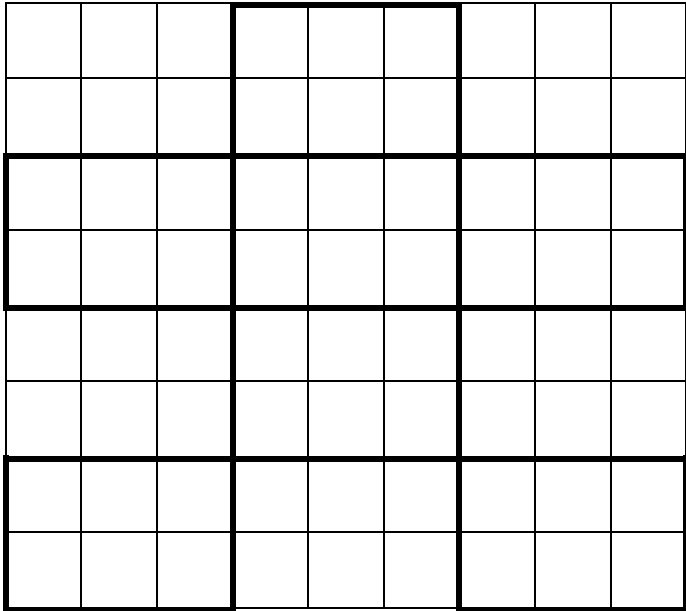



Dessine les groupes et indique le total.

Dessine 3 groupes de 2 jetons.

Total :

Dessine 5 groupes de 5 jetons.

Total :

Dessine 4 groupes de 10 jetons.

Total :



Dessine les groupes et indique le total.

Dessine 6 groupes de 2 jetons.

Total :

Dessine 3 groupes de 5 jetons.

Total :

Dessine 6 groupes de 10 jetons.

Total :

Dessine 4 groupes de 10 jetons.

Total :



Calcule en comptant de 2 en 2 ou de 5 en 5

$$2 + 2 + 2 + 2 =$$

$$5 + 5 + 5 =$$

$$2 + 2 + 2 + 2 + 2 + 2 + 2 =$$

$$5 + 5 + 5 + 5 + 5 =$$

$$2 + 2 + 2 + 2 + 2 =$$

$$5 + 5 + 5 + 5 + 5 + 5 + 5 =$$

$$2 + 2 + 2 + 2 + 2 + 2 + 2 + 2 + 2 =$$

$$5 + 5 + 5 + 5 =$$



Calcule les additions suivantes

$$10 + 10 + 10 + 2 + 2 =$$

$$10 + 10 + 10 =$$

$$10 + 10 + 10 + 10 + 10 + 5 =$$

$$10 + 10 + 10 + 5 =$$

$$10 + 10 + 2 + 2 + 2 + 2 =$$

$$10 + 10 + 10 + 10 + 10 =$$

$$10 + 10 + 5 + 5 + 5 + 2 + 2 =$$

$$10 + 10 + 5 + 2 =$$

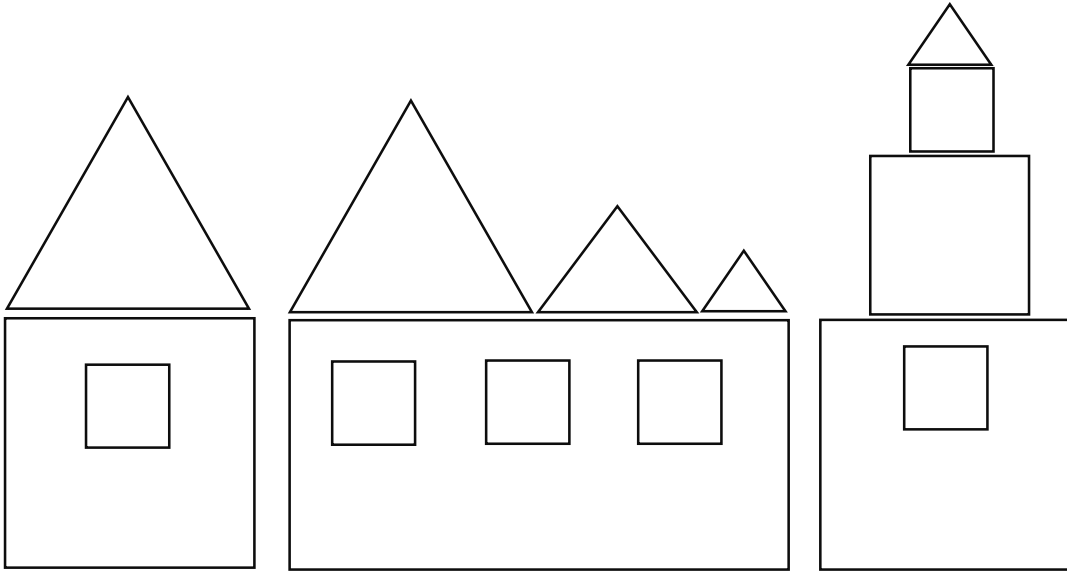

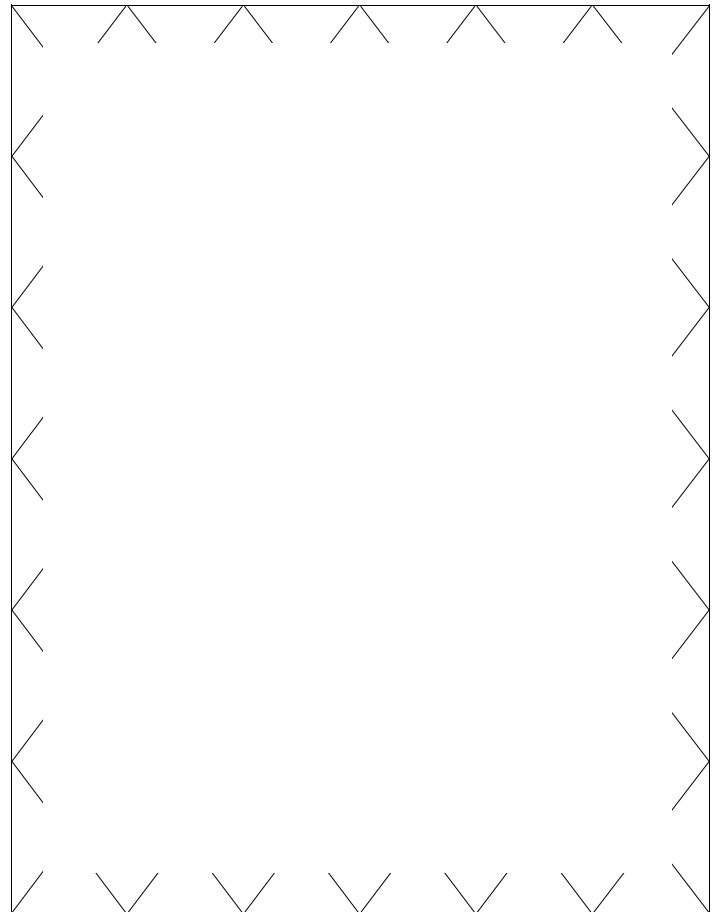
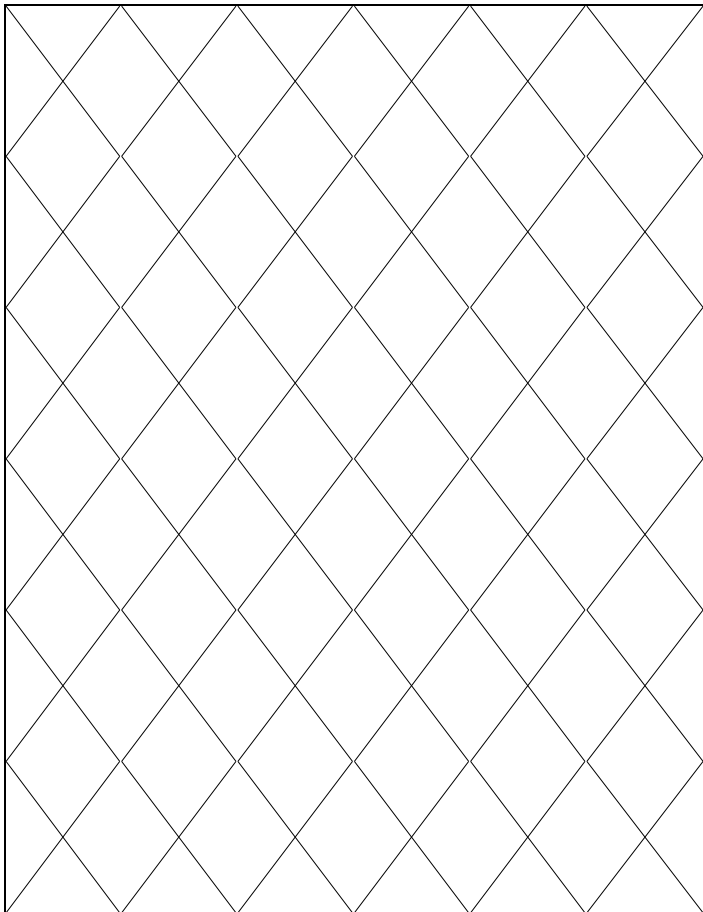
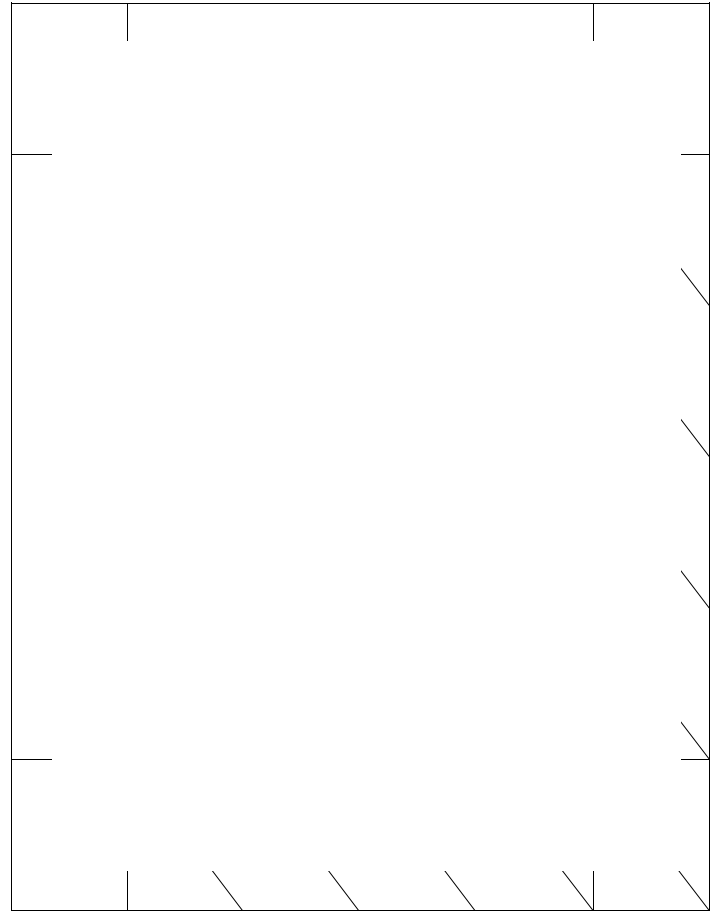
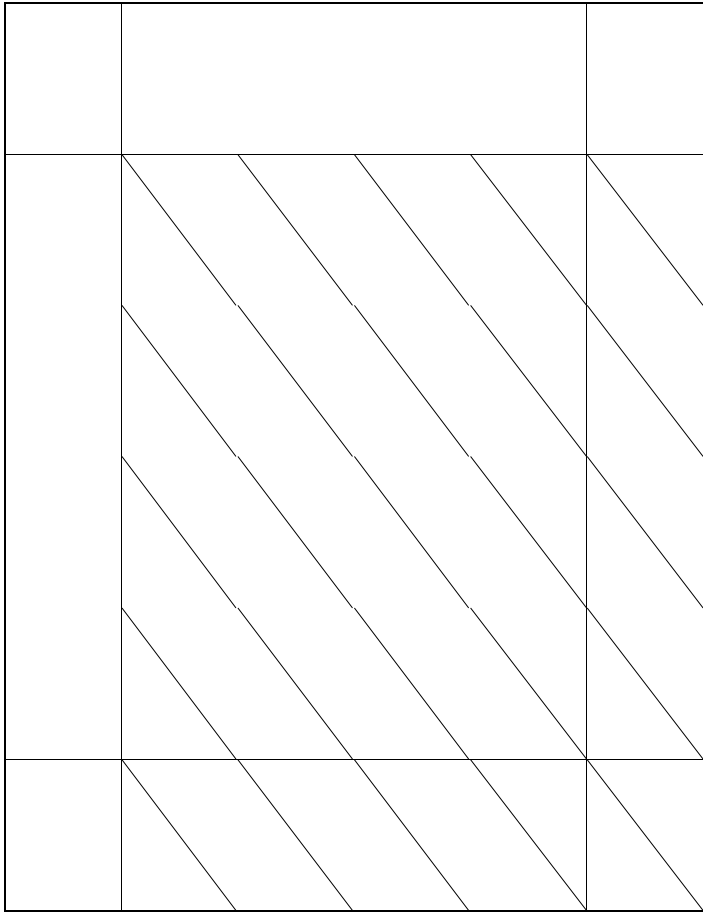

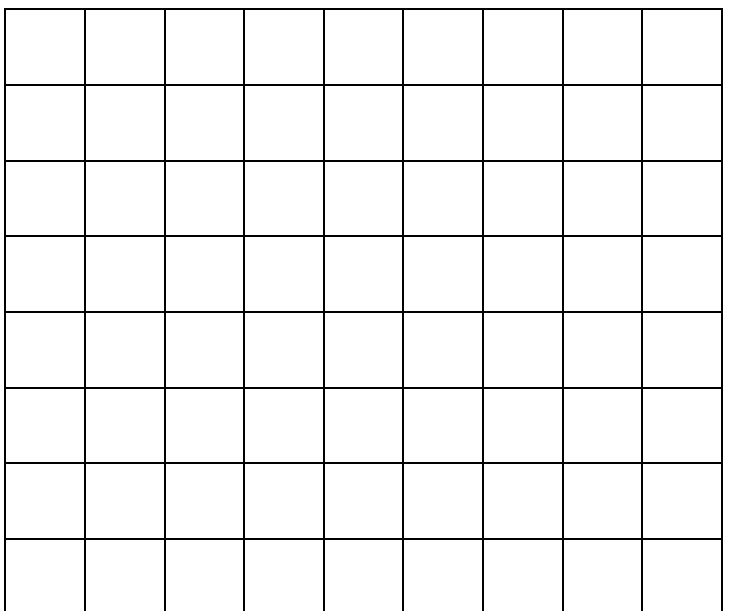
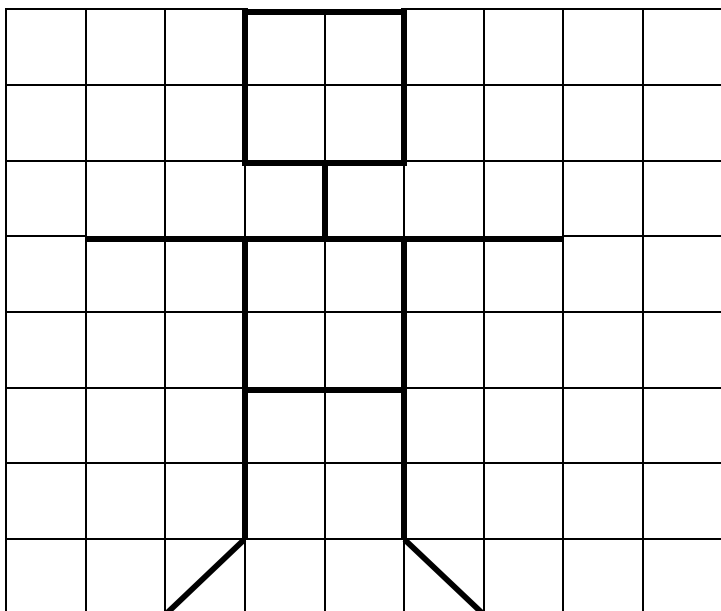
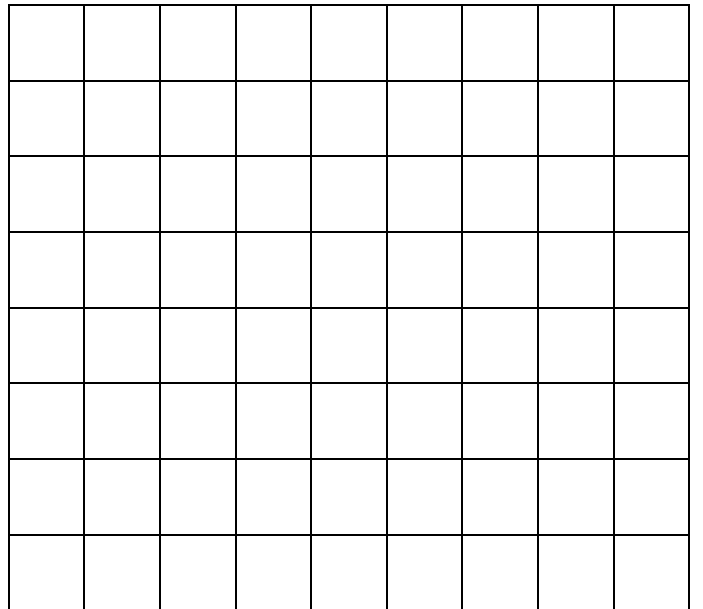
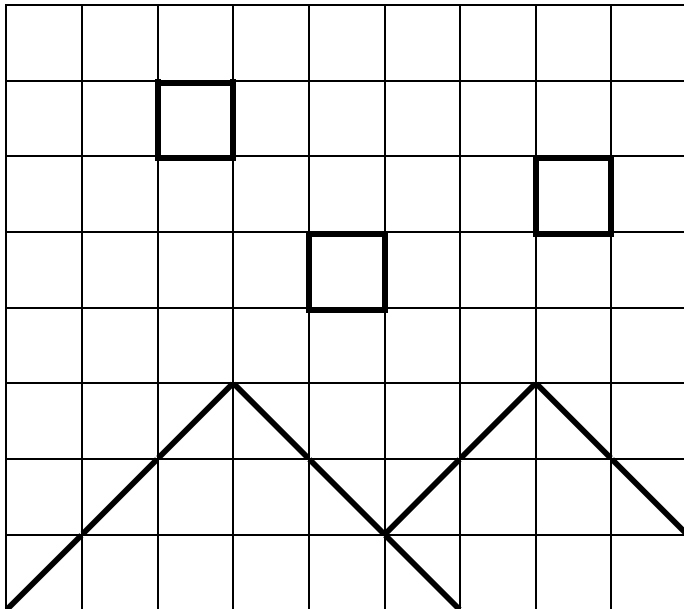
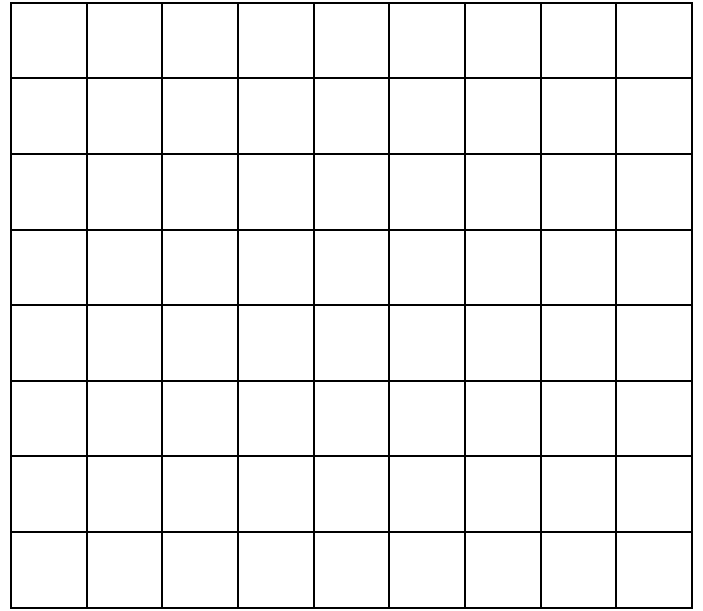
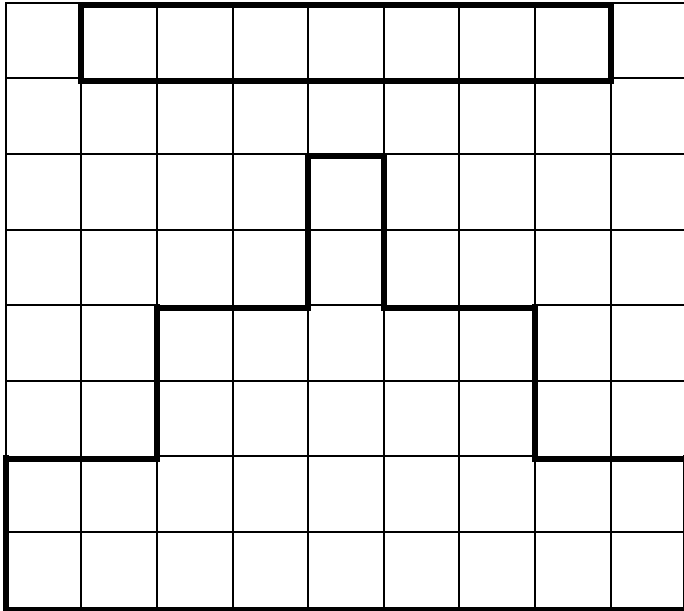



10	11	12	13	14	15	16	17	18	19
----	----	----	----	----	----	----	----	----	----

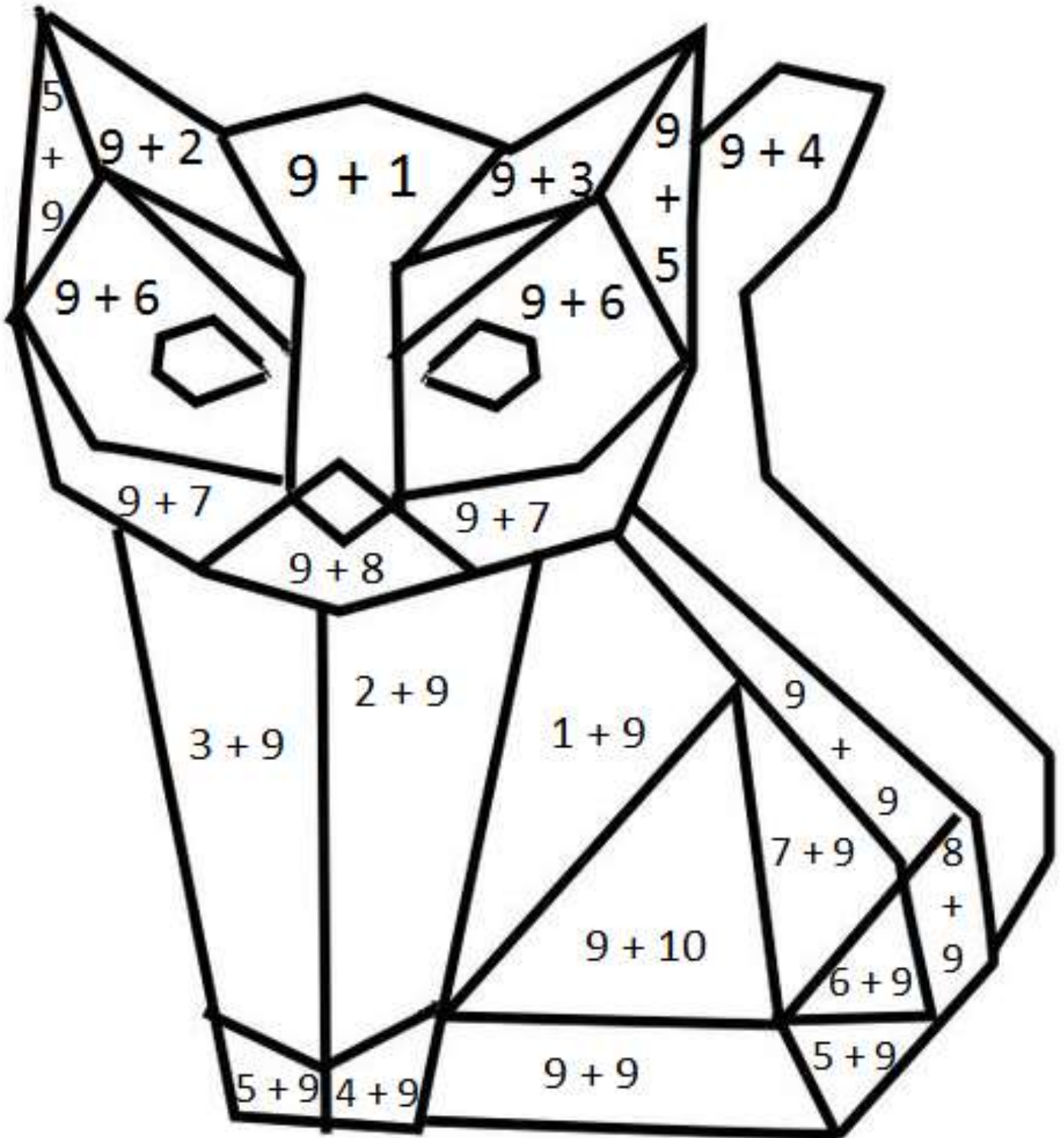

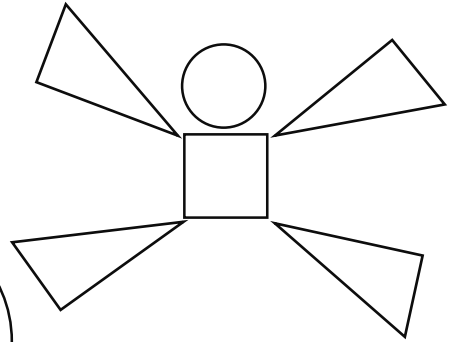
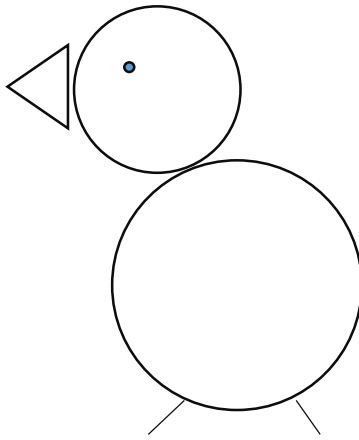
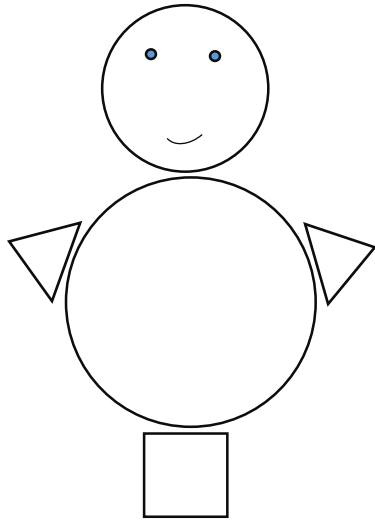

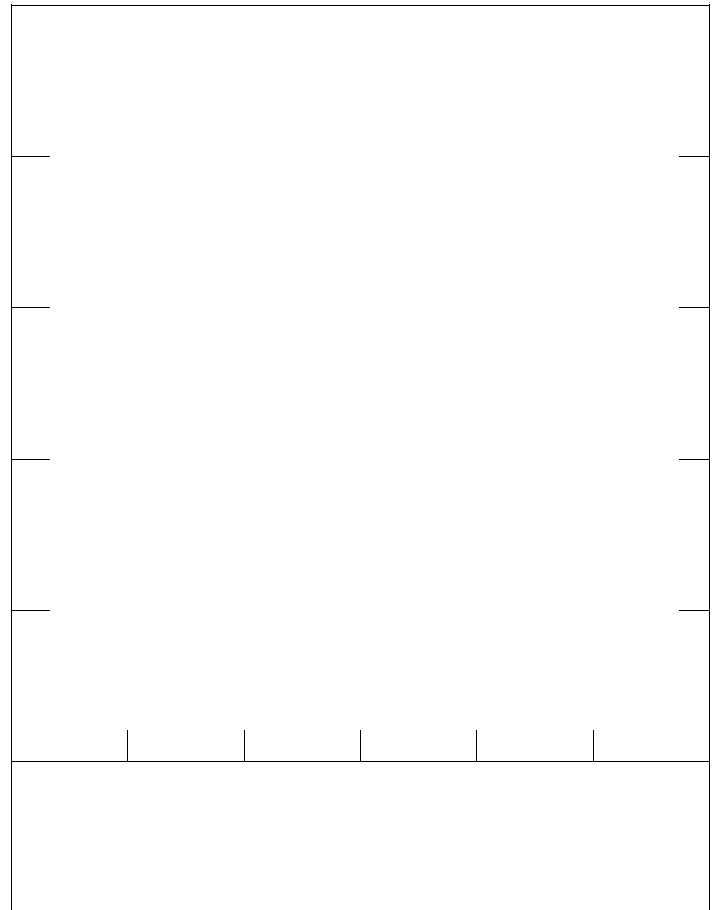
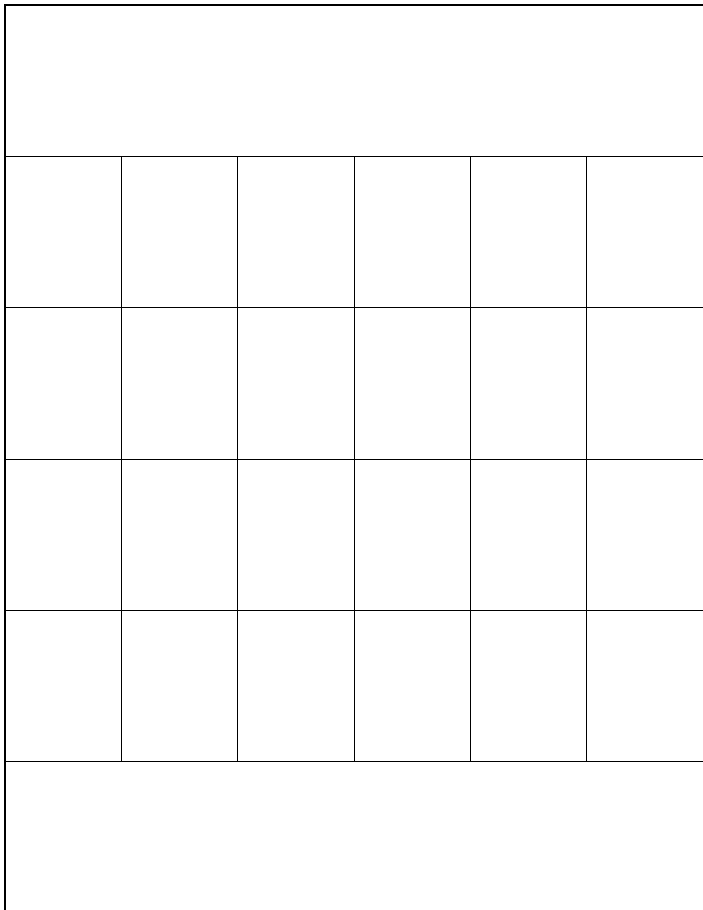
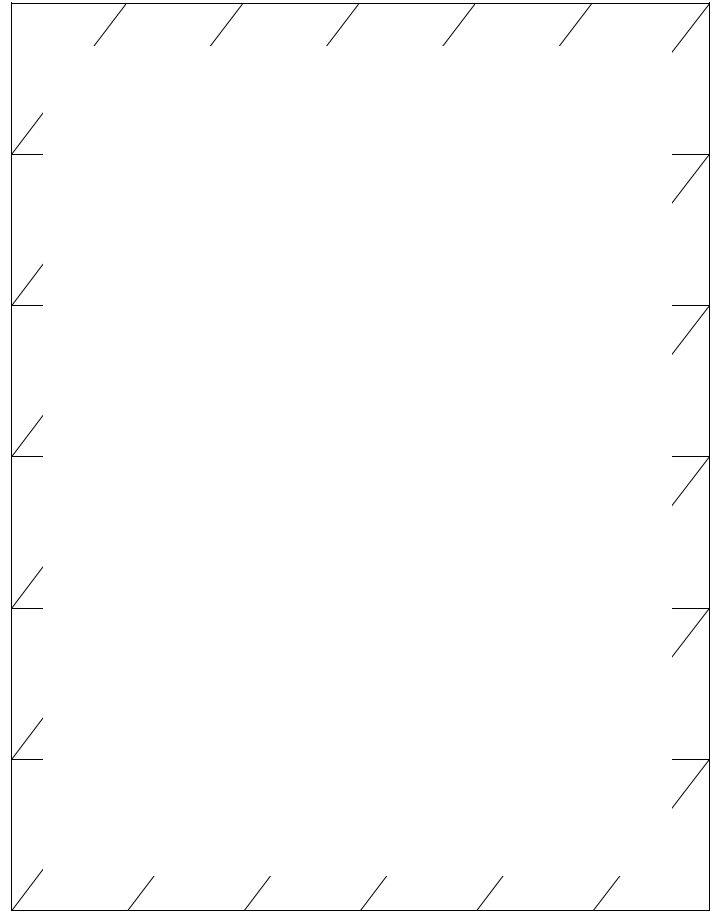
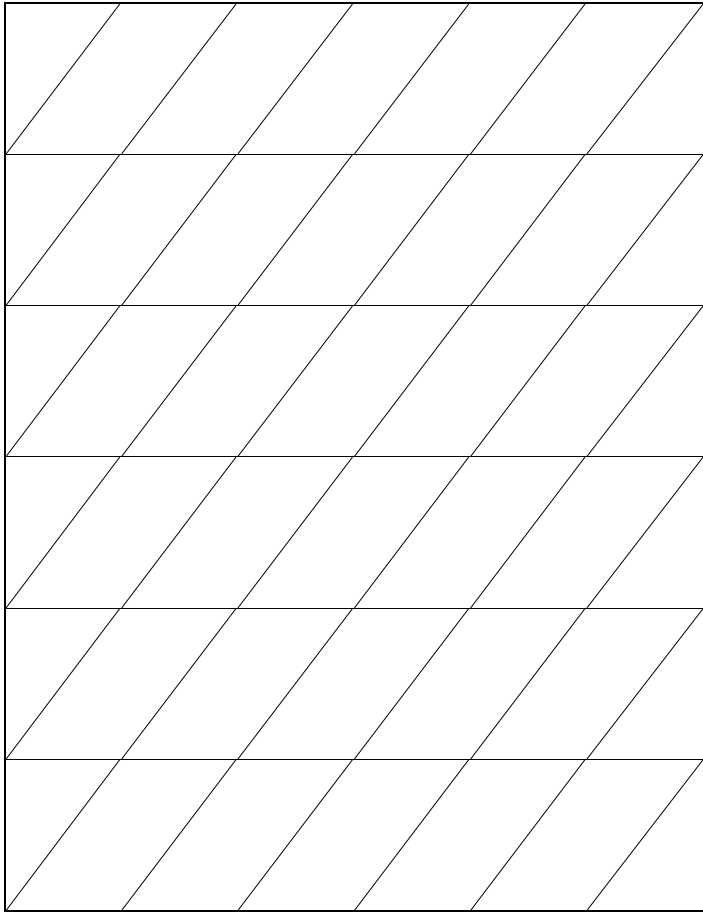

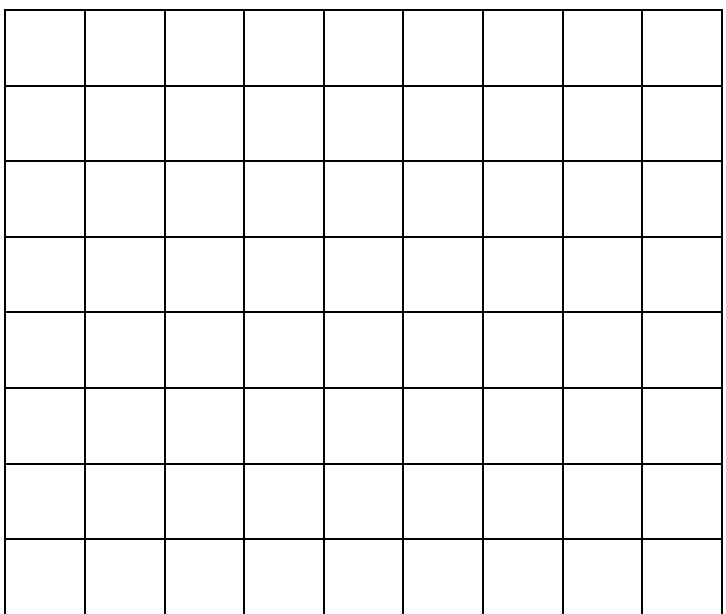
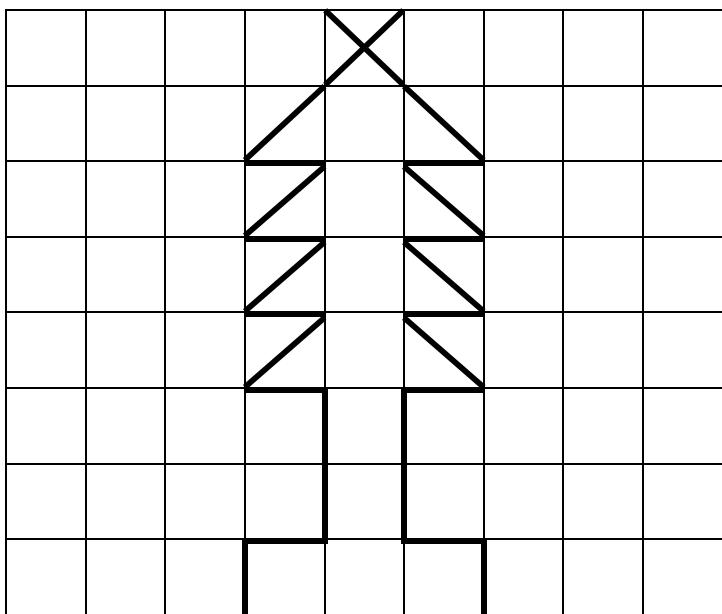
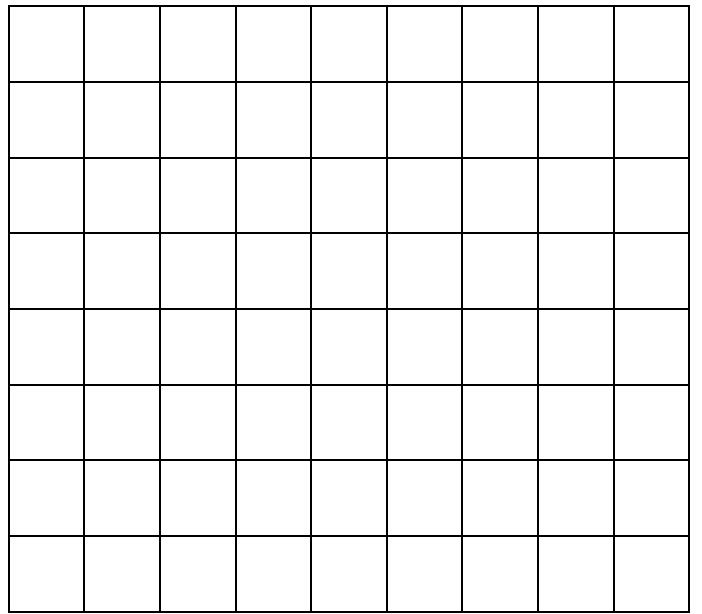
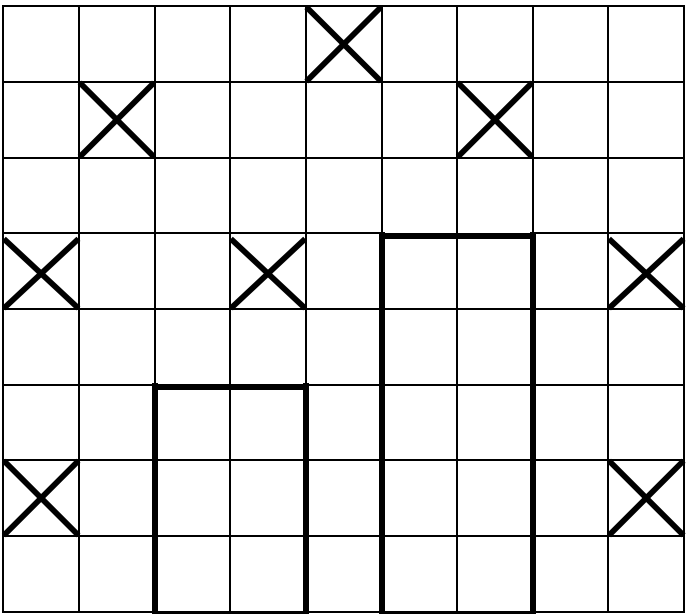
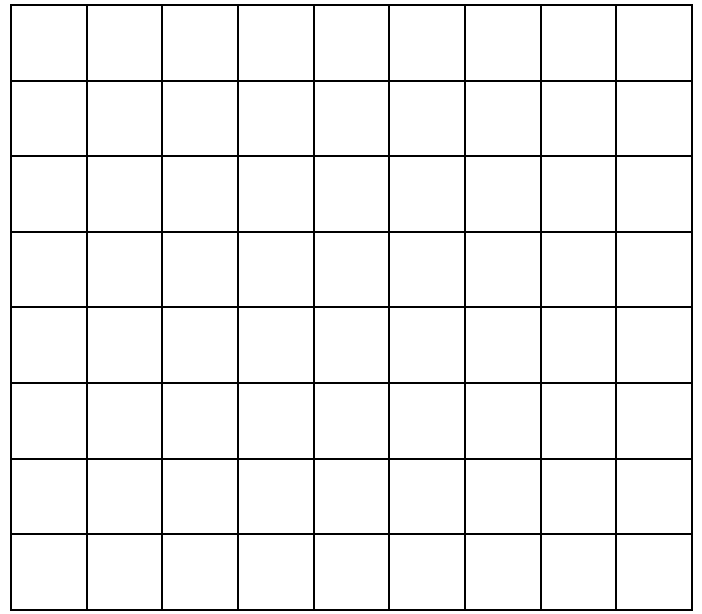
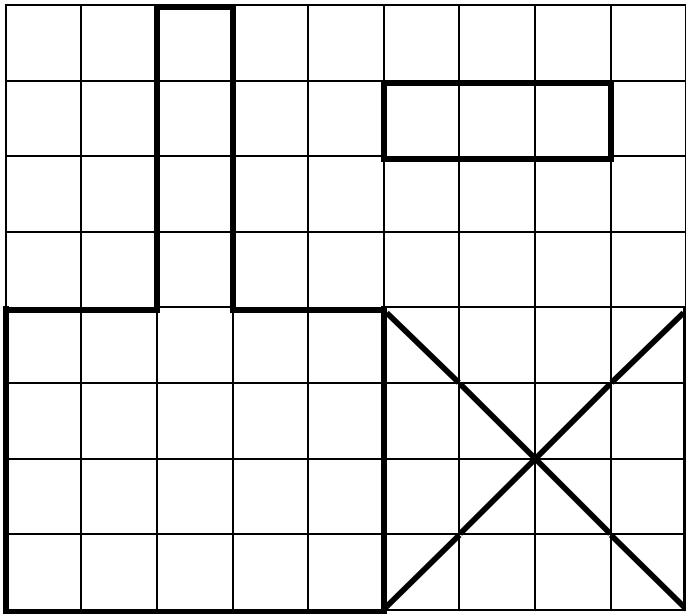



Résous les opérations suivantes en t'aidant de ton sous-

main

$14 + 10 =$	$25 + 30 =$
$32 + 10 =$	$39 + 40 =$
$28 + 40 =$	$27 + 30 =$
$13 + 30 =$	$15 + 30 =$



Résous les opérations suivantes en t'aidant de ton sous-

main

$28 + 20 =$	$36 + 20 =$
$45 + 6 =$	$47 + 10 =$
$25 + 4 =$	$28 + 50 =$
$31 + 6 =$	$32 + 30 =$



Résous les opérations suivantes en t'aidant de ton sous-
main

$53 + 9 =$	$19 + 20 =$
$63 + 7 =$	$68 + 10 =$
$31 + 4 =$	$17 + 50 =$
$24 + 30 =$	$43 + 30 =$



Résous les opérations suivantes en t'aidant de ton sous-
main

$32 + 40 =$	$26 + 20 =$
$52 + 8 =$	$25 + 10 =$
$73 + 5 =$	$19 + 50 =$
$62 + 8 =$	$13 + 40 =$

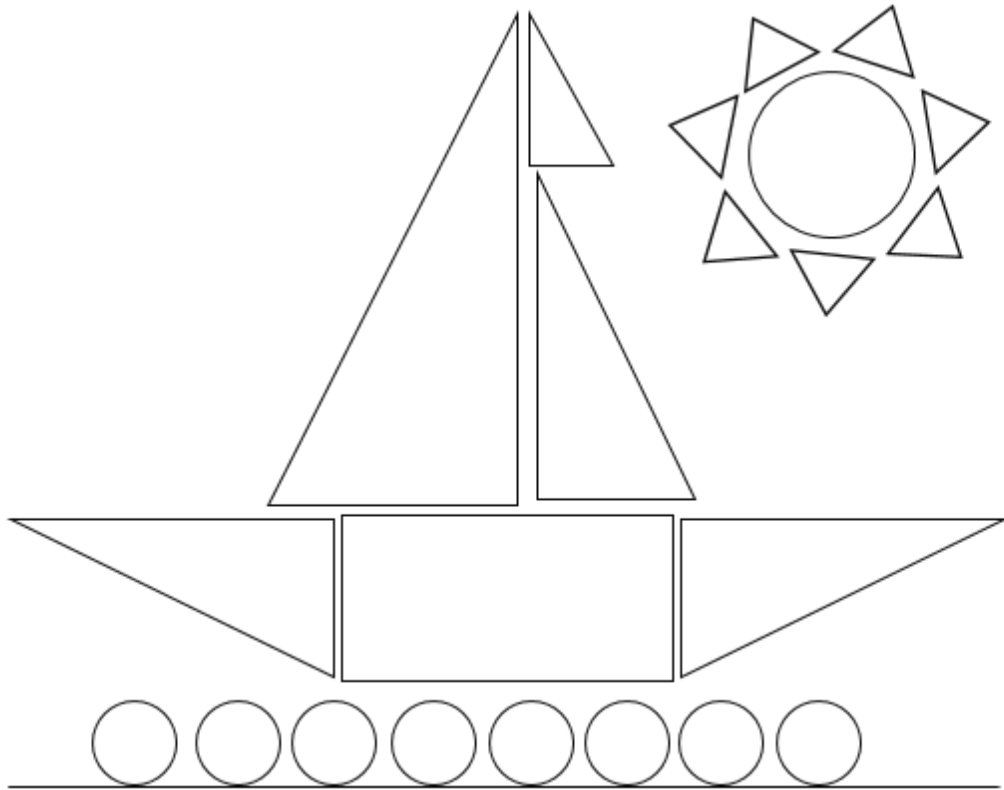

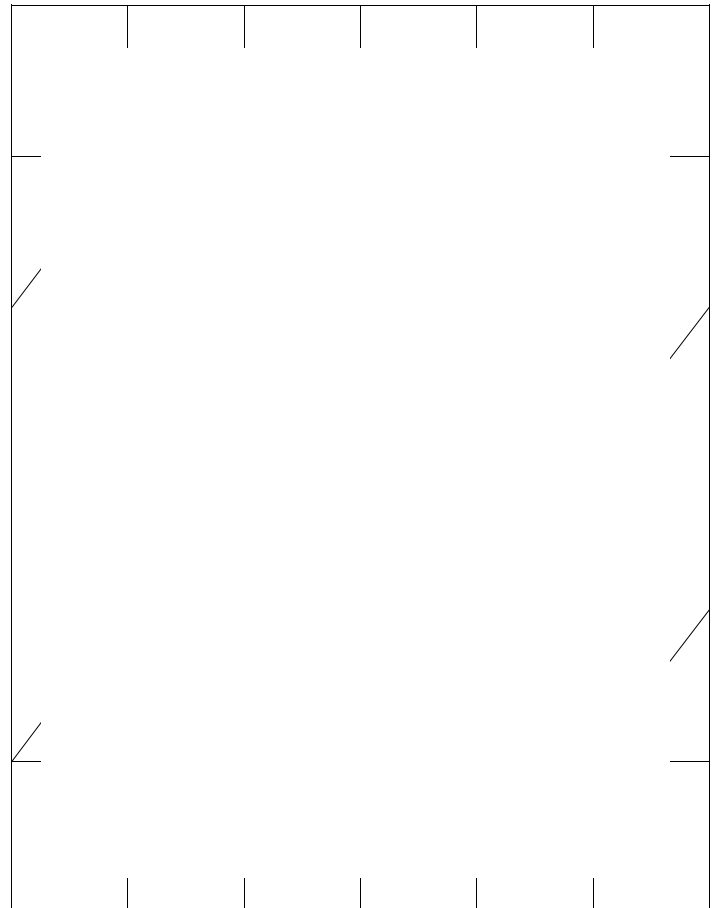
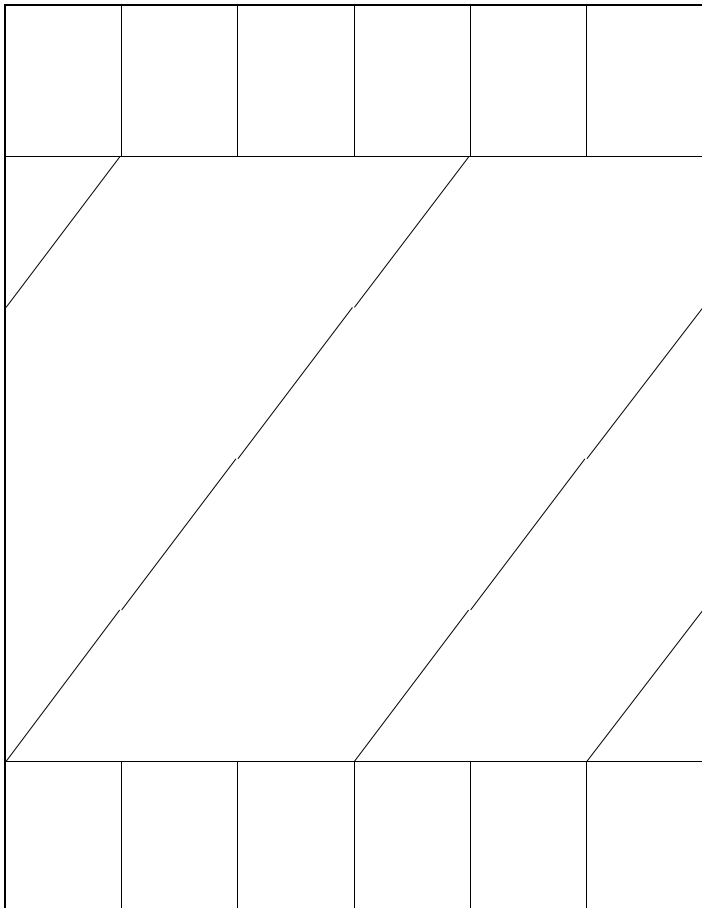
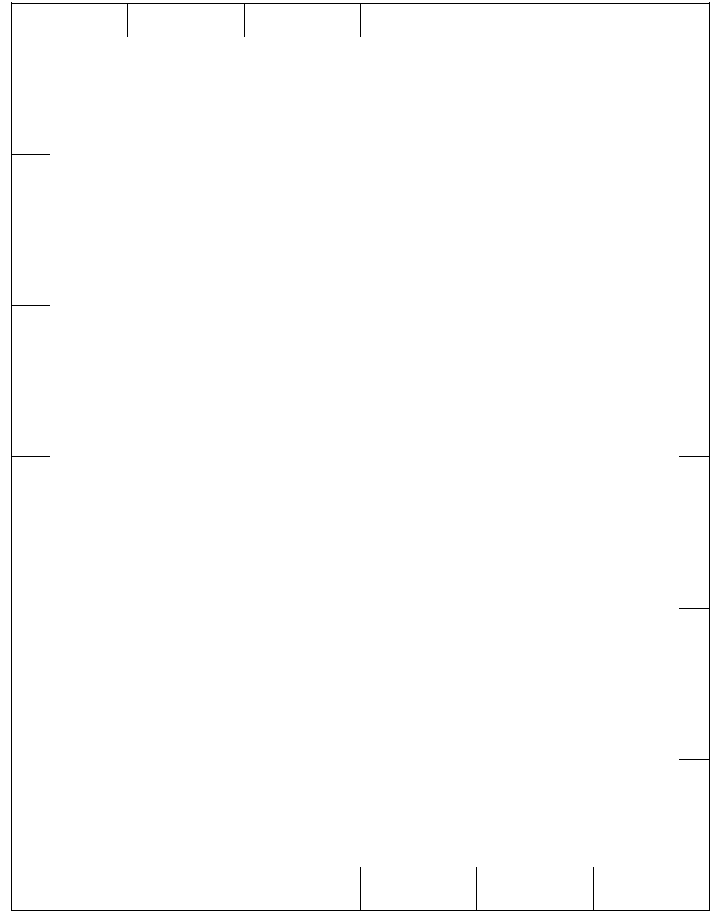
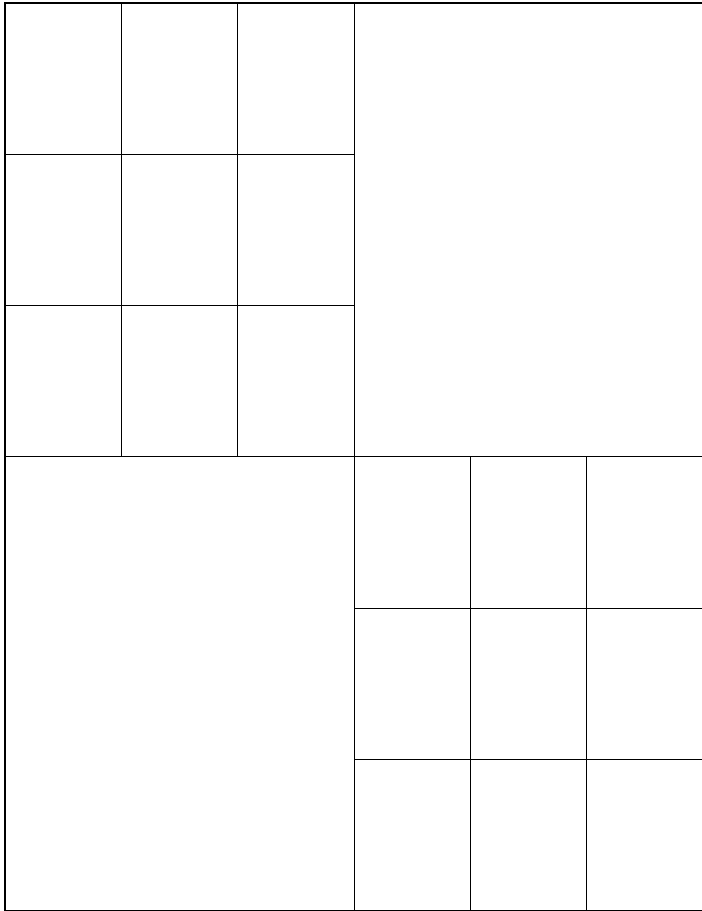

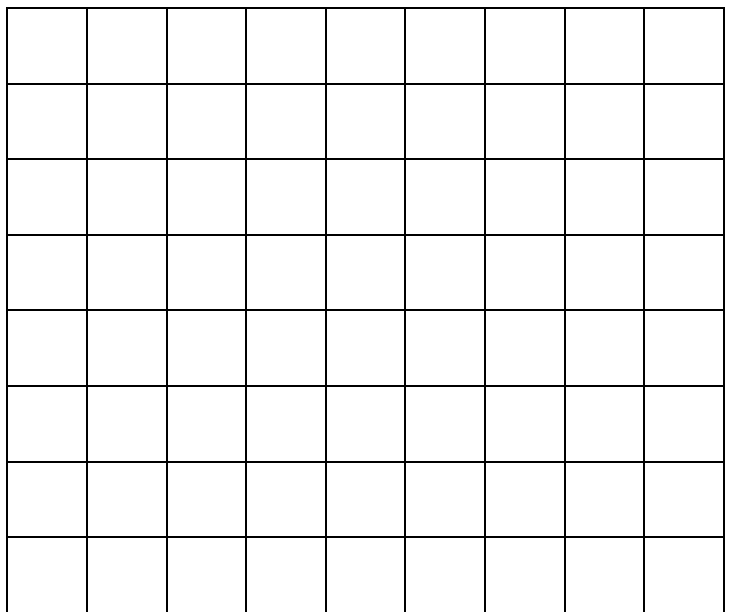
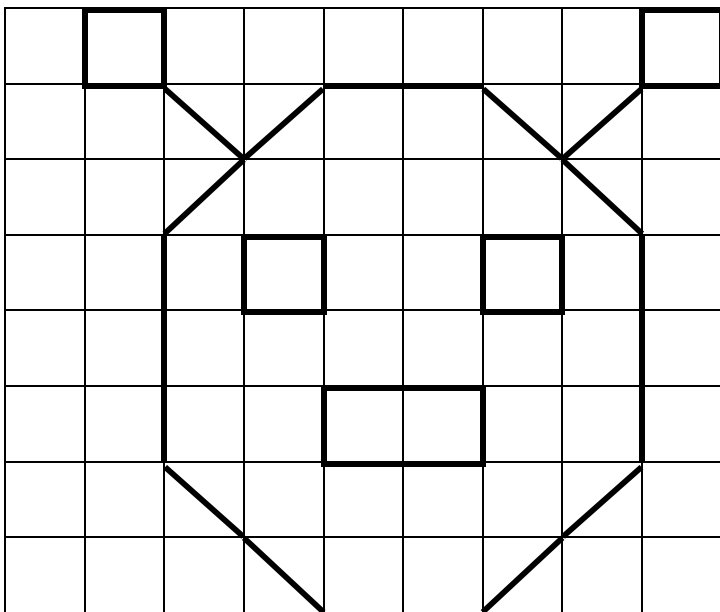
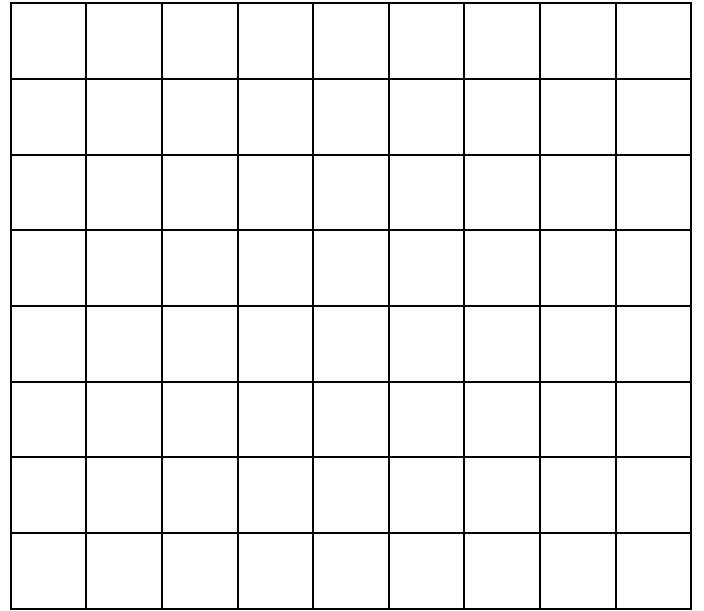
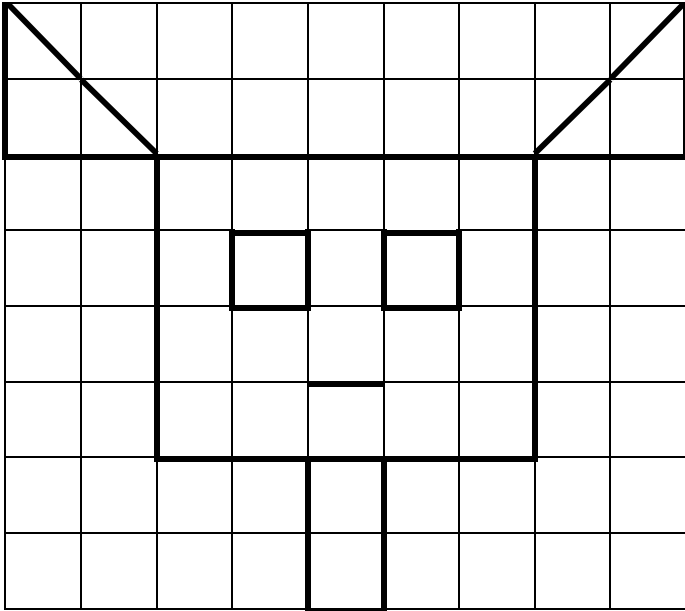
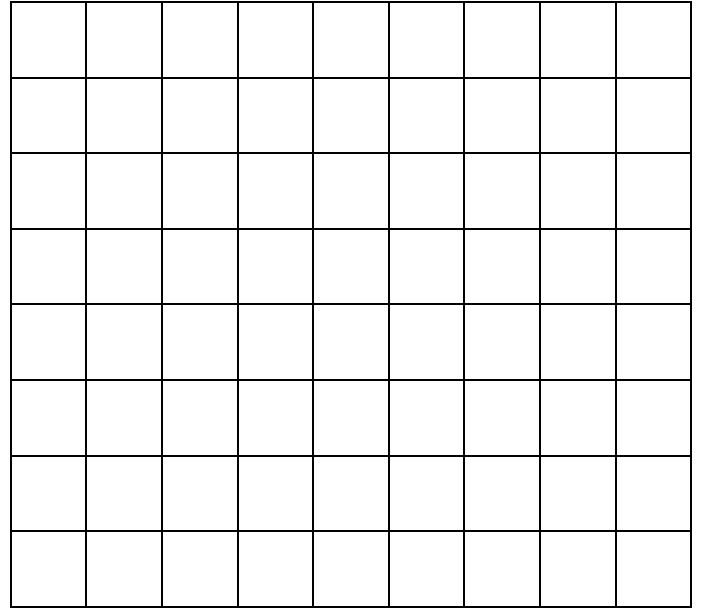
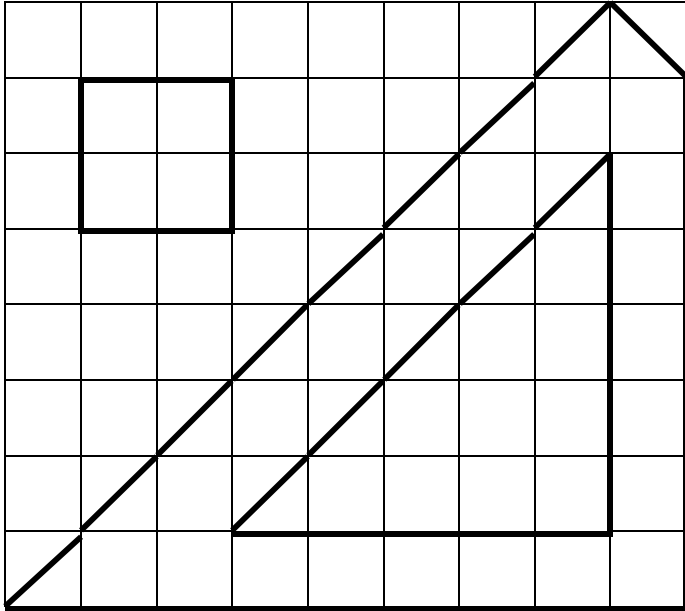

Complète avec les nombres manquants.

1				5					10
11				15	16			19	20
	22				26		28	29	
31			34			37	38		40
	42			45	46		48		50
51		53	54		56	57		59	
				65			68		
		72						79	

Calcule les additions suivantes

$10 + 10 + 10 + 2 =$	$10 + 10 + 10 + 5 + 2 + 2 =$
$10 + 10 + 5 =$	$10 + 10 + 10 + 10 + 10 + 5 + 5 =$ $=$
$10 + 10 + 10 + 10 + 10 + 2 + 2 =$ $=$	$10 + 10 + 10 + 2 + 2 + 2 + 2 =$
$10 + 10 + 10 + 5 + 2 =$	$10 + 10 + 5 + 5 + 5 + 5 + 2 =$

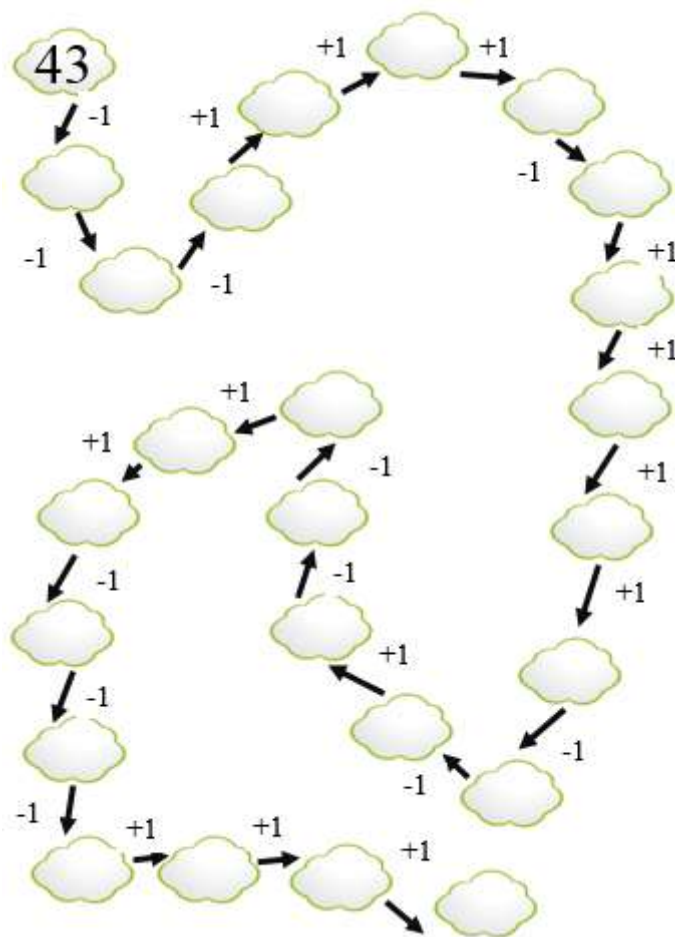

Complète :

a. Complète.

Il y a bouteilles mais il n'y a que bouchons.



b. Écris, interprète et calcule la soustraction.

c. Vérifie (relie et entoure) et **écris** une « phrase solution ».

a. Complète.

Il y a enfants mais il n'y a que crayons.



b. Écris, interprète et calcule la soustraction. - =

c. Vérifie (relie et entoure) et **écris** une « phrase solution ».