

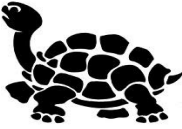

Des sons inversés : car/cra - tar/tra - bor/bro - pil/pli...

## 1. Complète les mots :

Une .....tue 



Un .....gnon de pomme

Une .....son 



Un bateau de .....ates

Une .....de 

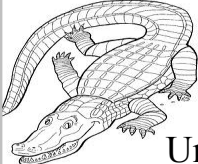

Un .....codile

Il .....e 

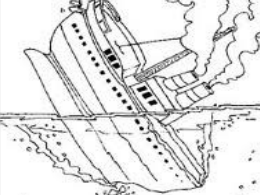

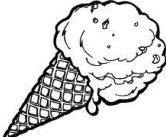

Il .....e

Des .....ets 



Une .....ce

Un .....l 



Une .....me

Un auto..... 





Un .....paud

Un .....ceau  





Des .....tons

De la mou.....de 





Un .....cteur

Un .....lier 

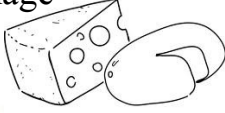

Une .....che

Du .....mage 



De la .....ce

La .....be du père Noël 



Em.....sser

## 2. Écris les noms dans les étiquettes.

