

# Lecture

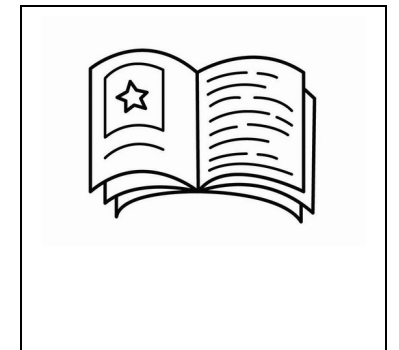

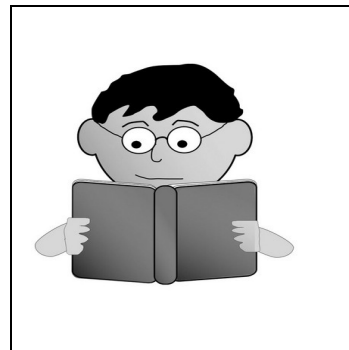

# Lecture

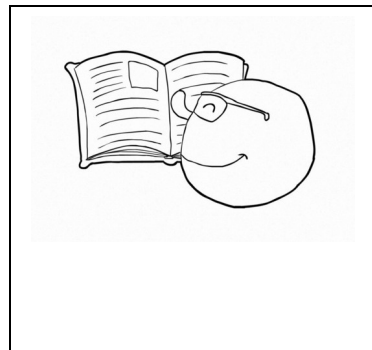
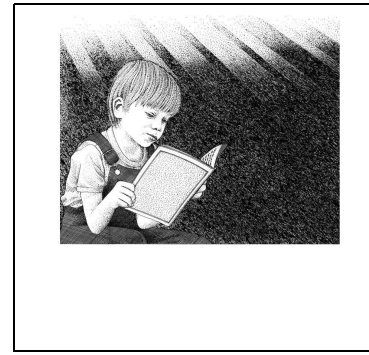
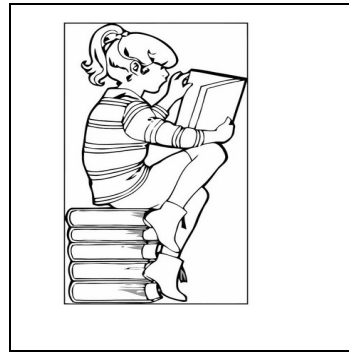
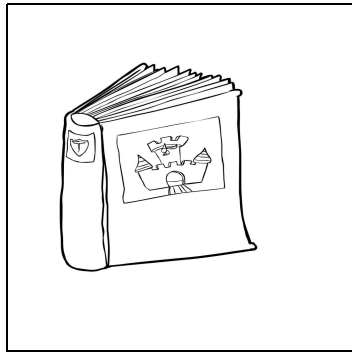
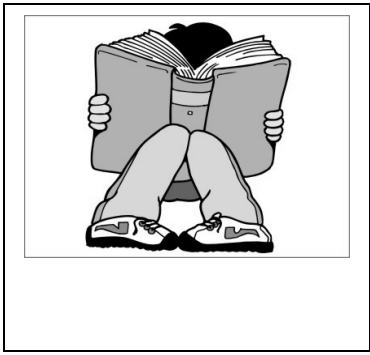
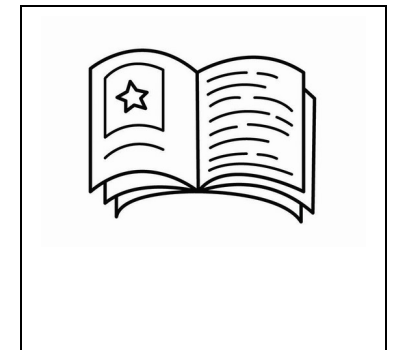
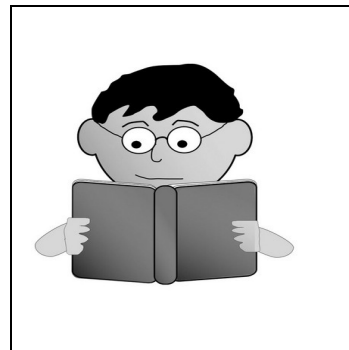
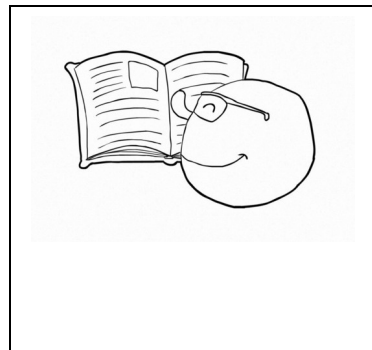

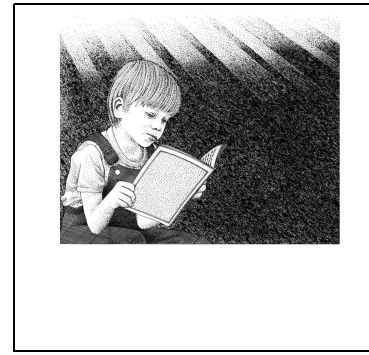
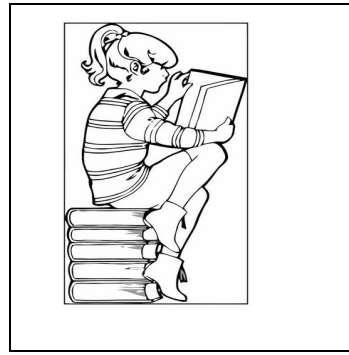
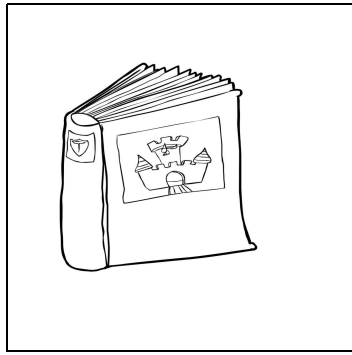
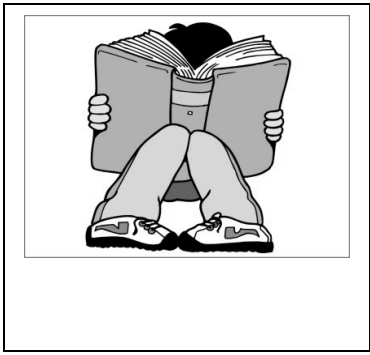

# Lecture

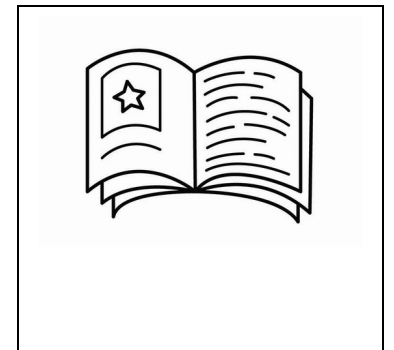
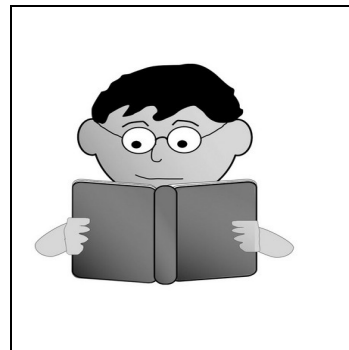
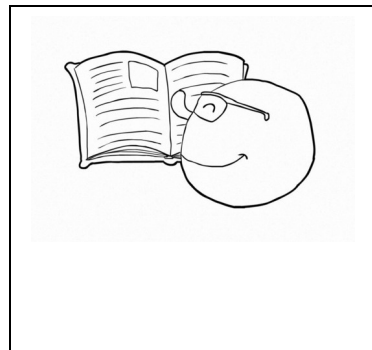

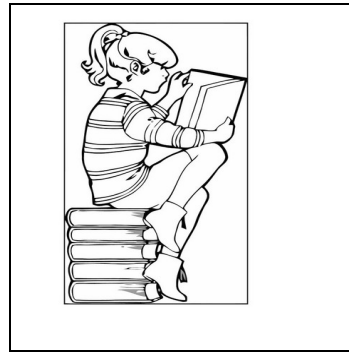
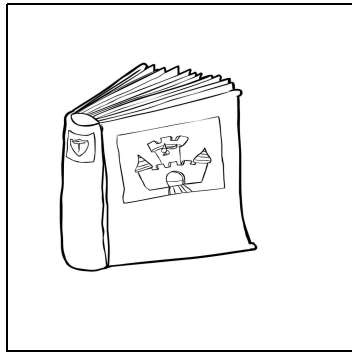
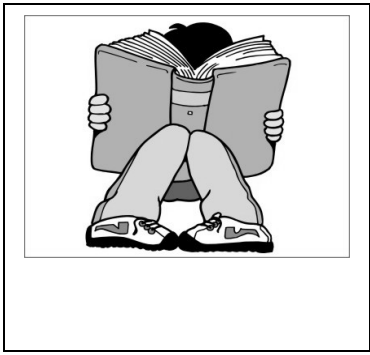

# Lecture

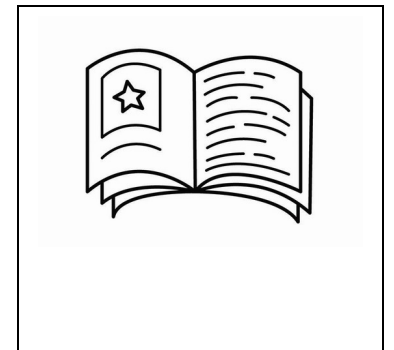
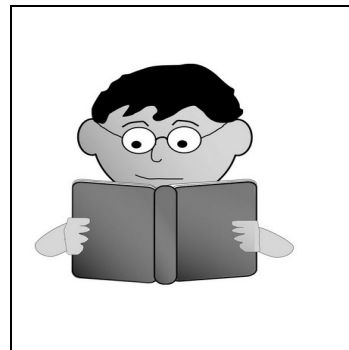
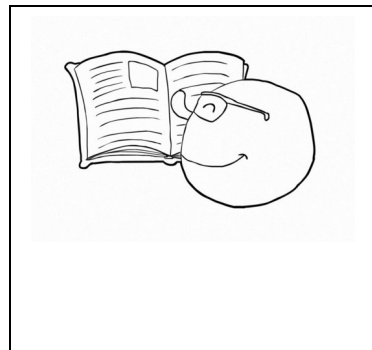

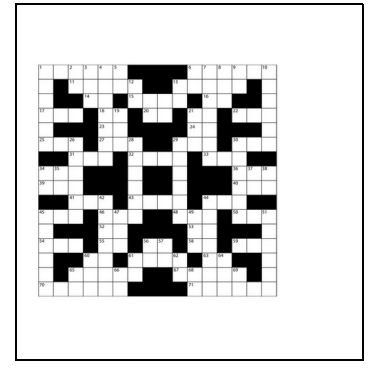
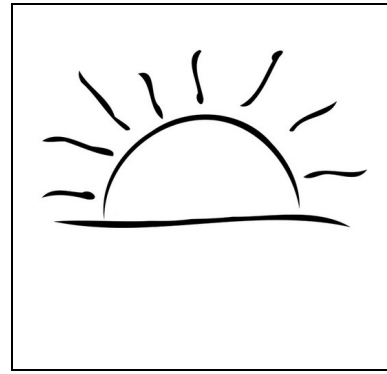
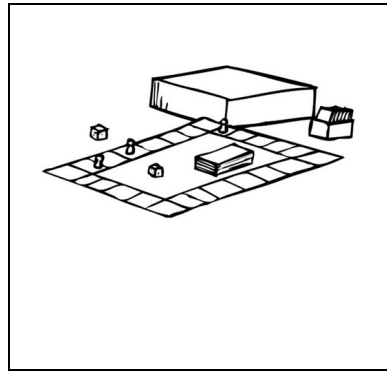
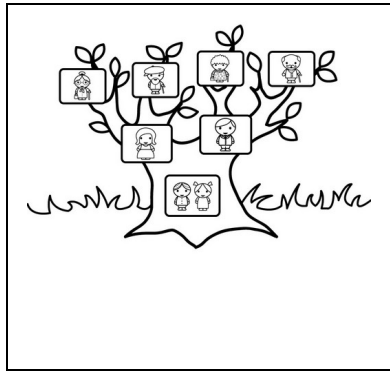
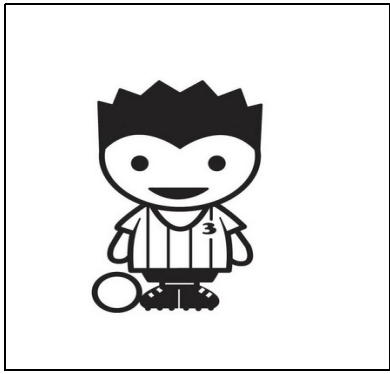

# Divers

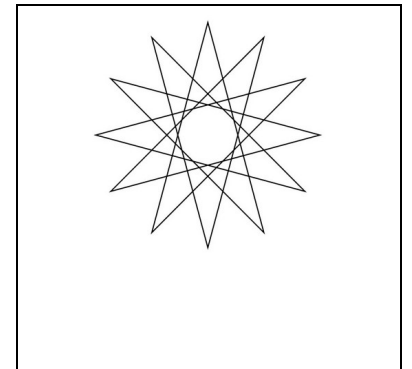
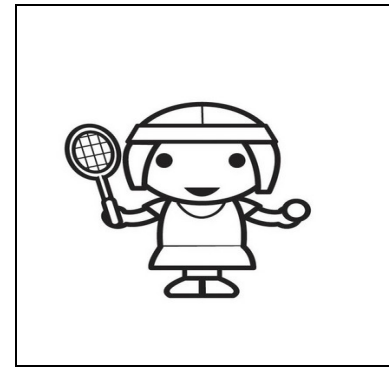
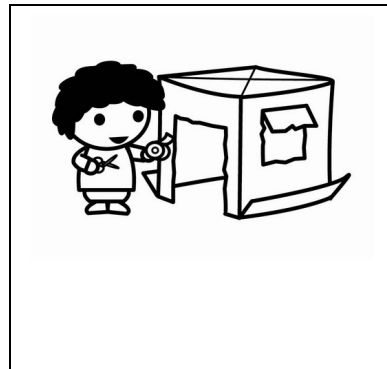
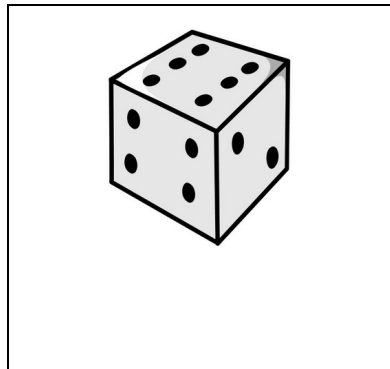
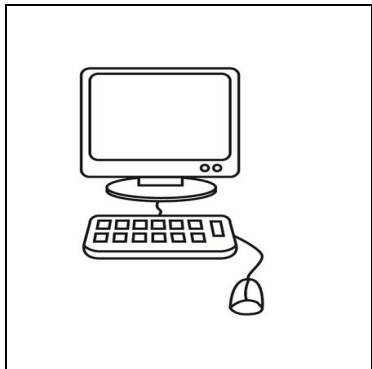

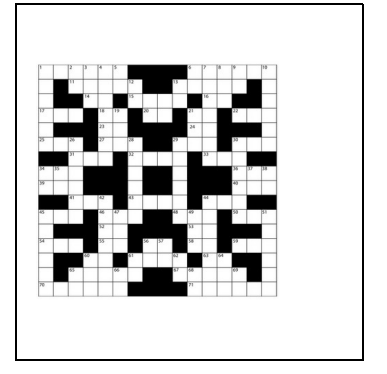
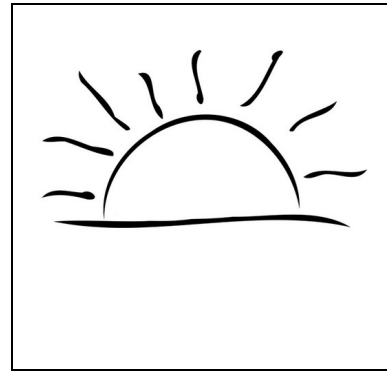
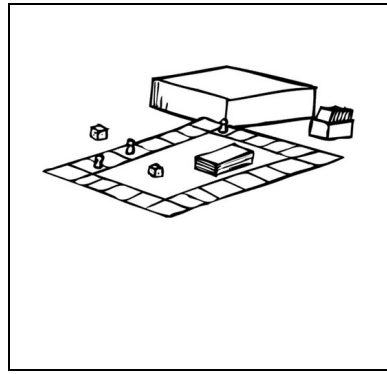
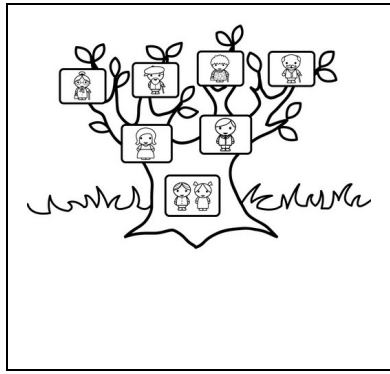
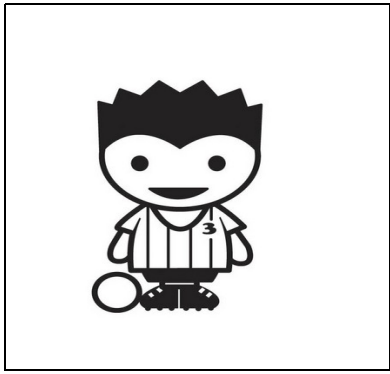

# Divers

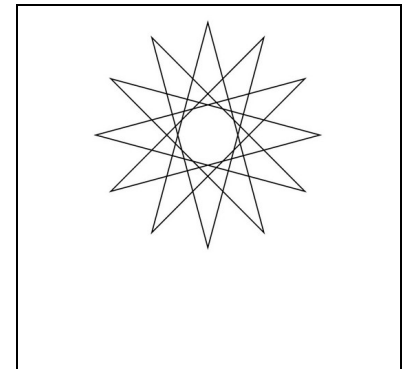
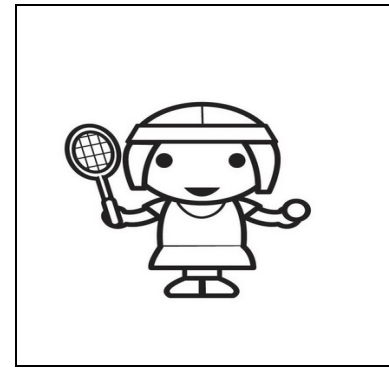
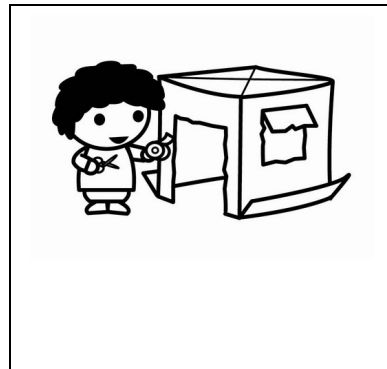
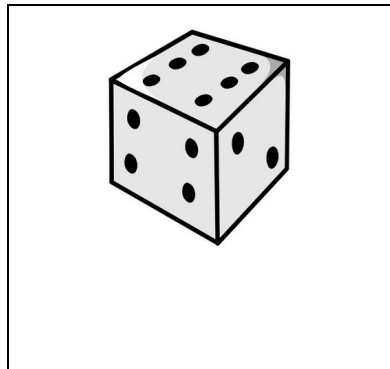
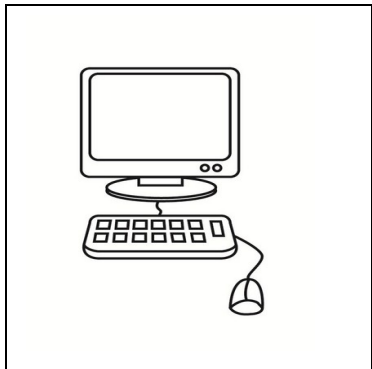

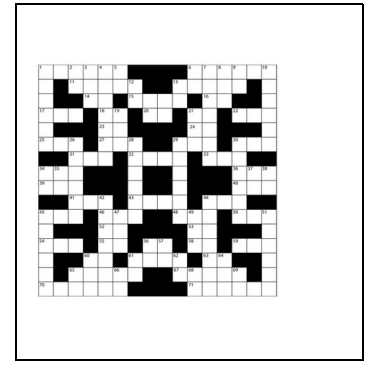
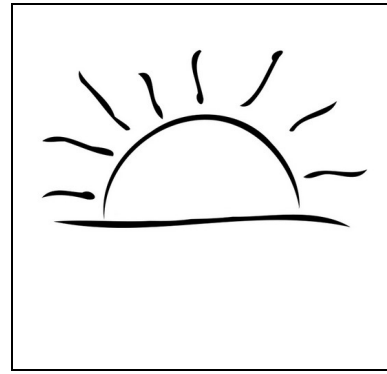
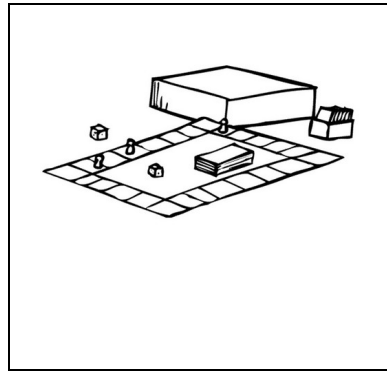
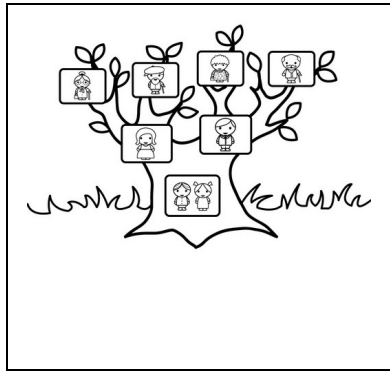
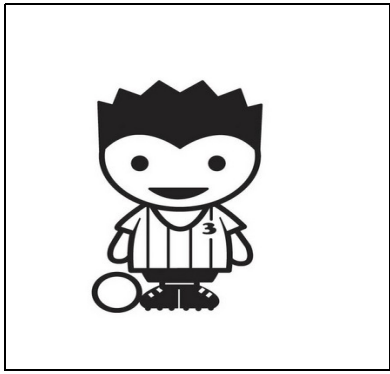

# Divers

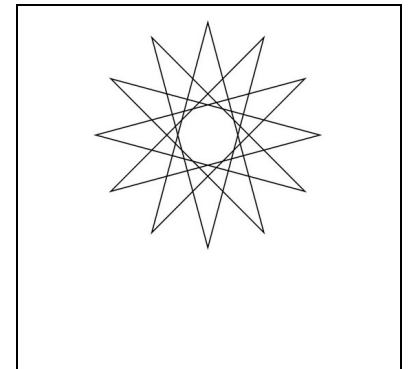
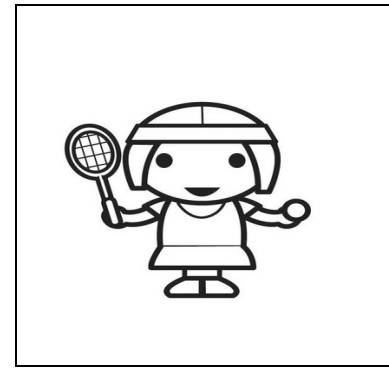
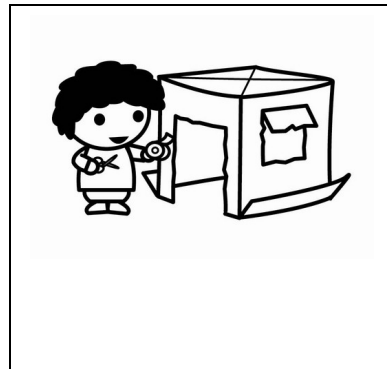
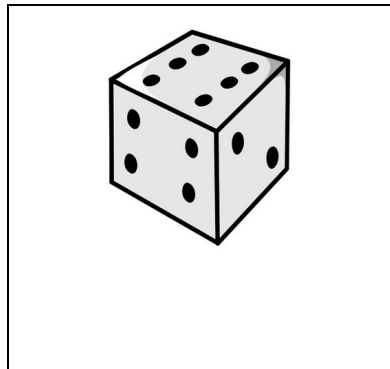
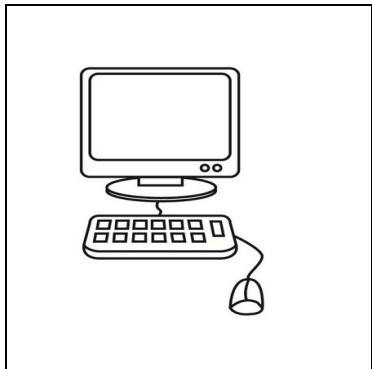

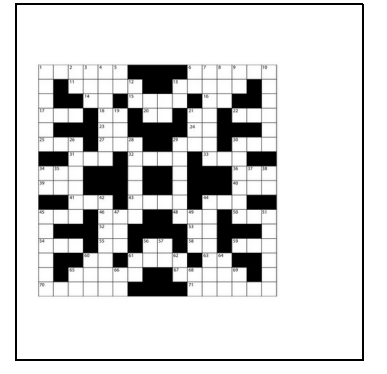
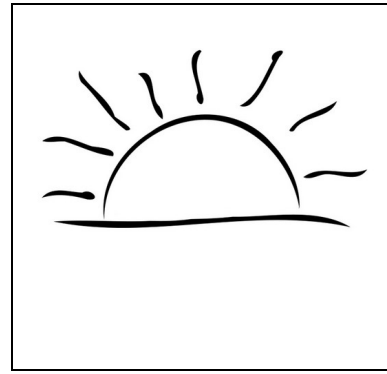
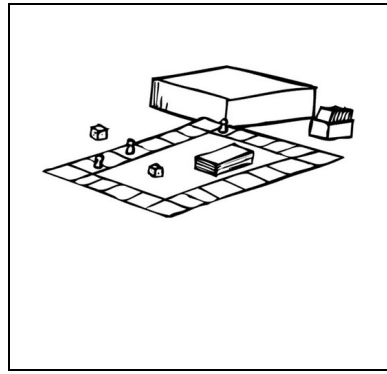
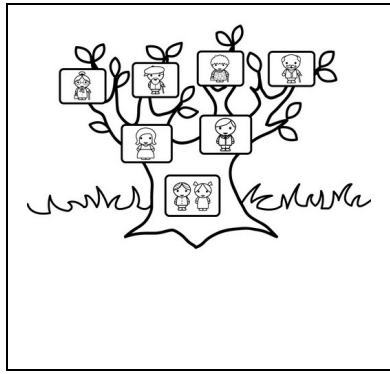
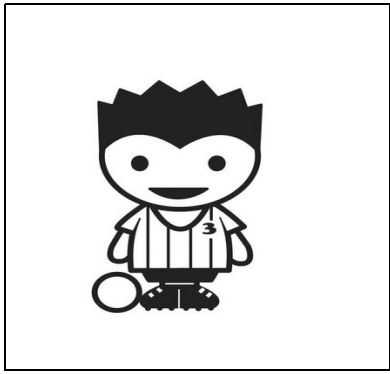

# Divers

