

Die Schulsachen

A

Avec l'aide de ton voisin, associe chaque élève avec ses affaires de classe.

D



Peter



Anita



Oliver

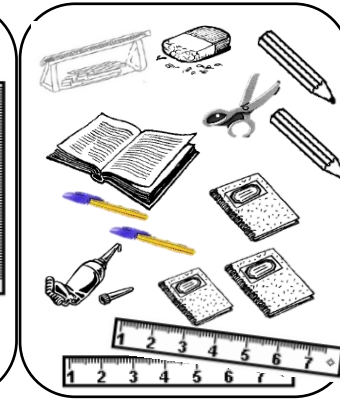
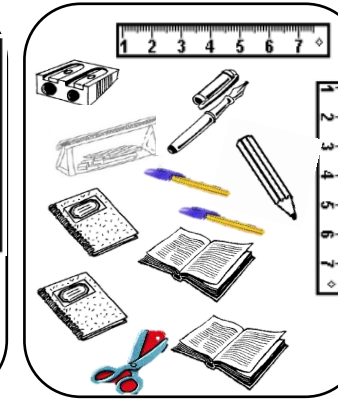
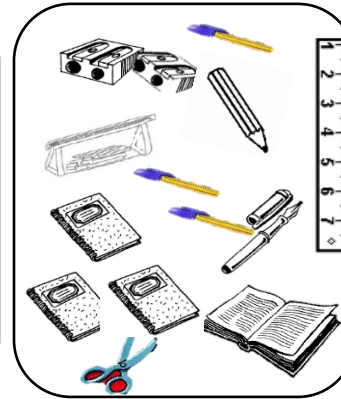
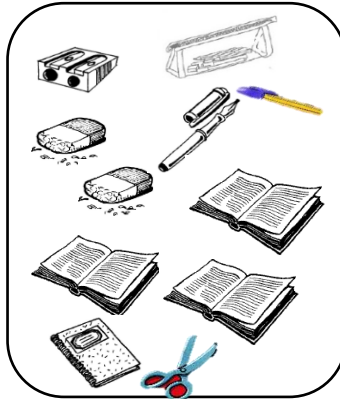
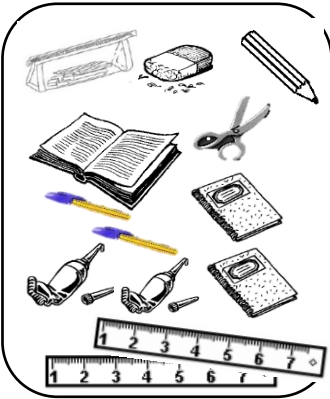
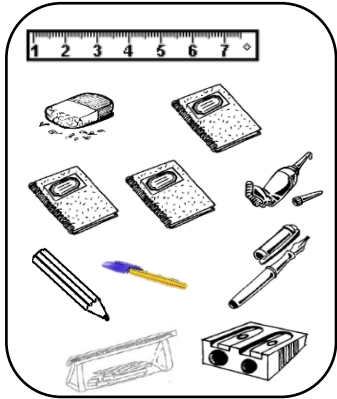

Samia

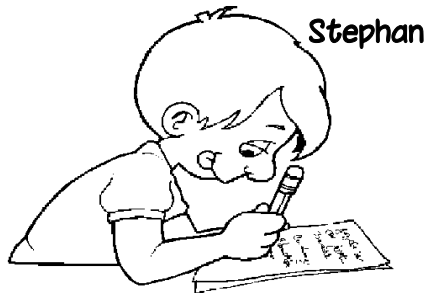

Stephan



Liv

Die Schulsachen

B

Avec l'aide de ton voisin, associe chaque élève avec ses affaires de classe.

D



Peter



Anita



Oliver

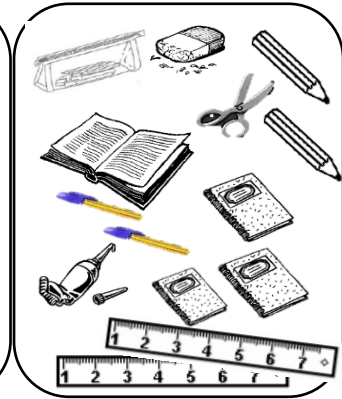
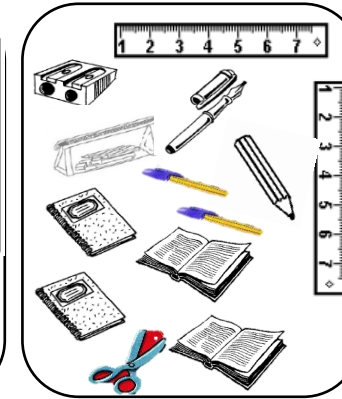
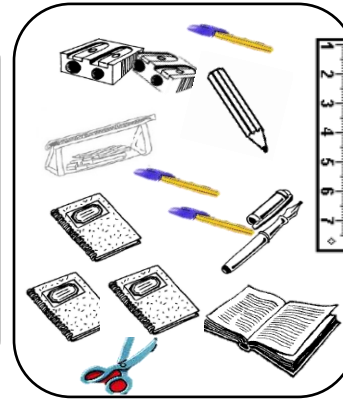
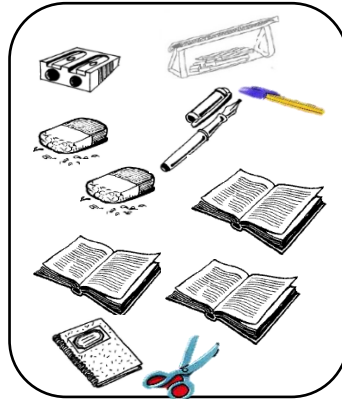
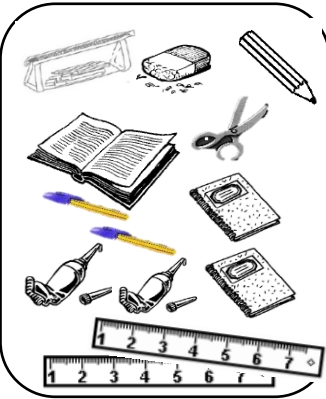
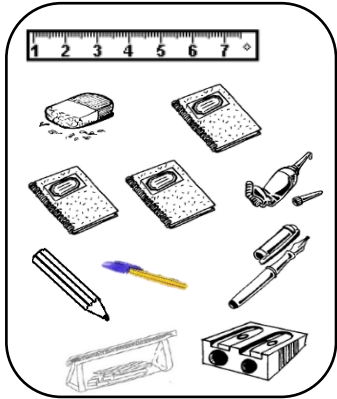

Samia

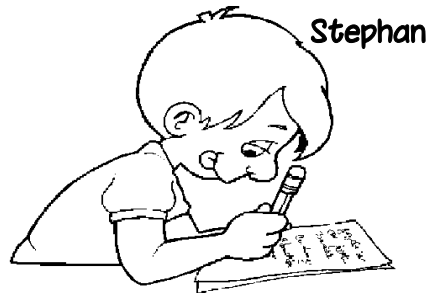

Stephan



Liv