

L'enfant jette la pomme.

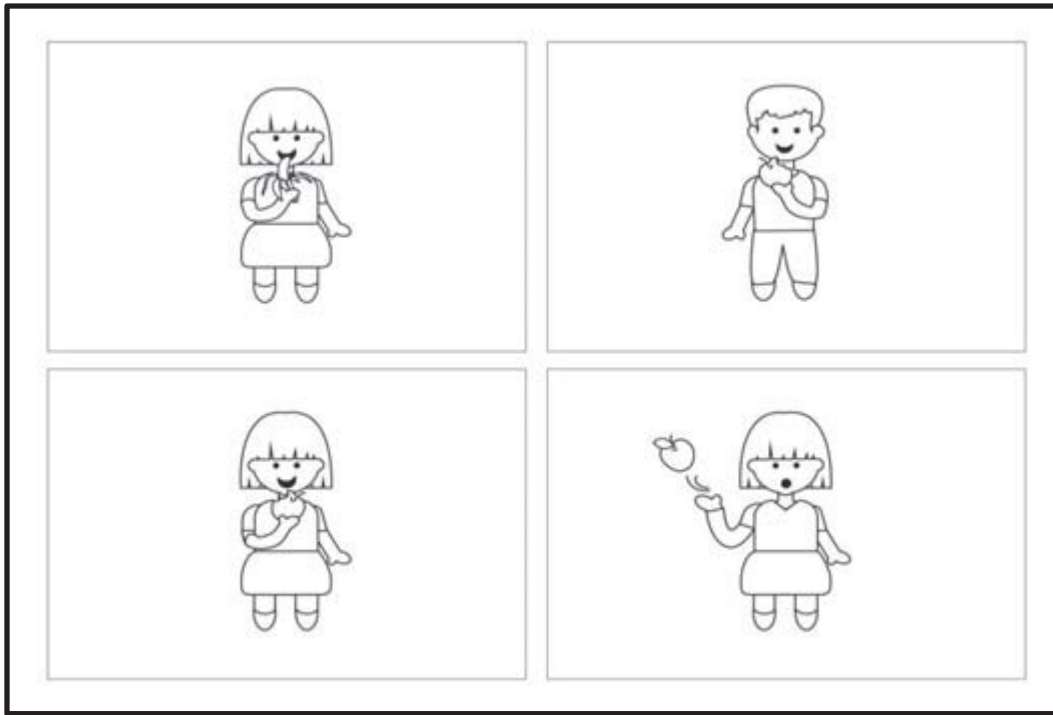

Le stylo est dans le carton.

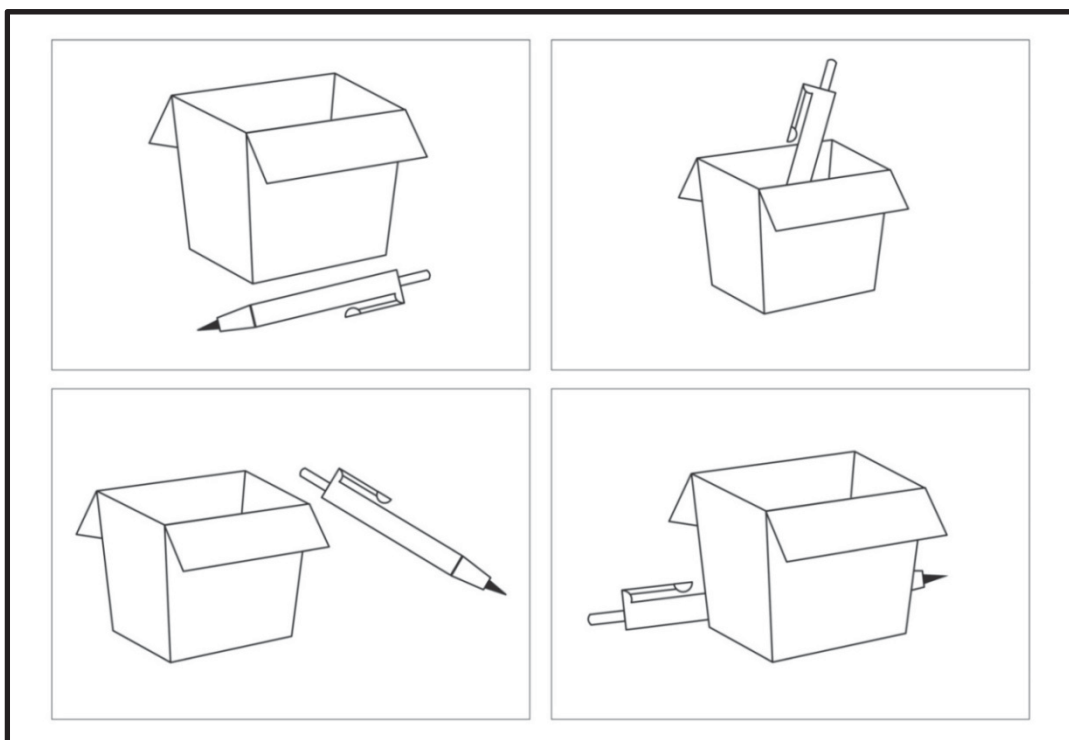

Le garçon court.

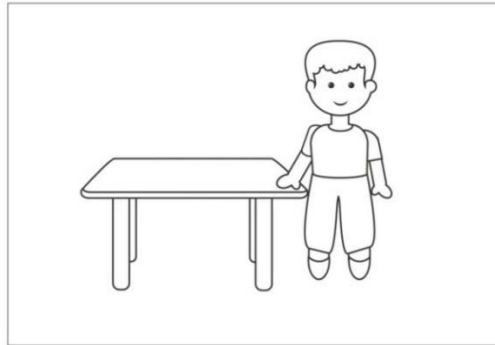
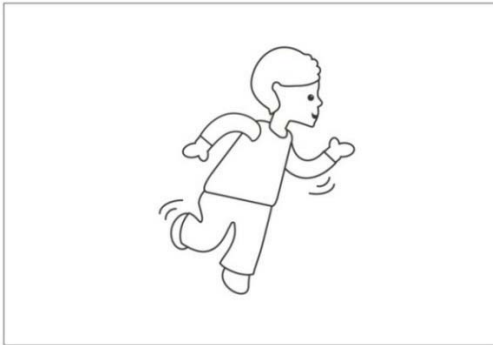
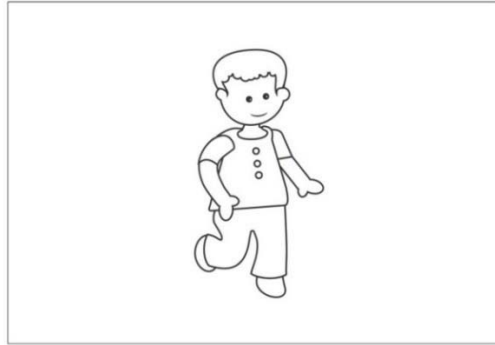
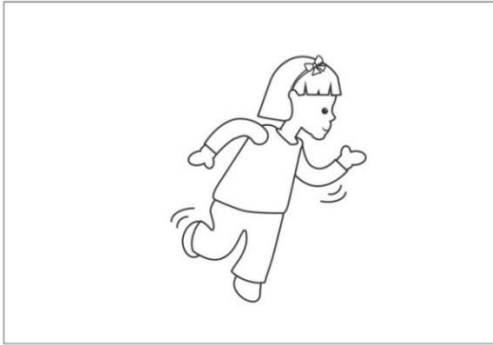

La tasse est grande.

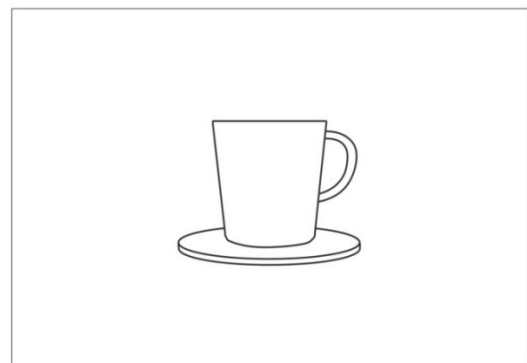

Le chien n'est pas dans la niche.

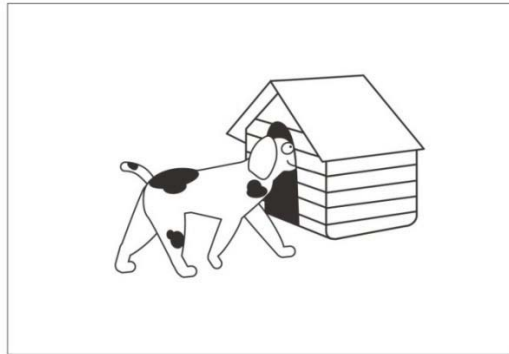
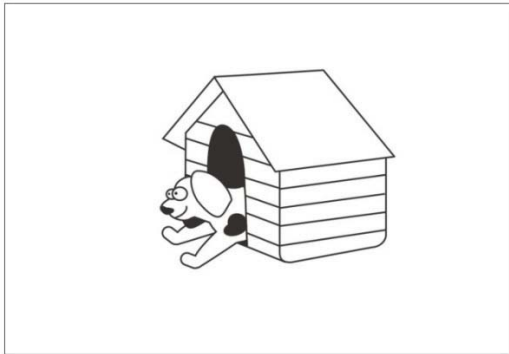
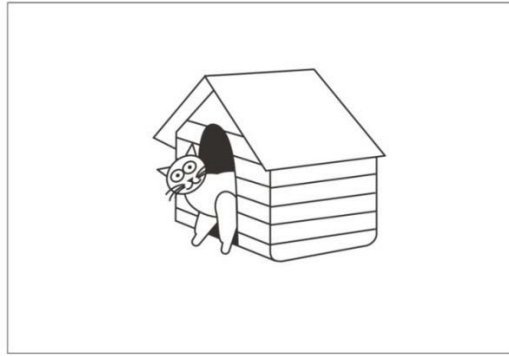
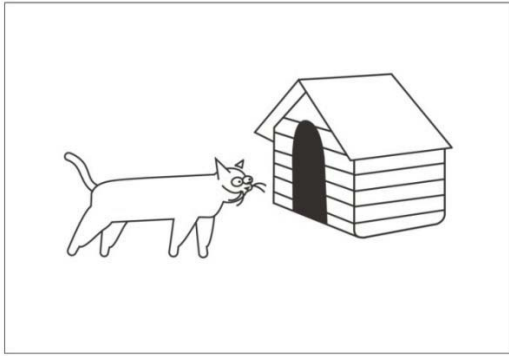

La fille ne court pas.

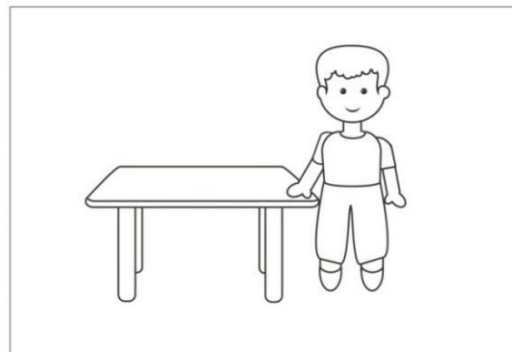
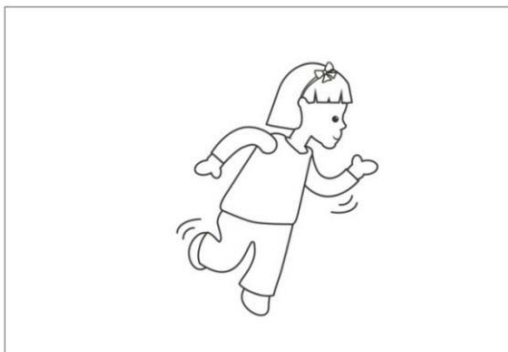
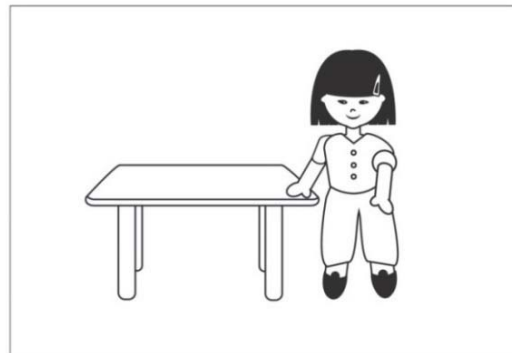

La dame les regarde.



Le garçon la porte.

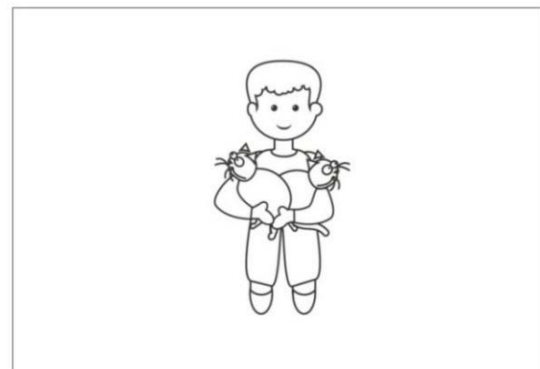
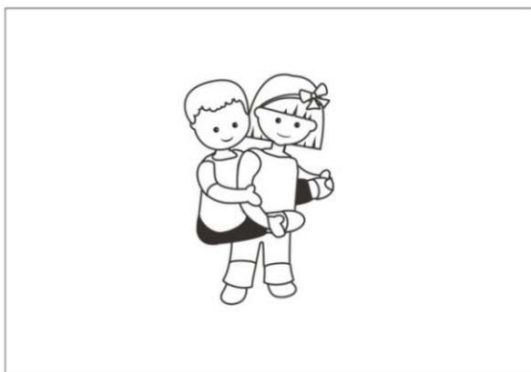

L'étoile est dans le cercle.

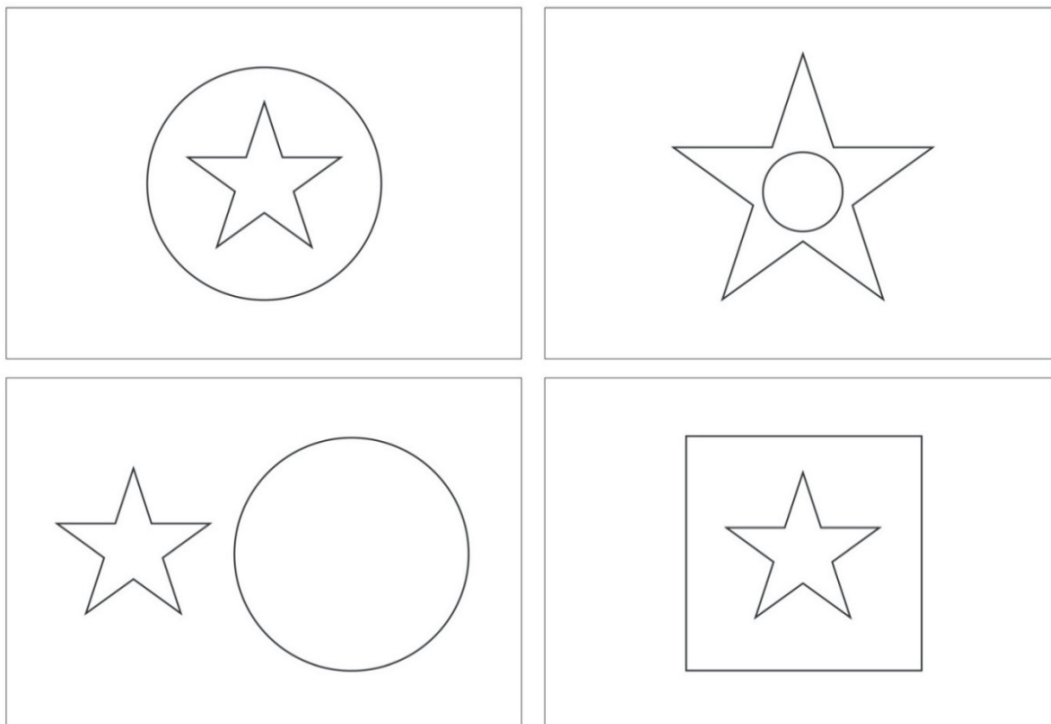

Le bol est derrière la tasse.



La tasse est devant le carton.

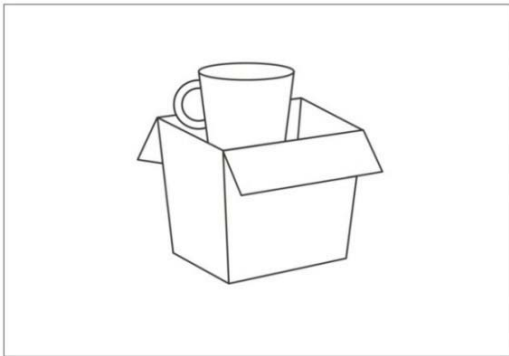
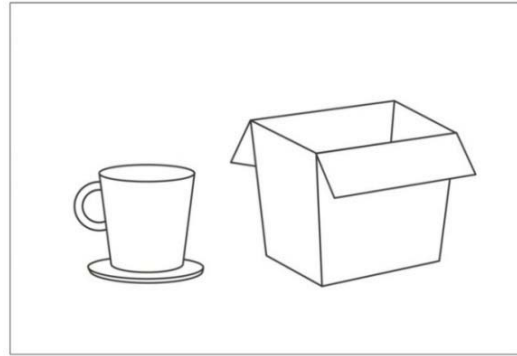
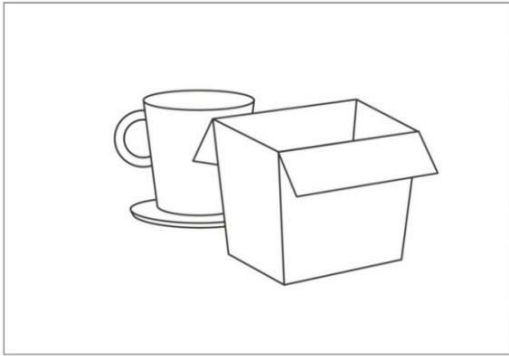

La dame marche.

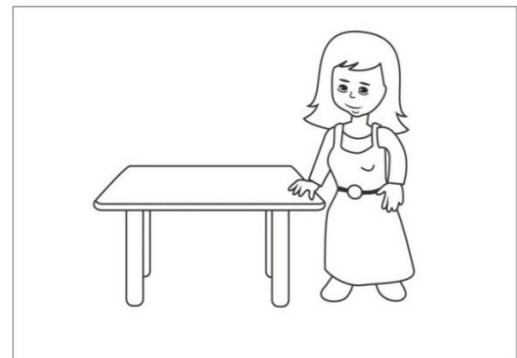
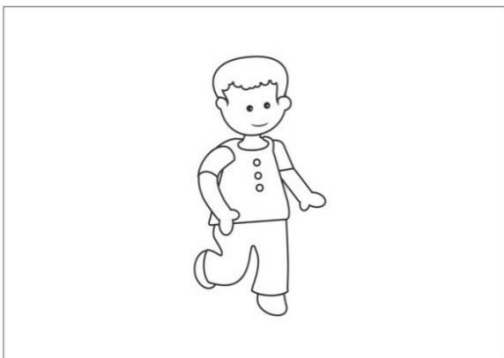
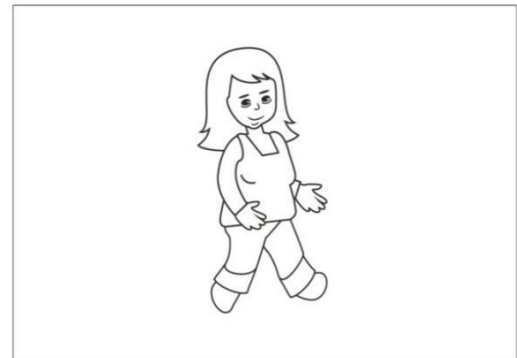

Le vélo suit la moto.

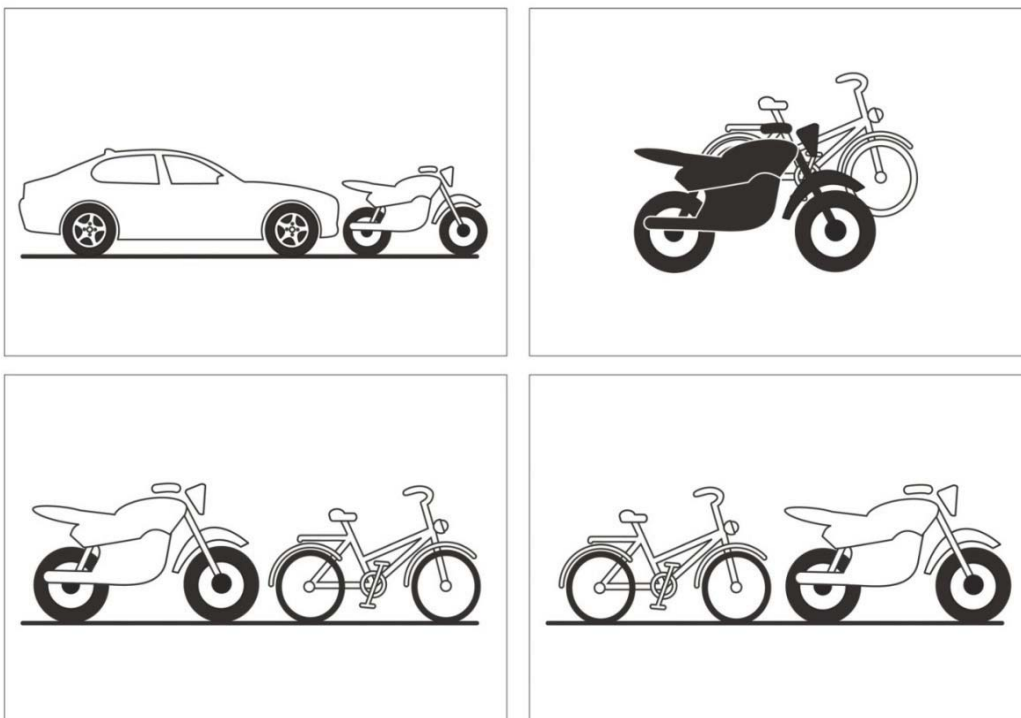

Le garçon les regarde.

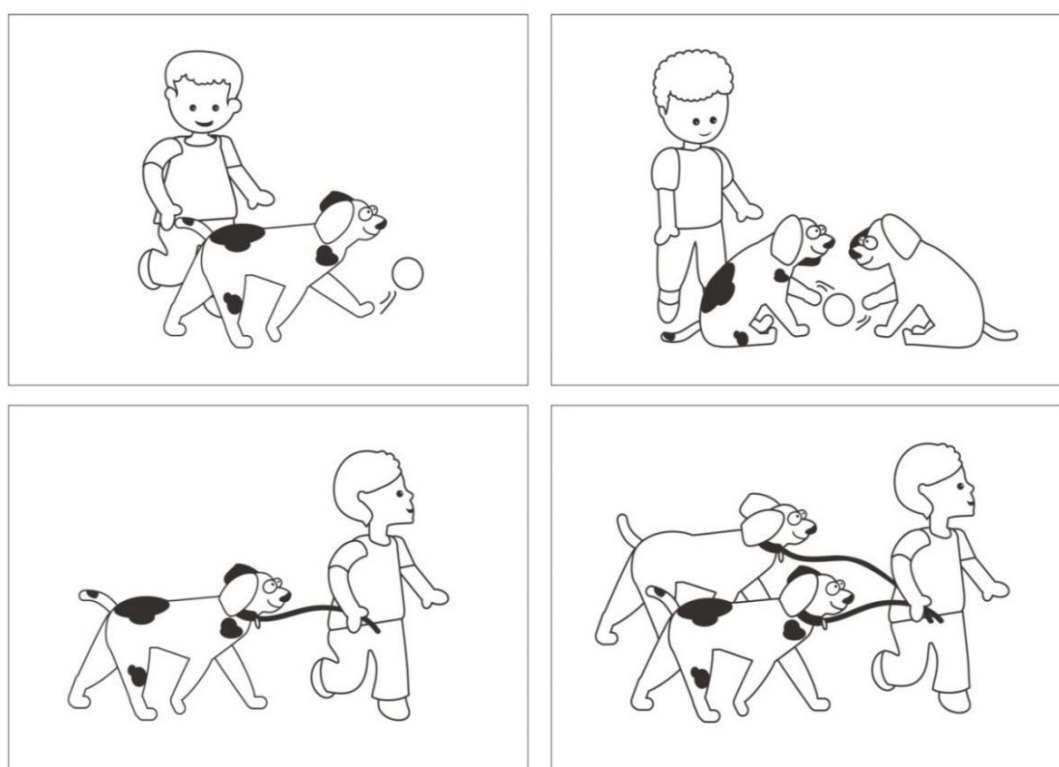

La dame le porte.

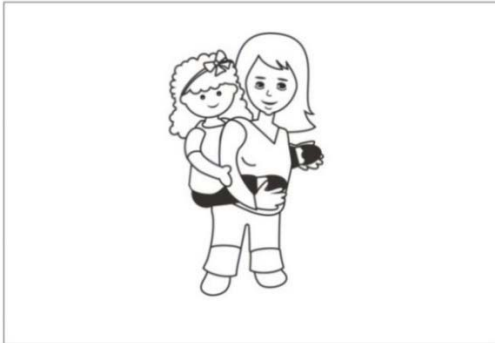
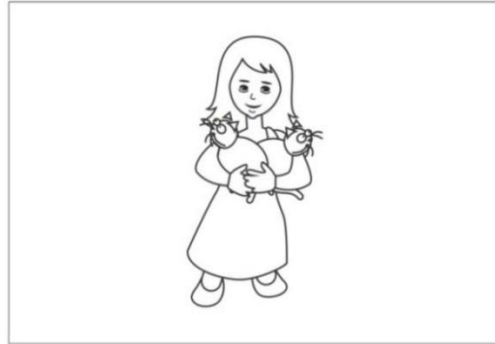
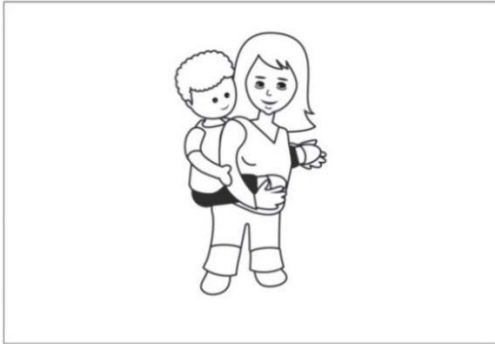

Le crayon est sur le cahier.

