

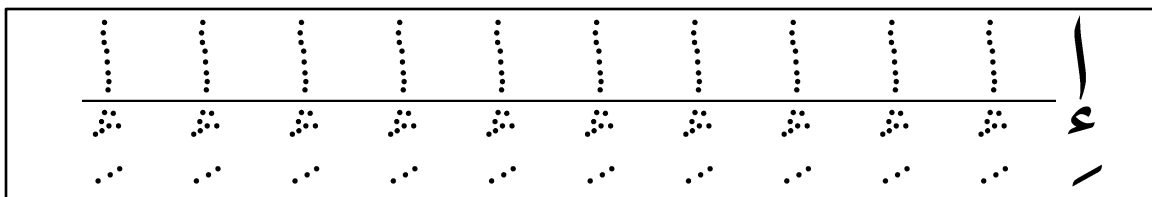

لون واكتب

الخَرَكَات

الكسرة

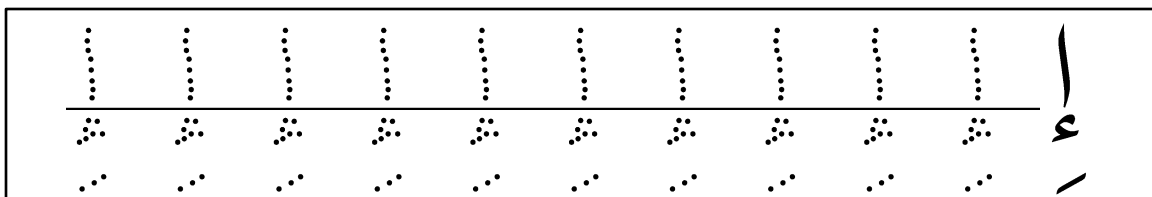
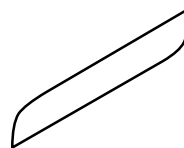

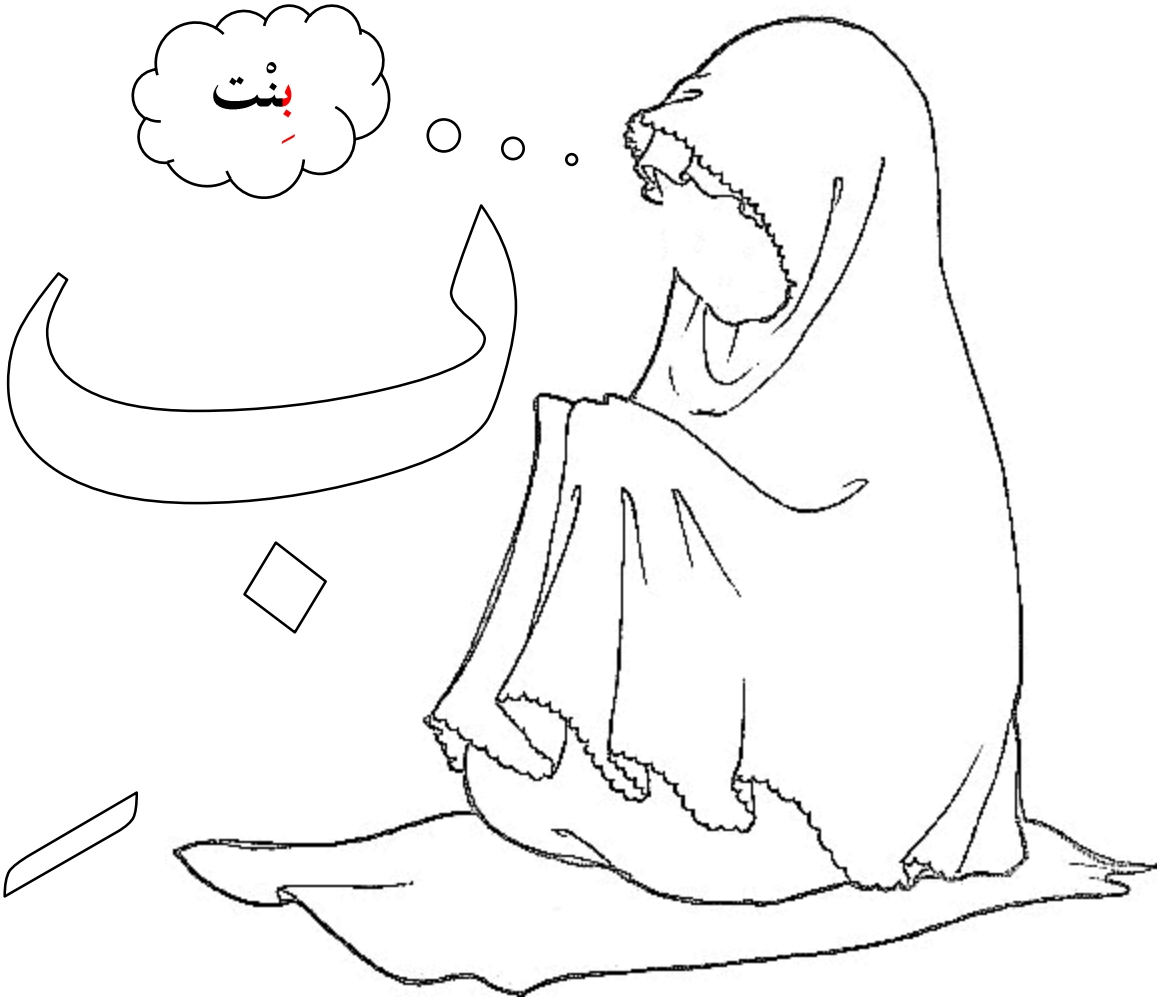

ب ب ب ب ب ب ب

ب ب ب ب ب ب ب

تمساح

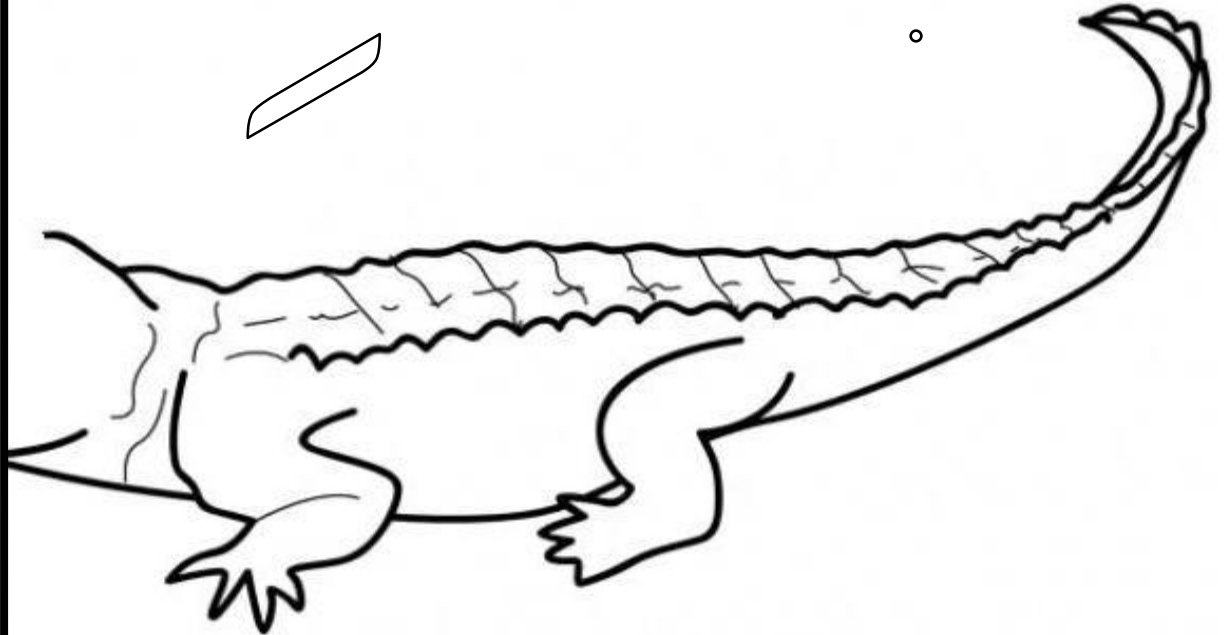
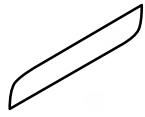
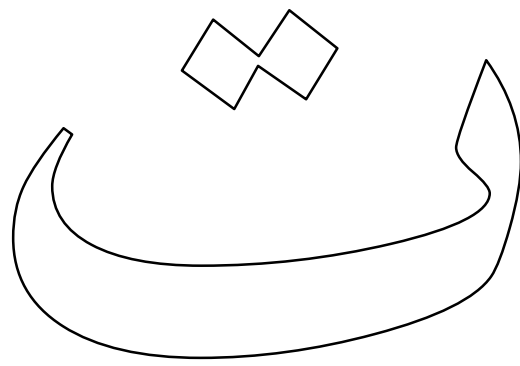

ت ت ت ت ت ت ت

ت ت ت ت ت ت ت

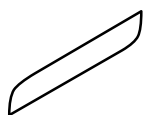
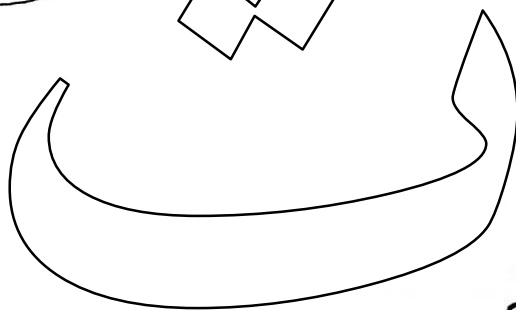

ثياب ثياب ثياب ثياب ثياب ثياب ثياب

ثياب ثياب ثياب ثياب ثياب ثياب ثياب

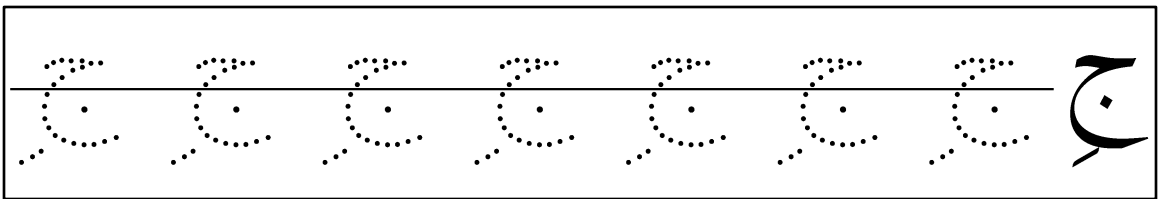
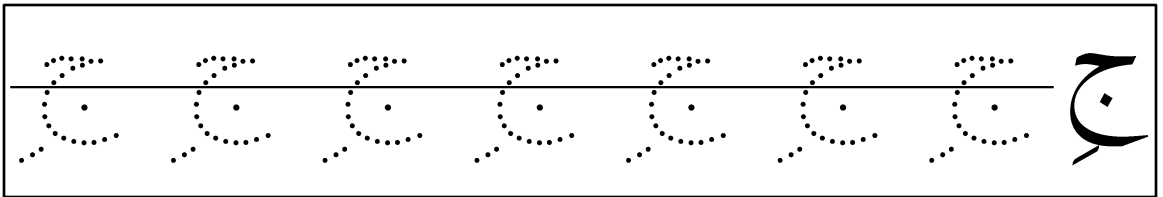
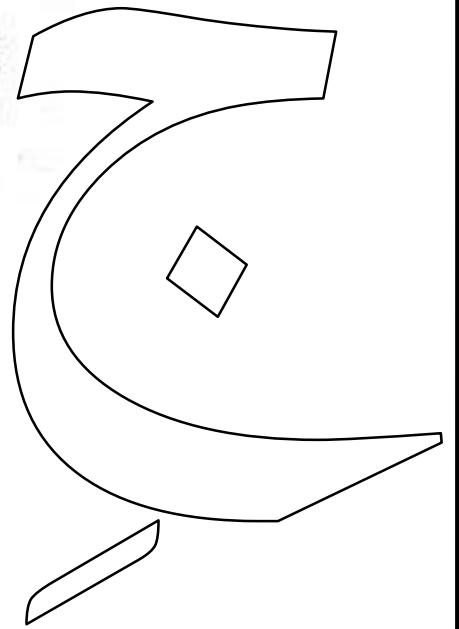
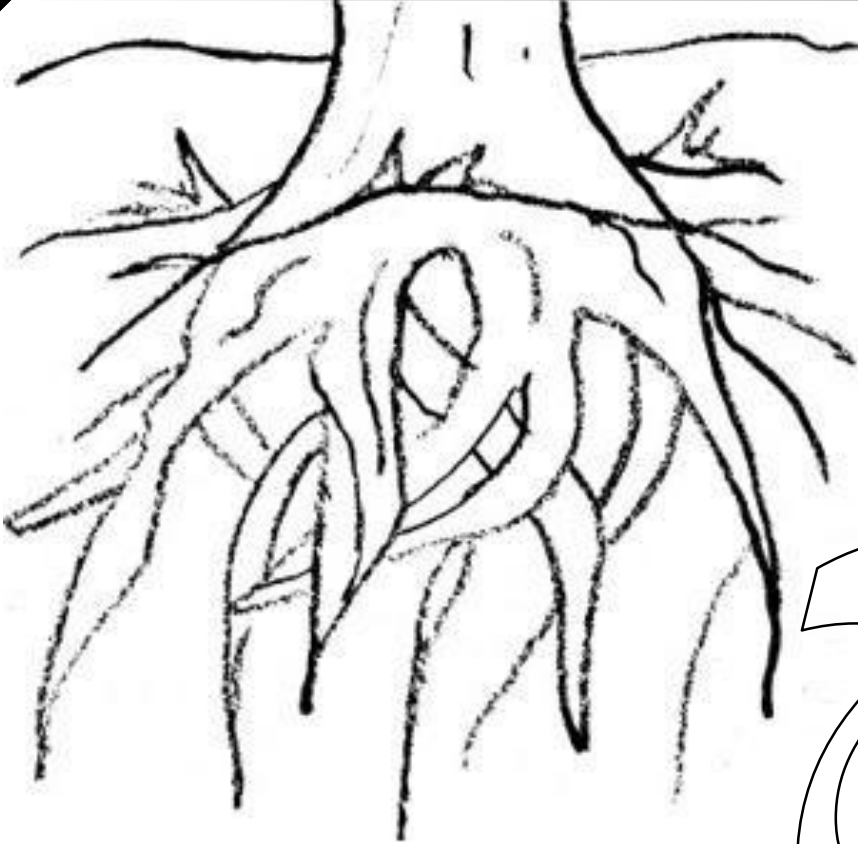

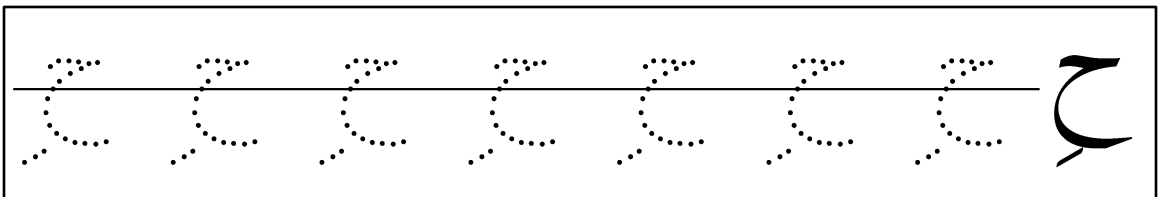
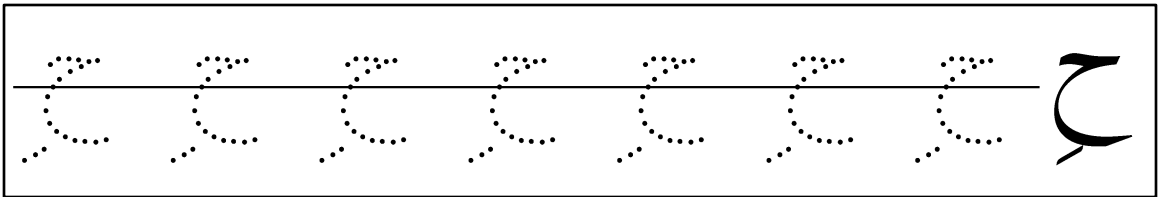
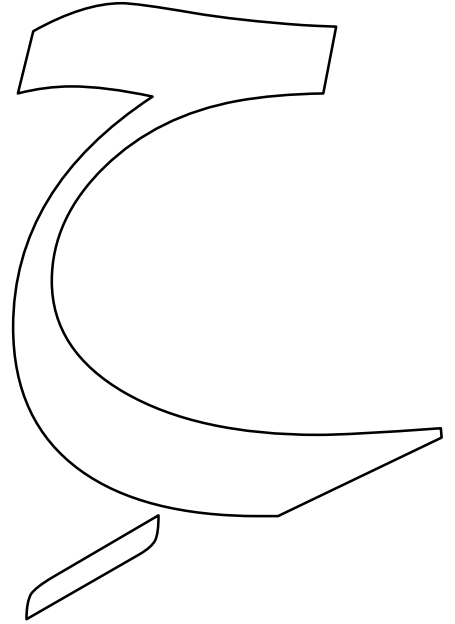

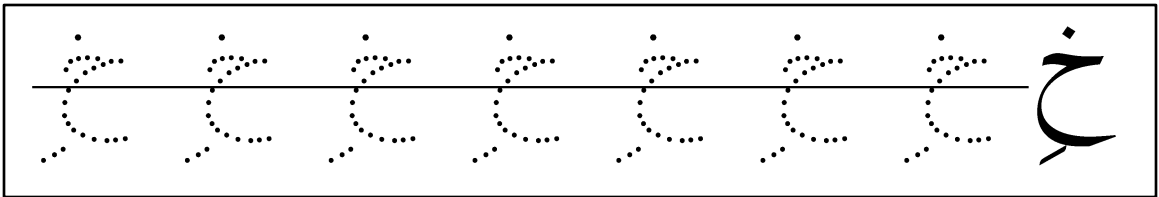
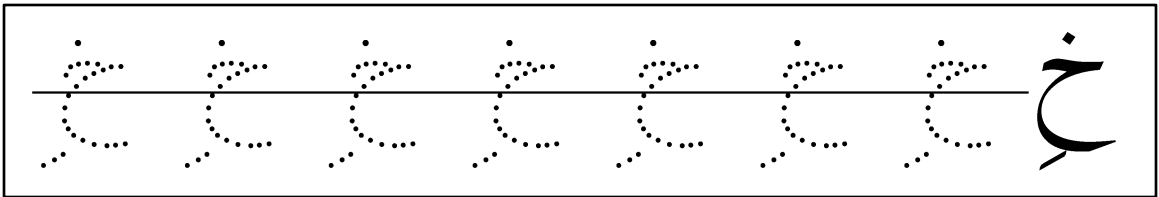
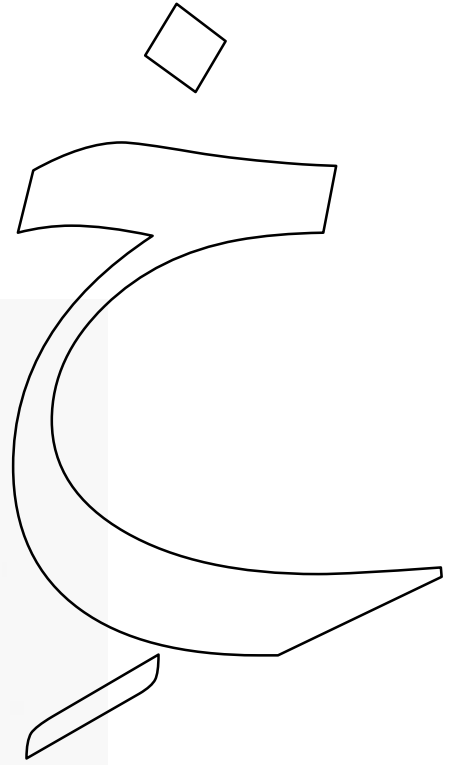
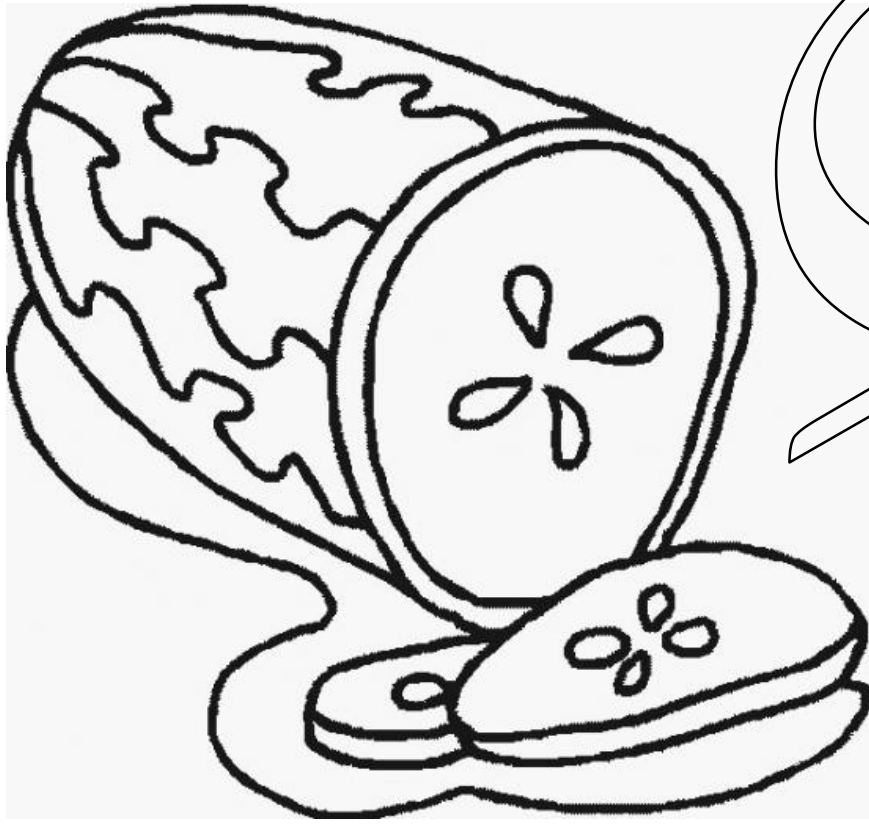



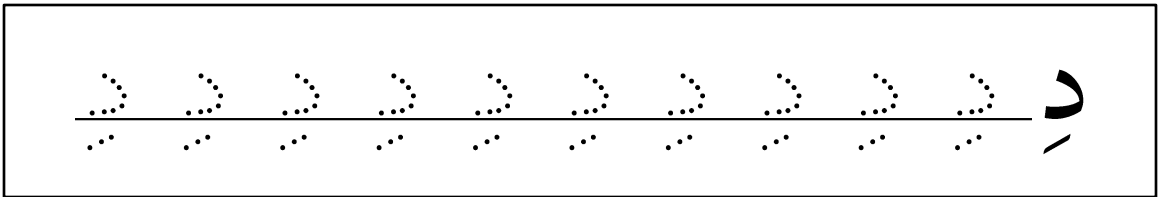
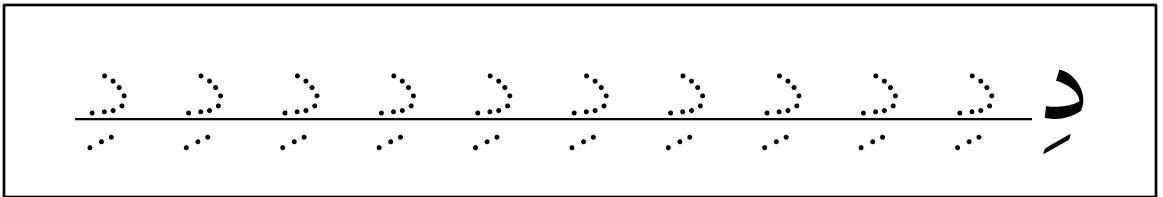
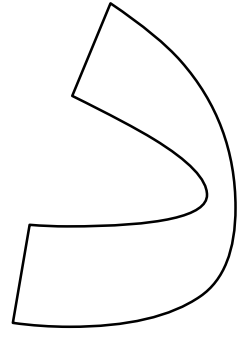

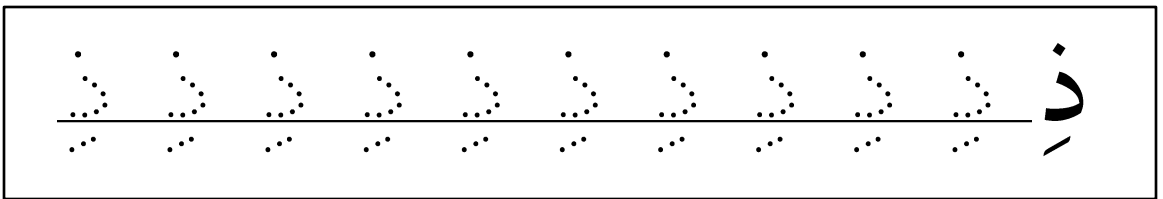
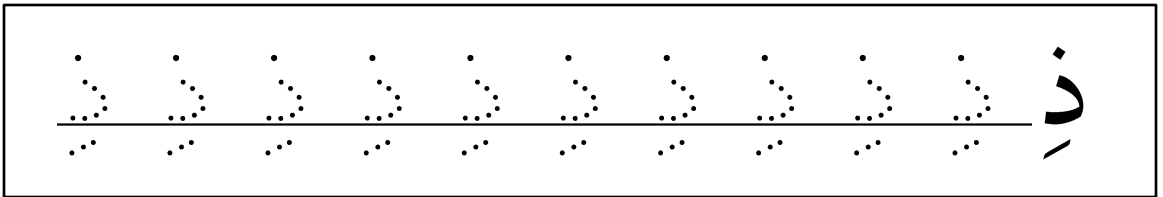
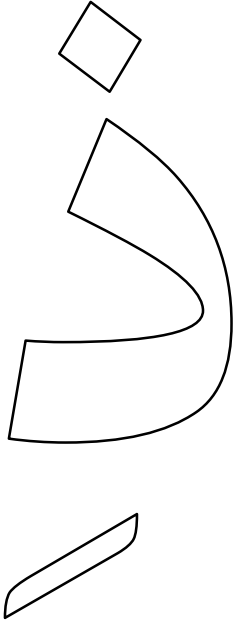

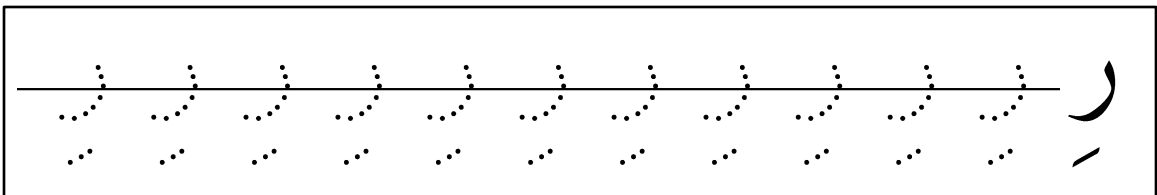
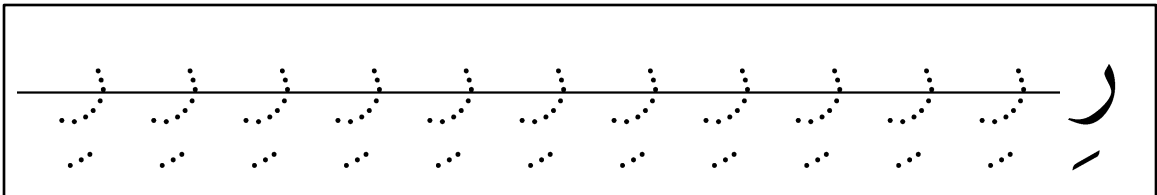
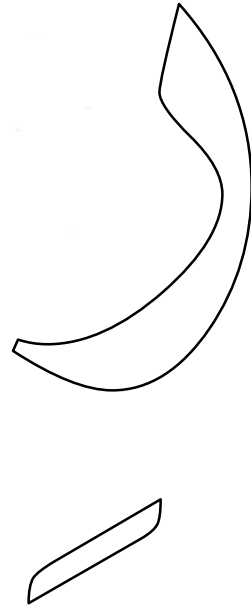

زِيَارَةُ الْمَرِيضِ



ز ز ز ز ز ز ز ز ز ز

ز ز ز ز ز ز ز ز ز ز

6

س

س

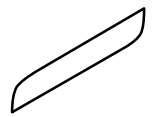

س س س س س س س

س س س س س س س

شِتَاء

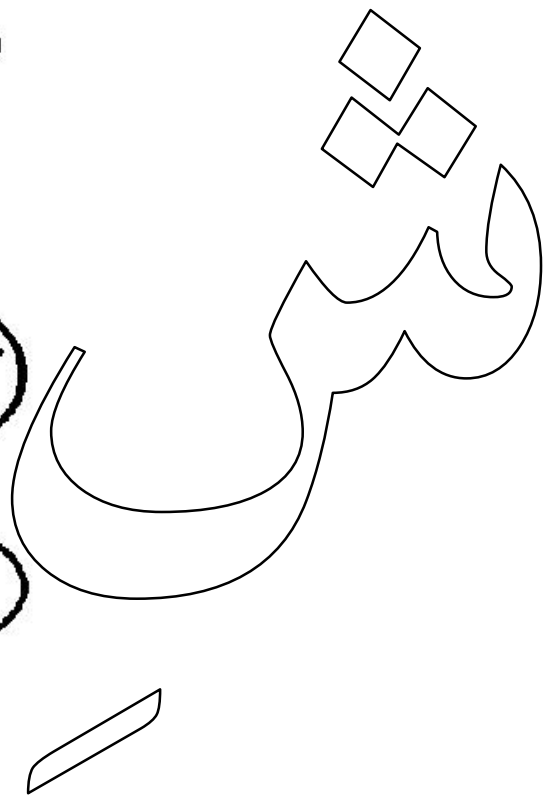

شِ شِ شِ شِ شِ شِ شِ

شِ شِ شِ شِ شِ شِ شِ

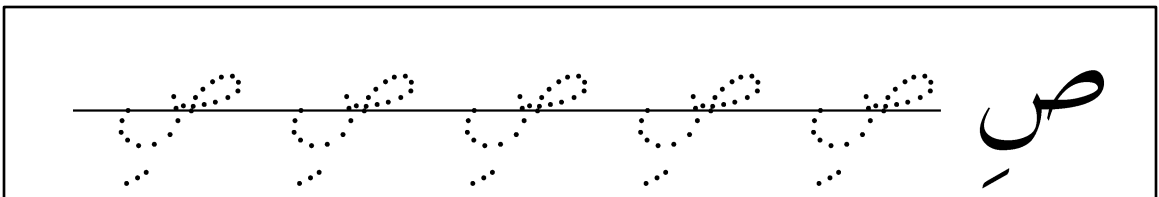
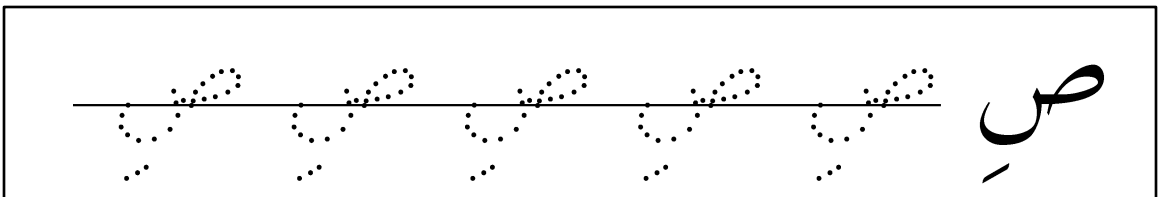
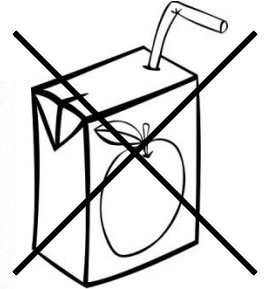
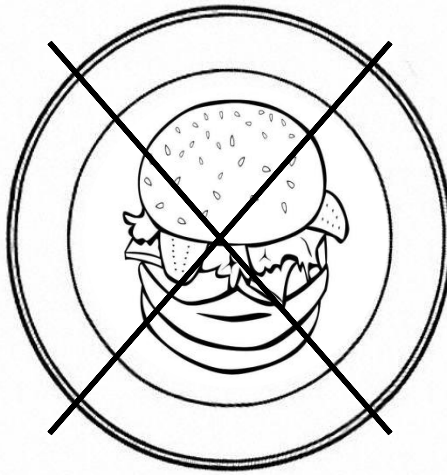
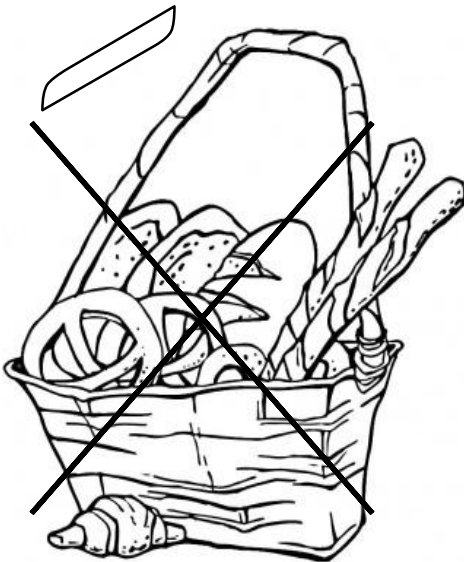
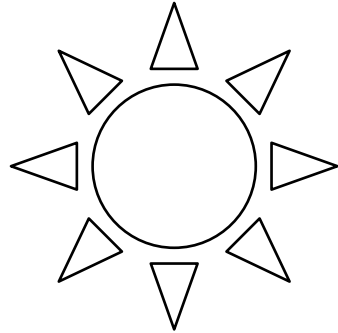
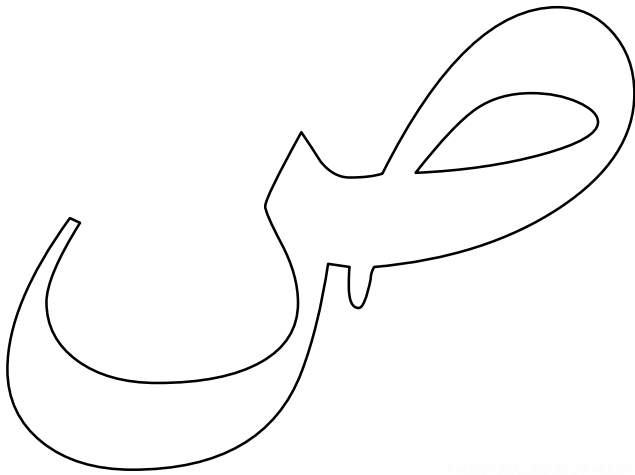



ضرب

ض

ض ض ض ض ض

ض

ض ض ض ض ض

ض



ط

ط

طفل



ط ط ط ط ط ط ط ط ط ط

ط ط ط ط ط ط ط ط ط ط

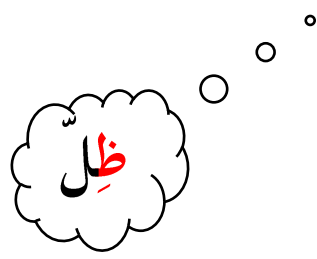
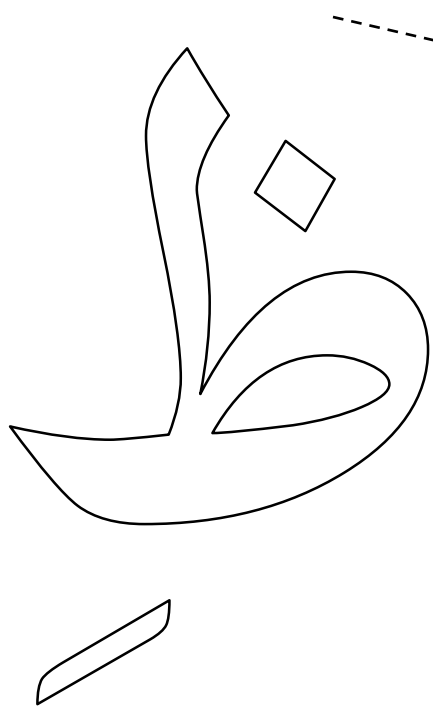

ظ ظ ظ ظ ظ ظ ظ ظ ظ

ظ ظ ظ ظ ظ ظ ظ ظ ظ

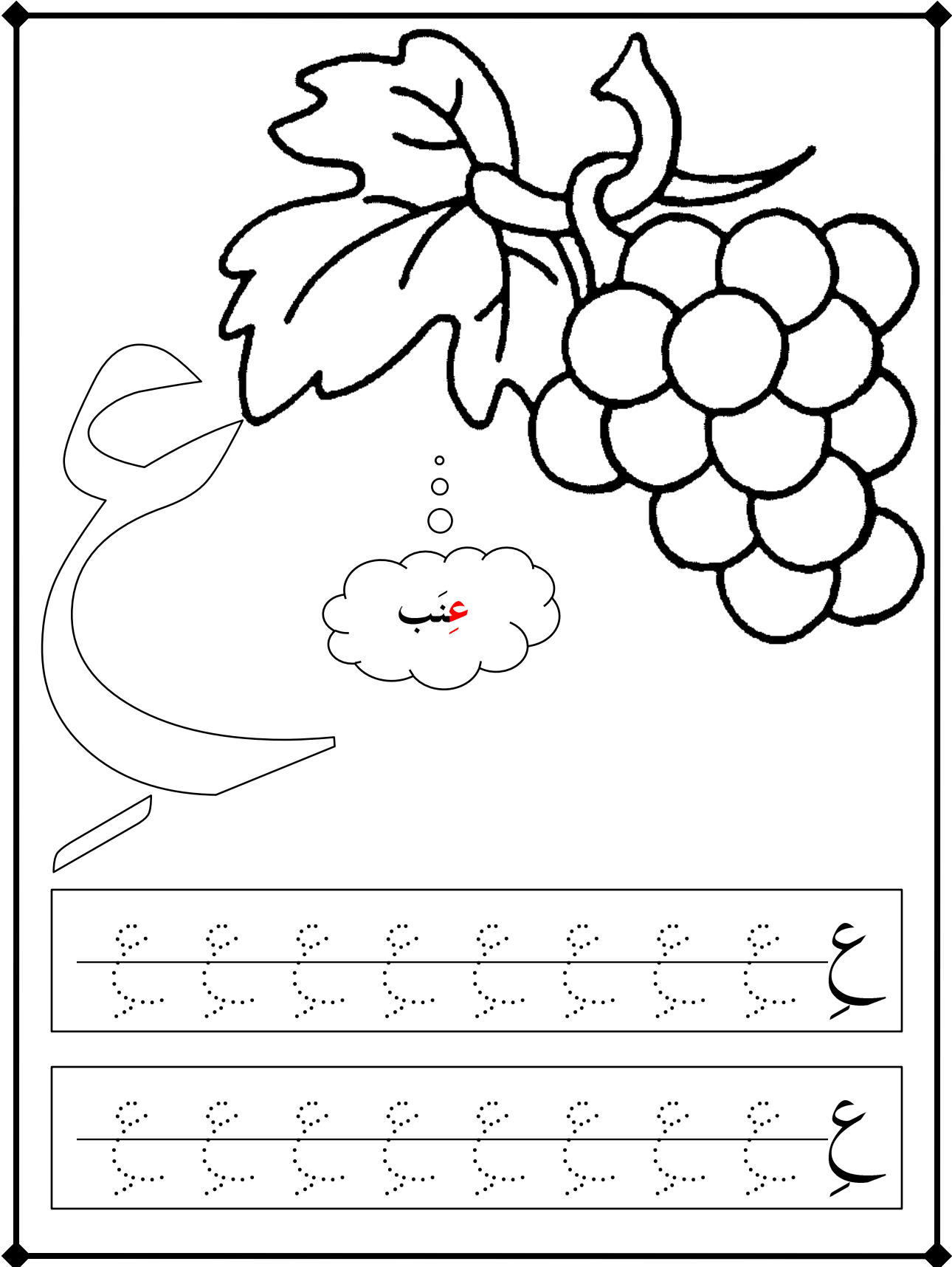

عنب

عنب عنب عنب عنب عنب عنب عنب عنب

عنب عنب عنب عنب عنب عنب عنب عنب

غلاف

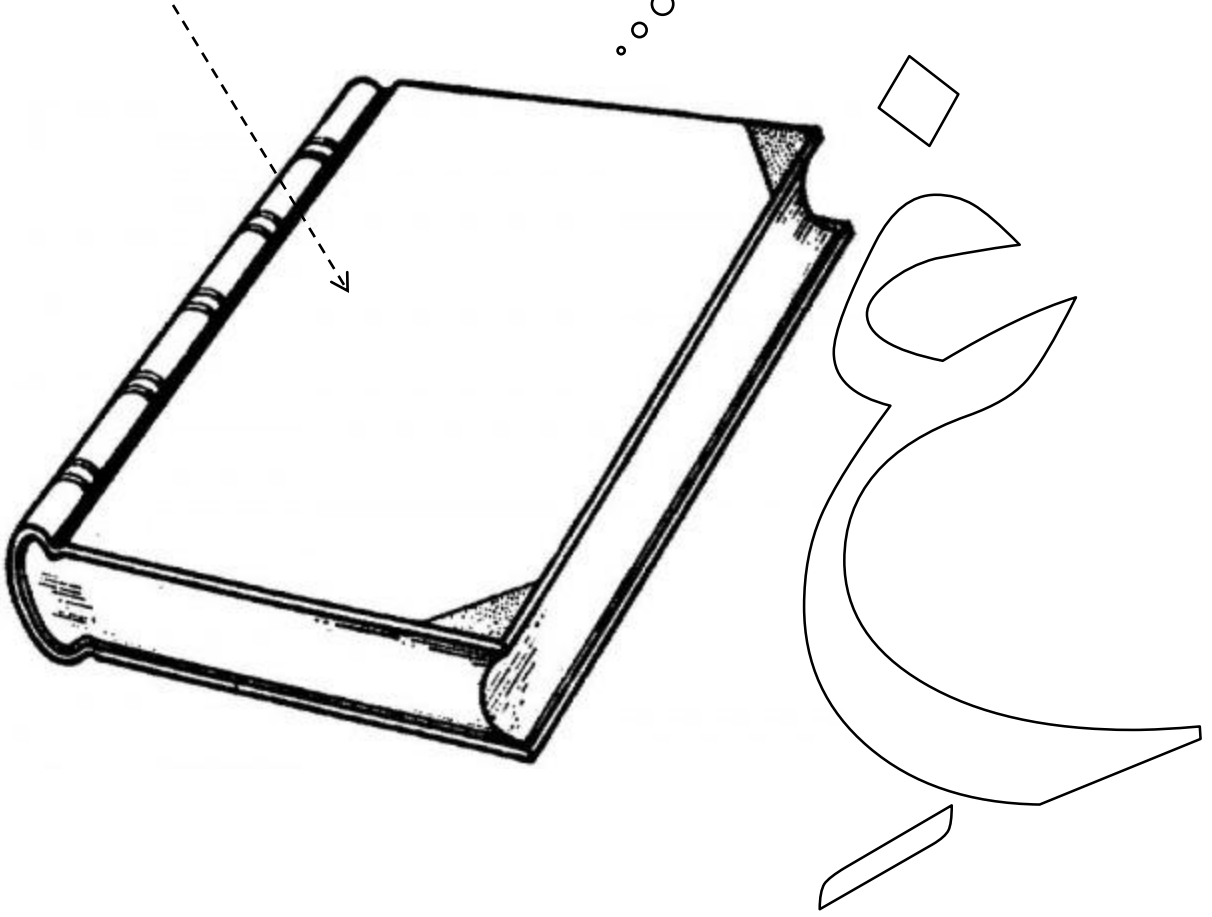

غلاف غلاف غلاف غلاف غلاف غلاف غلاف غلاف

غلاف غلاف غلاف غلاف غلاف غلاف غلاف غلاف

؟ الله أين

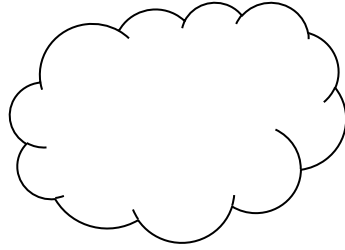
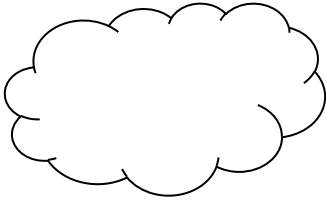

في السماء

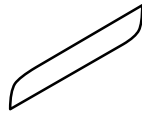
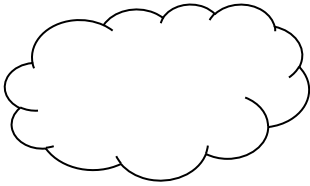
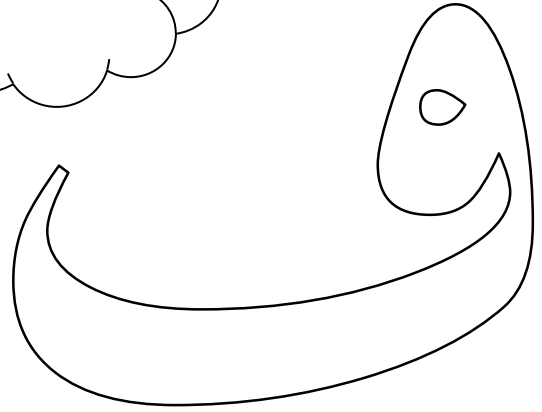

فِ فِ فِ فِ فِ فِ فِ

فِ فِ فِ فِ فِ فِ فِ



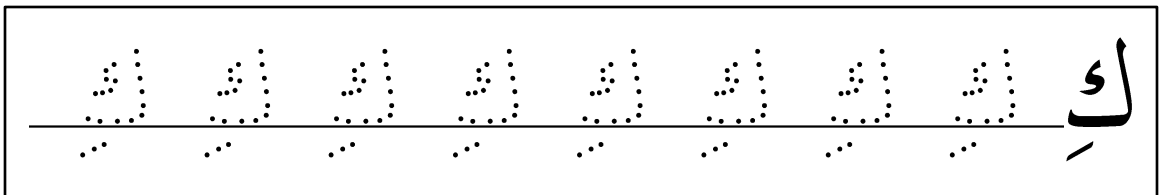
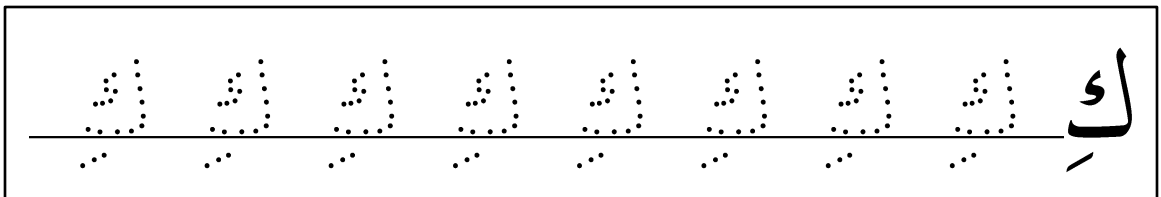
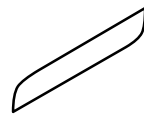
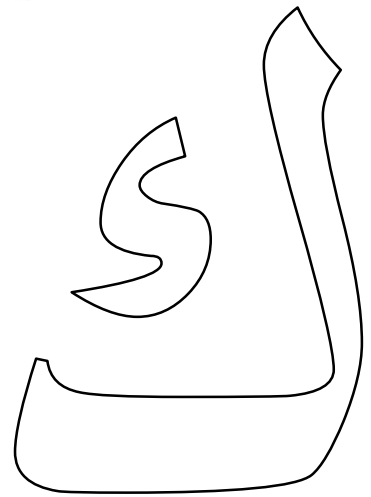
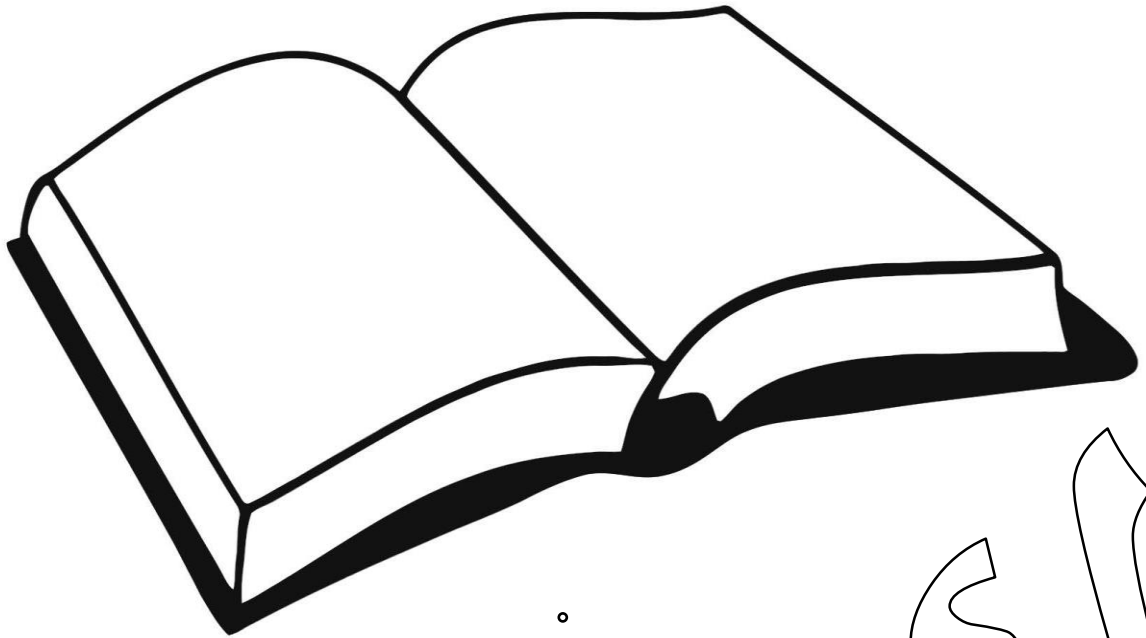

لسان

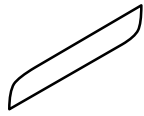
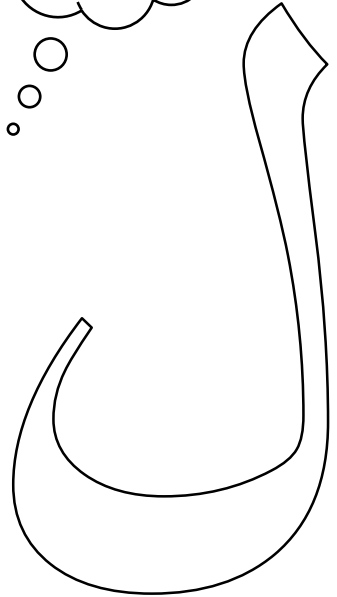
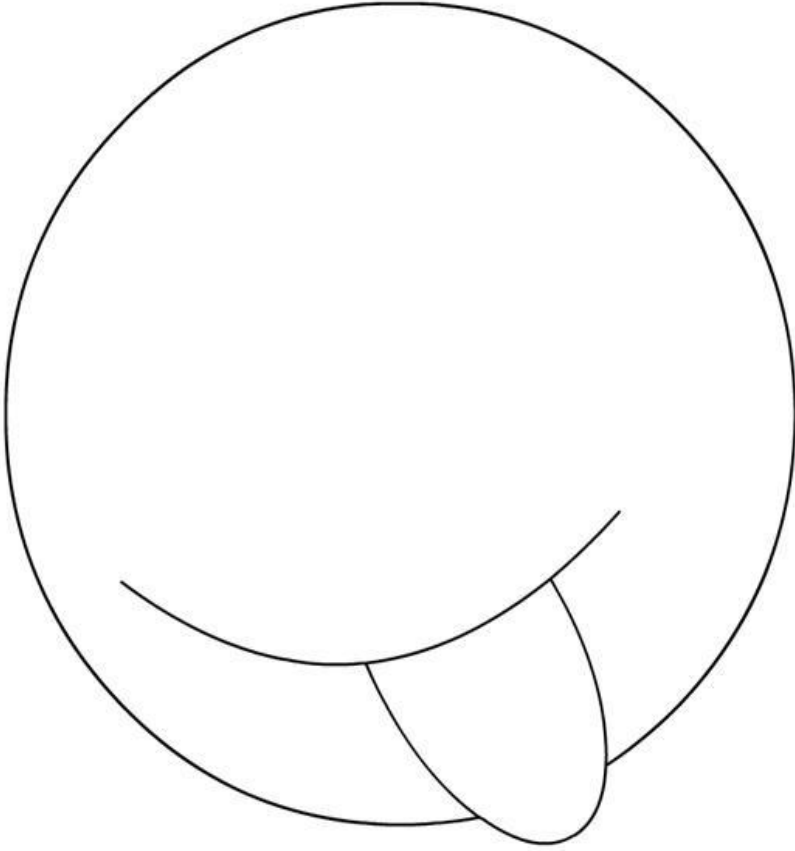

Tracing practice row 1: A series of dotted Arabic letter 'L' (ل) on a horizontal line, followed by a solid 'L' with a red dot and a red stroke indicating the writing direction.

Tracing practice row 2: A second series of dotted Arabic letter 'L' (ل) on a horizontal line, followed by a solid 'L' with a red dot and a red stroke indicating the writing direction.



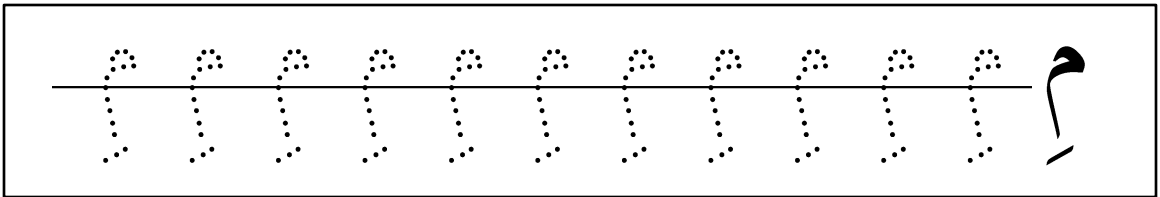
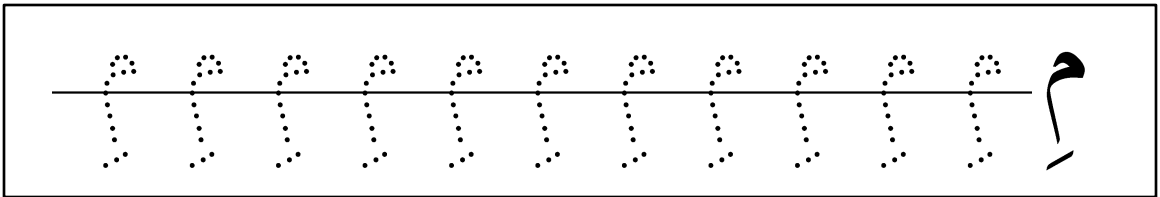
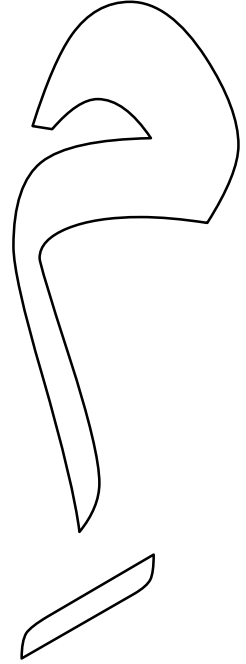
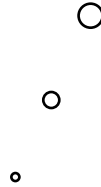
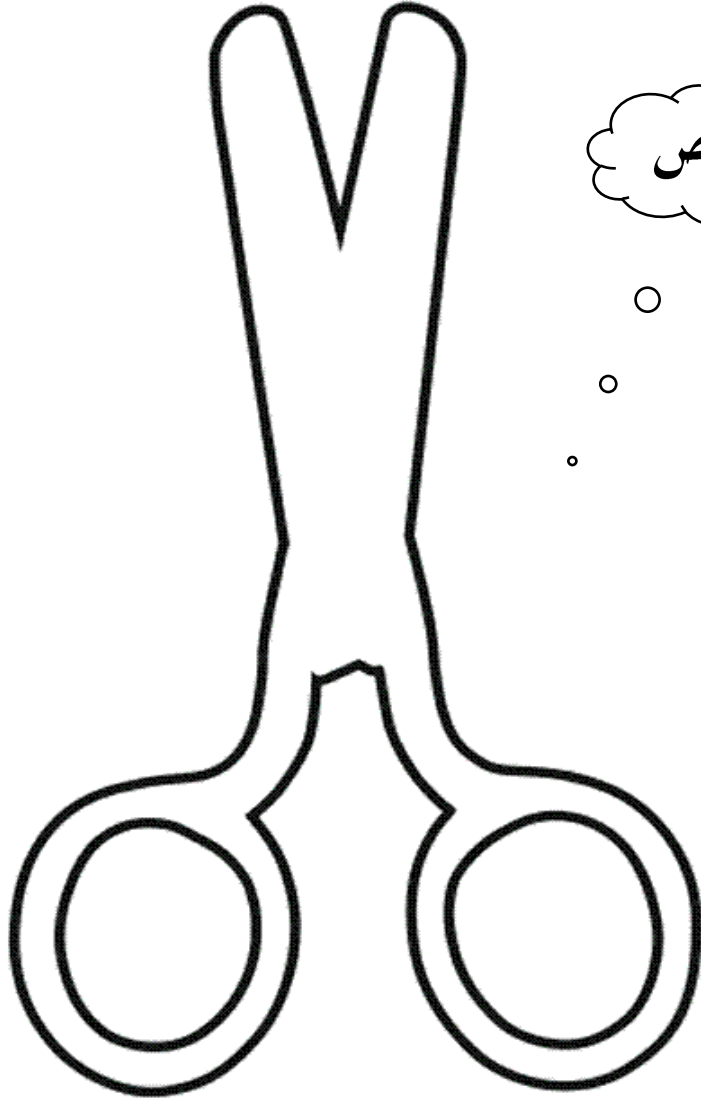

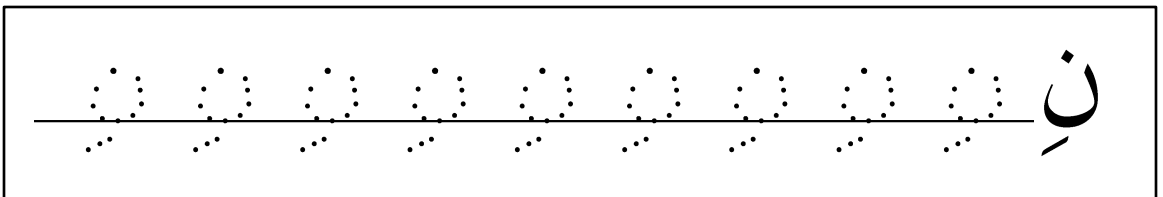
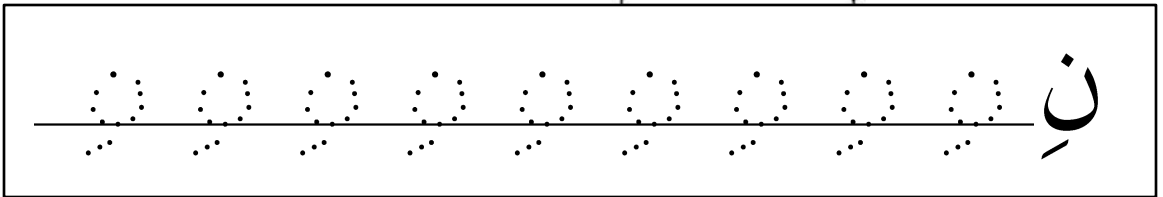
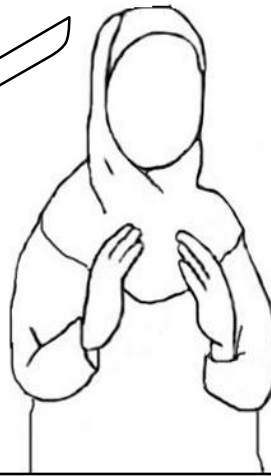
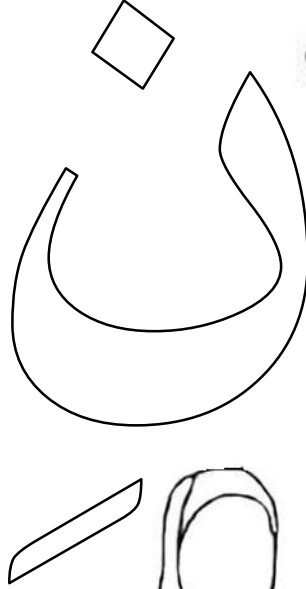

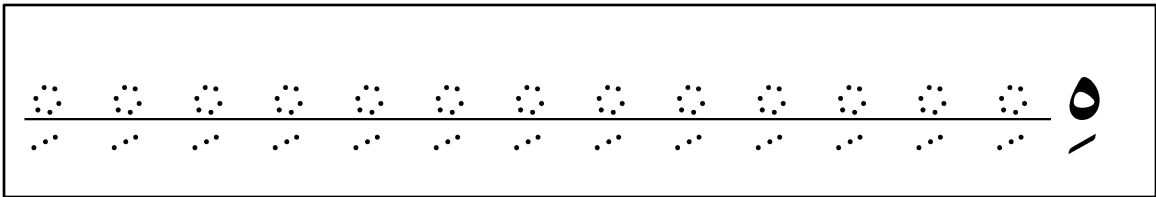
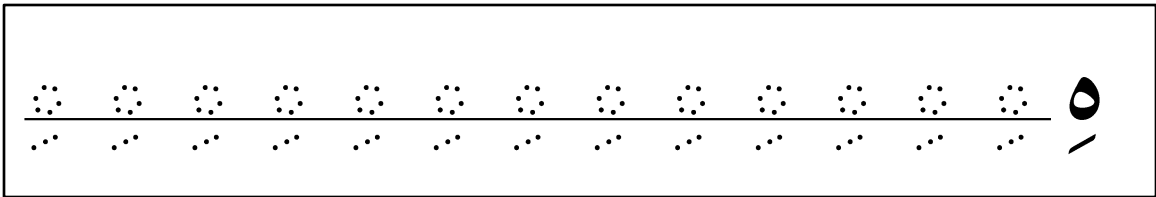
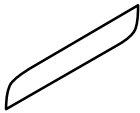
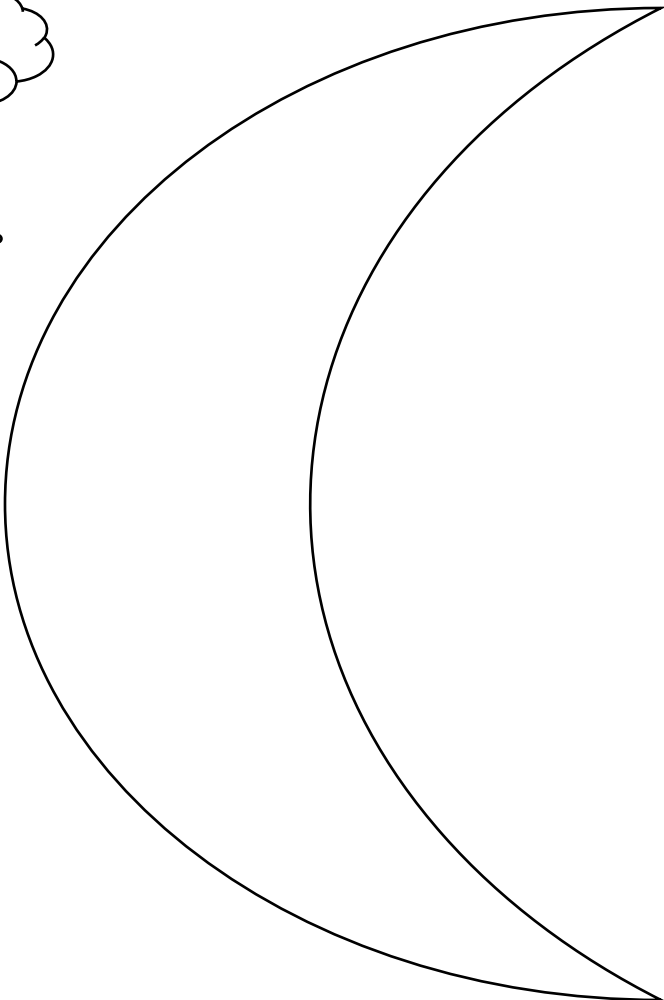
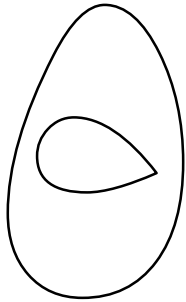

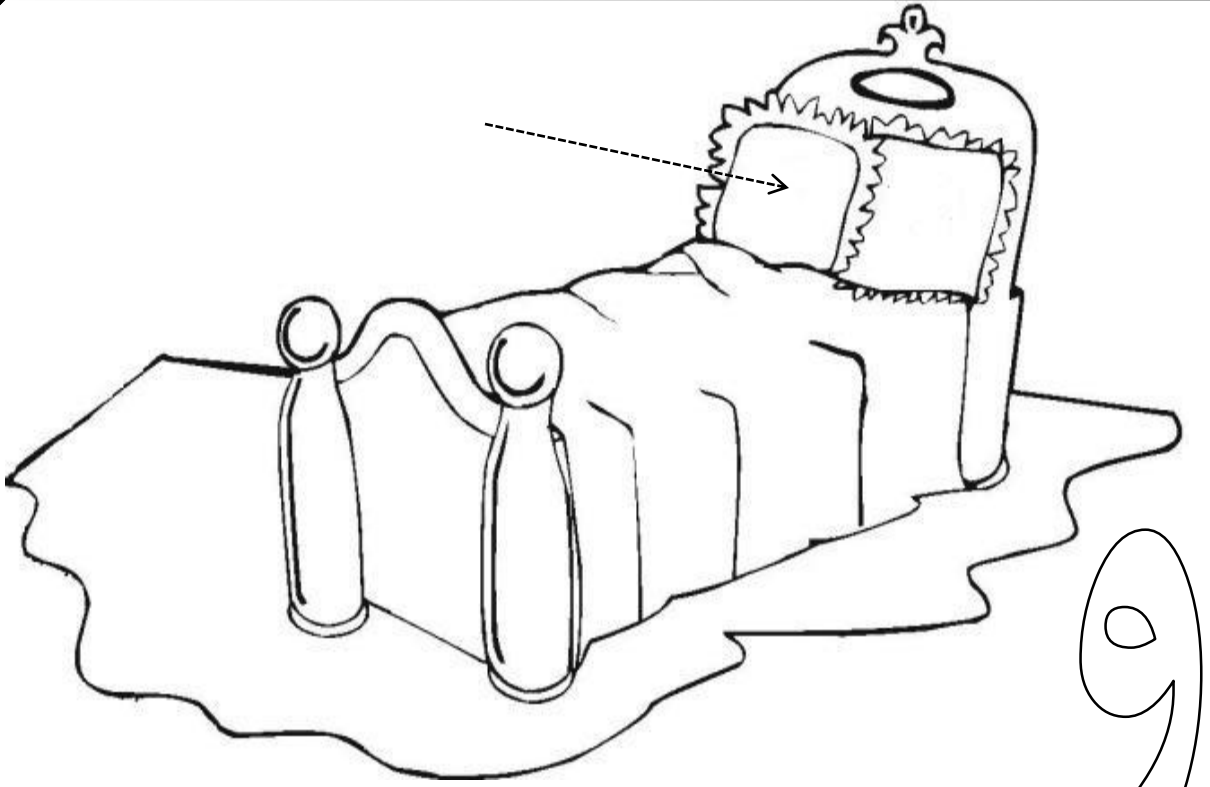

وَسَادَةَ

