

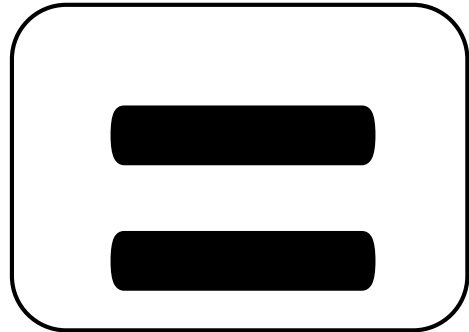

Date :

Prénom :

 Découpe et  colle les étiquettes au bon endroit.

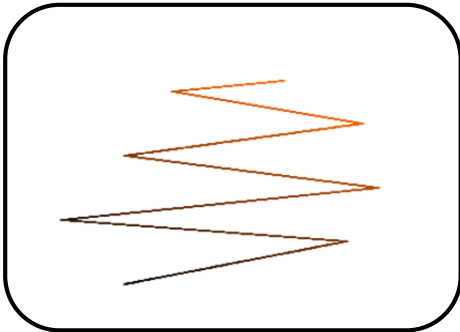
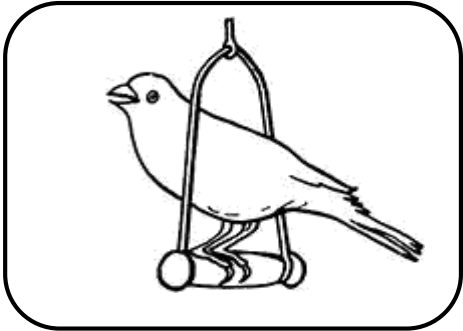
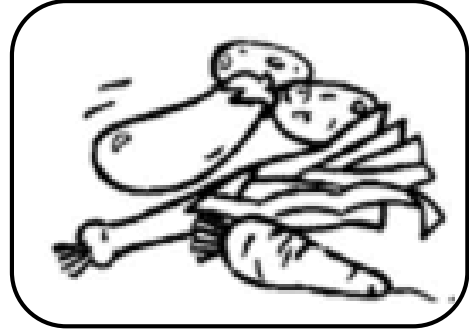
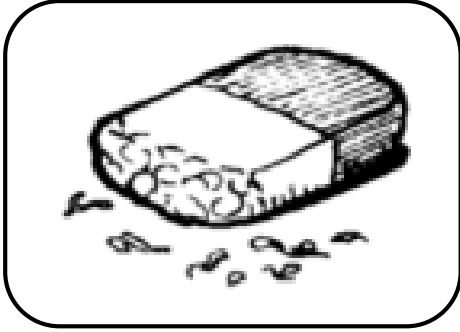

des légumes	le rugby	une virgule	un zigzag	un canari
une gomme	une gare	égal	la mygale	



Date :

Prénom :



Ecris le mot correspondant à l'image.

une gare

des légumes

un zigzag

une virgule

la mygale

égal

le rugby

une gomme

un canari

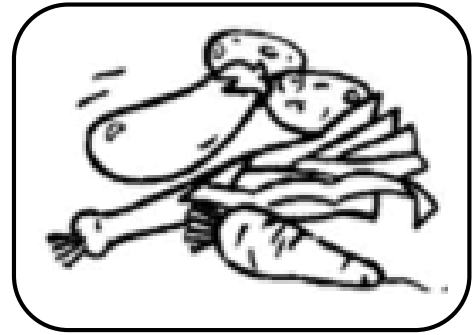
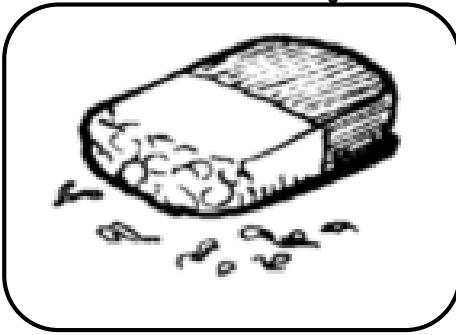

Handwriting practice grid with a blue dot on the left line.

Handwriting practice grid with a blue dot on the left line.

Handwriting practice grid with a blue dot on the left line.

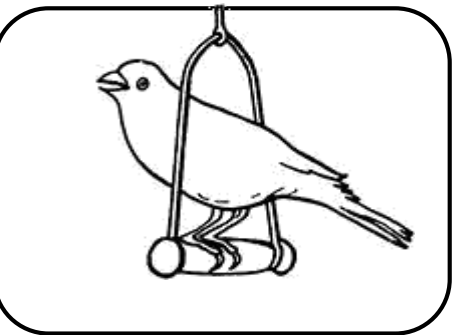

Handwriting practice grid with a blue dot on the left line.

Handwriting practice grid with a blue dot on the left line.

Handwriting practice grid with a blue dot on the left line.

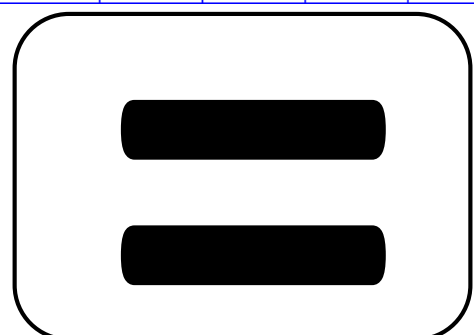
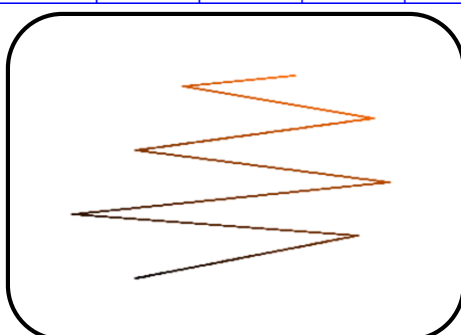

Handwriting practice grid with a blue dot on the left line.

Handwriting practice grid with a blue dot on the left line.

Handwriting practice grid with a blue dot on the left line.



Date :

Prénom :



Ecris le mot correspondant à l'image.

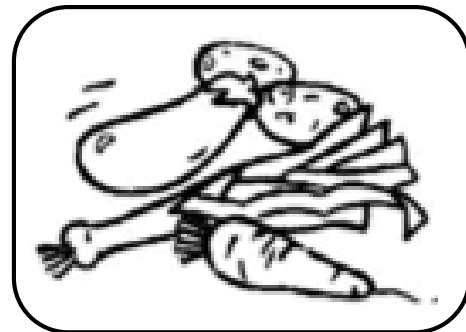
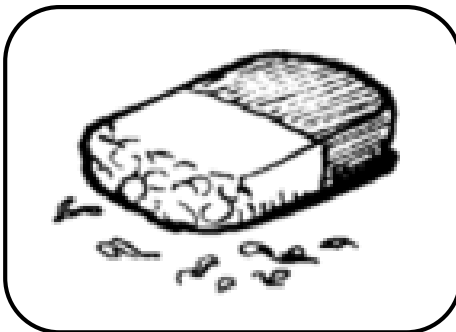

Handwriting practice grid with a blue dot on the top line.

Handwriting practice grid with a blue dot on the top line.

Handwriting practice grid with a blue dot on the top line.

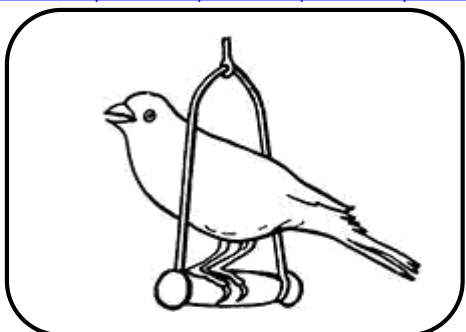

Handwriting practice grid with a blue dot on the top line.

Handwriting practice grid with a blue dot on the top line.

Handwriting practice grid with a blue dot on the top line.

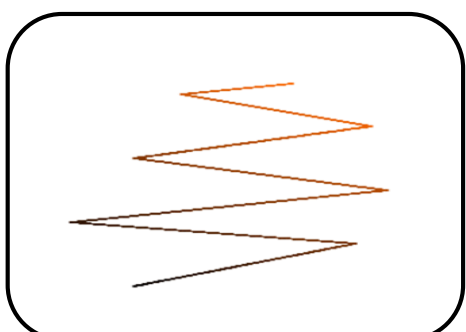

Handwriting practice grid with a blue dot on the top line.

Handwriting practice grid with a blue dot on the top line.

Handwriting practice grid with a blue dot on the top line.



Date :

Prénom :

 Découpe et  colle les étiquettes au bon endroit.

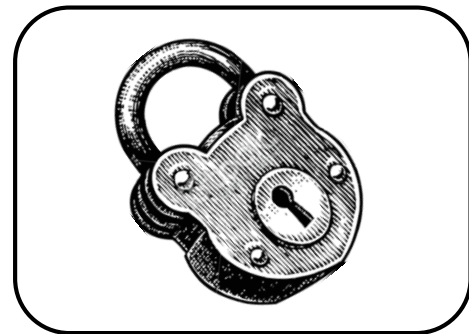
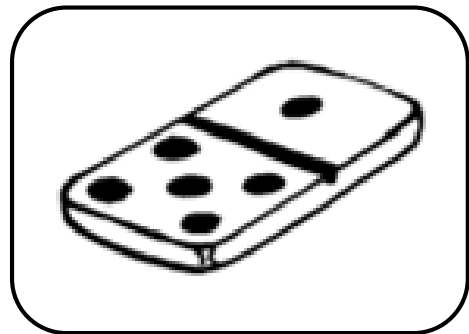
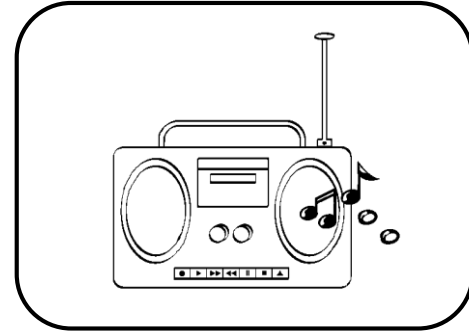
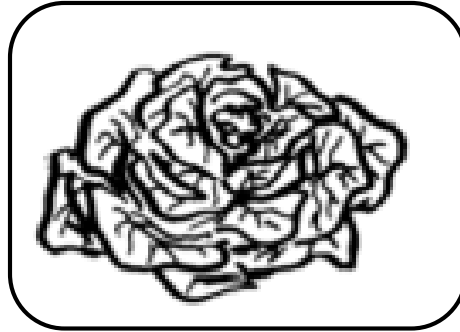
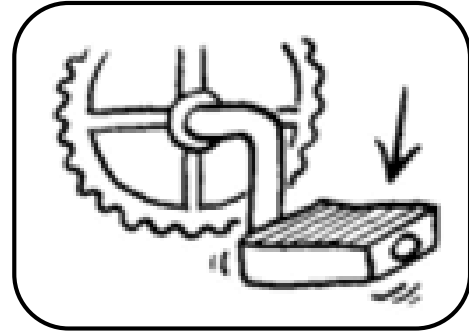
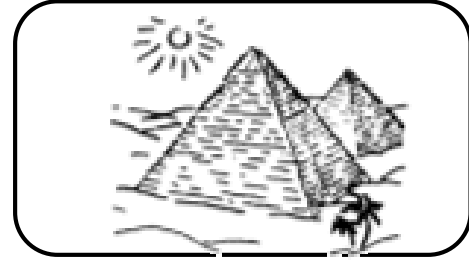
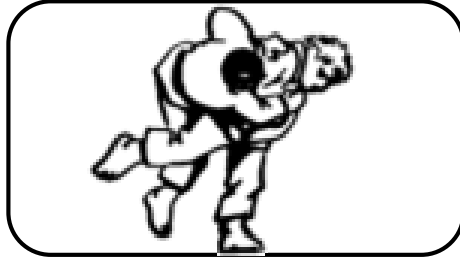

la douche	les pyramides	un domino	une dame	le judo
une salade	une pédale	la radio	un cadenas	



Date :

Prénom :



Ecris le mot correspondant à l'image.

la douche

les pyramides

un cadenas

une salade

la radio

le judo

une pédale

une dame

un domino

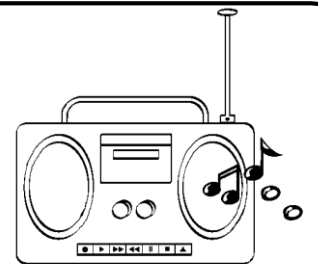
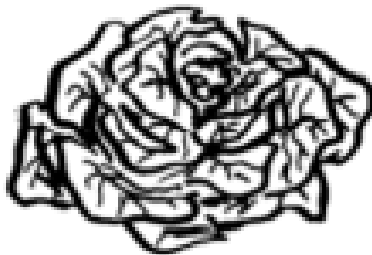
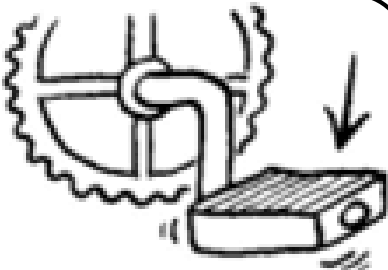
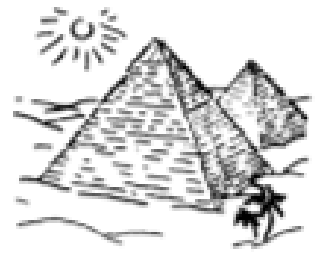
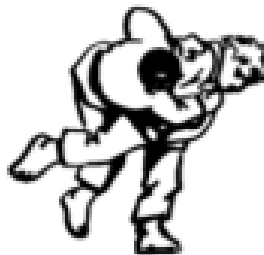



Date :

Prénom :



Ecris le mot correspondant à l'image.

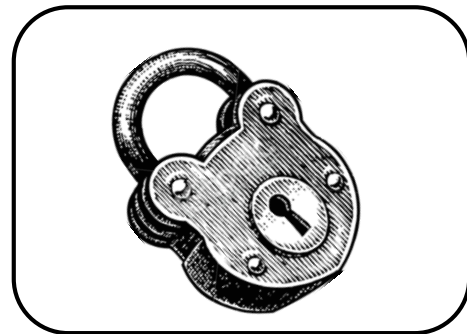
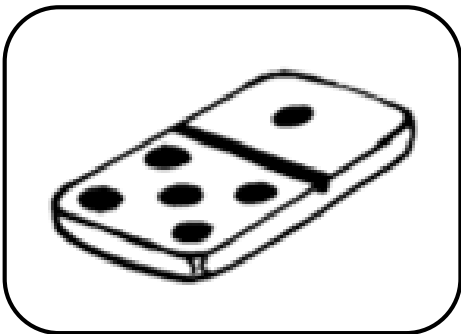
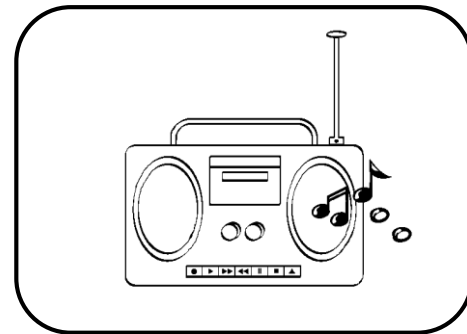
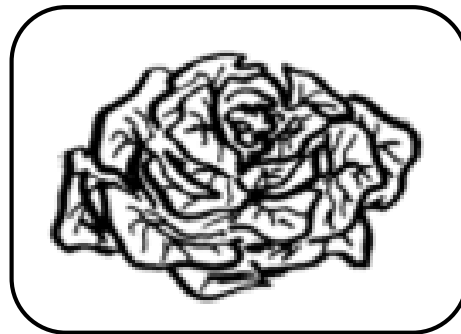
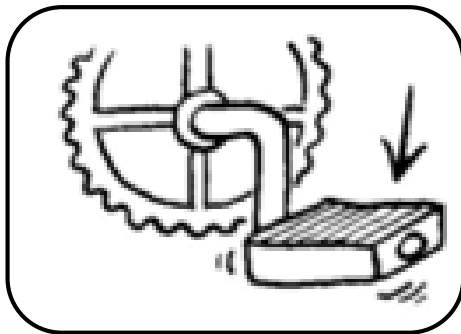
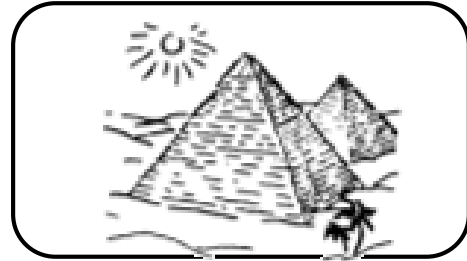
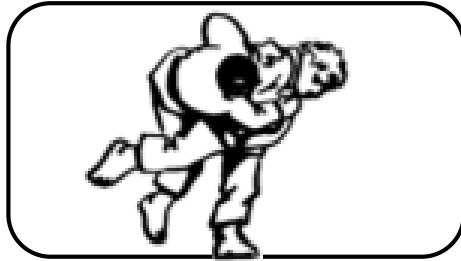
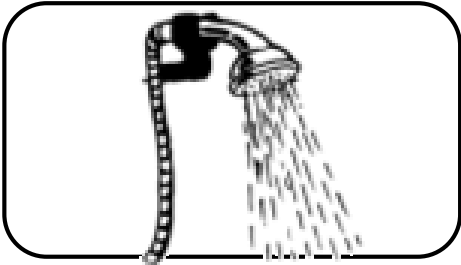



Date :

Prénom :

 Découpe et  colle les étiquettes au bon endroit.

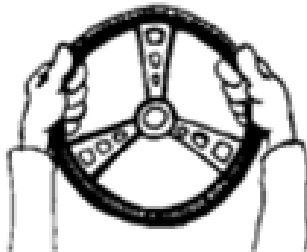
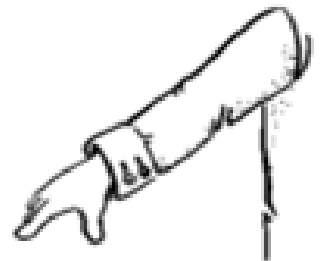
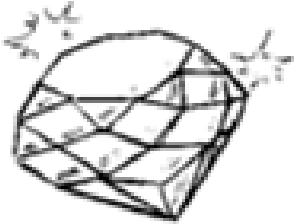

la manche

une enveloppe

des enfants

un volant

une dent

une maman

une amande

un diamant

un panda



Date :

Prénom :



Ecris le mot correspondant à l'image.

la manche

un diamant

une maman

une dent

un volant

une amande

des enfants

un panda

une enveloppe

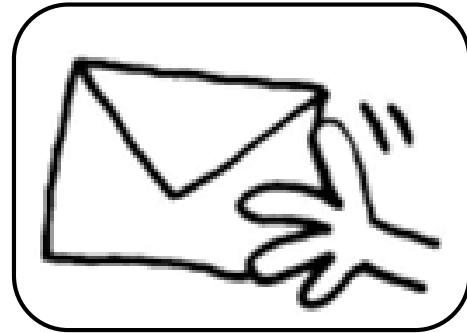
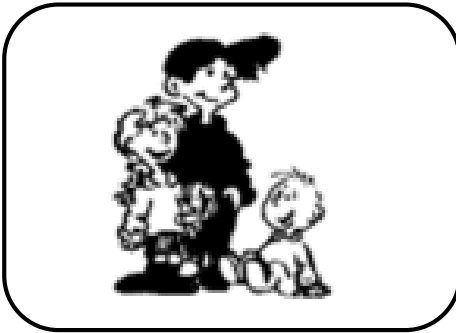
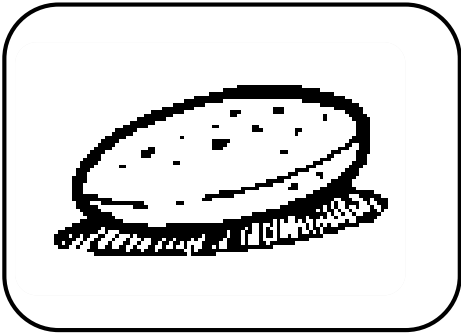

Handwriting practice grid with a blue starting dot.

Handwriting practice grid with a blue starting dot.

Handwriting practice grid with a blue starting dot.

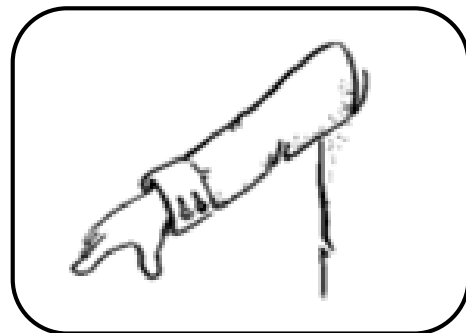
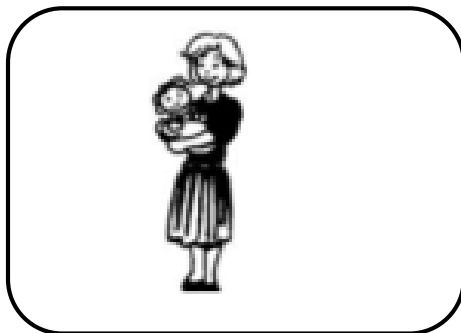
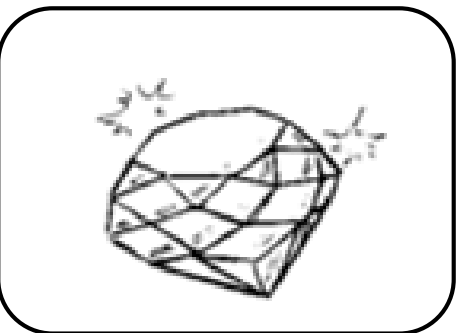

Handwriting practice grid with a blue starting dot.

Handwriting practice grid with a blue starting dot.

Handwriting practice grid with a blue starting dot.

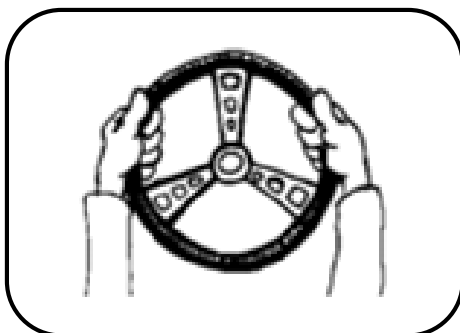
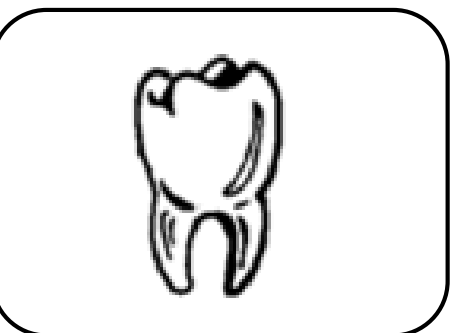

Handwriting practice grid with a blue starting dot.

Handwriting practice grid with a blue starting dot.

Handwriting practice grid with a blue starting dot.





Date :

Prénom :



Ecris le mot correspondant à l'image.

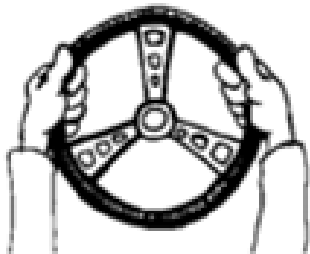
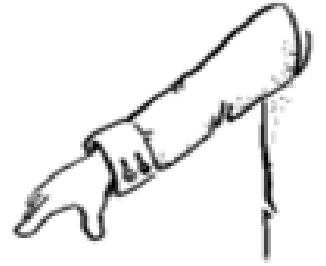



Date :

Prénom :



Découpe et



colle les étiquettes au bon endroit.

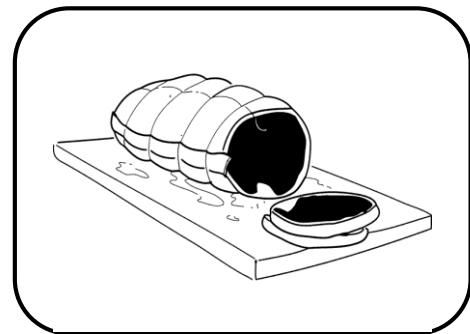
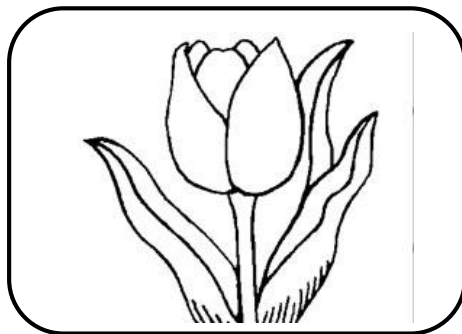
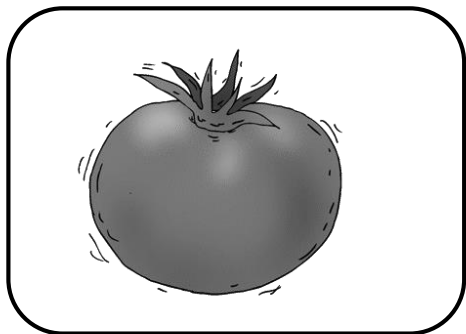
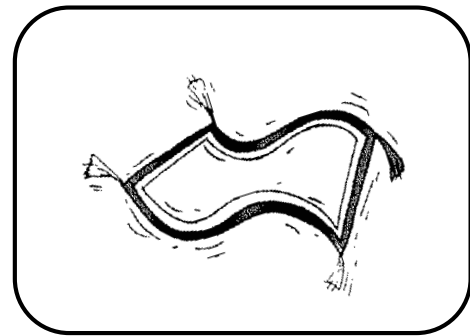
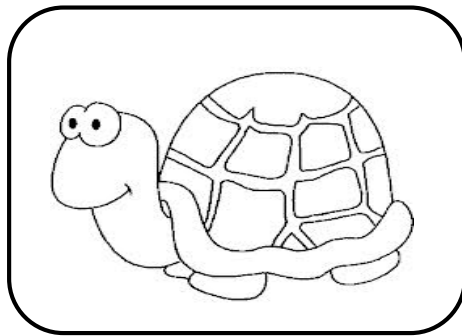
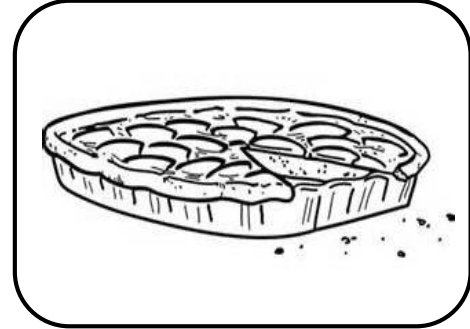
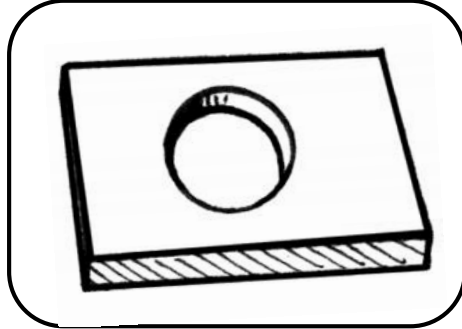
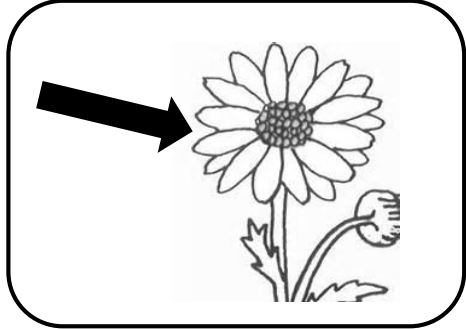

un pétale	un tapis	le pirate	la tulipe	une tomate
une tortue	un rôti	un trou	une tarte	



Date :

Prénom :



Ecris le mot correspondant à l'image.

un pétale

un rôti

la tulipe

une tortue

le pirate

une tarte

un tapis

un trou

une tomate

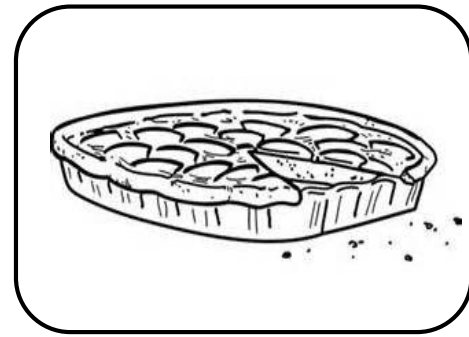
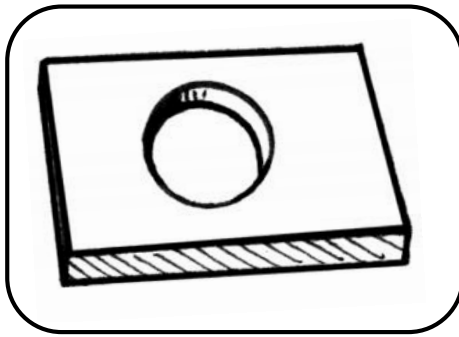
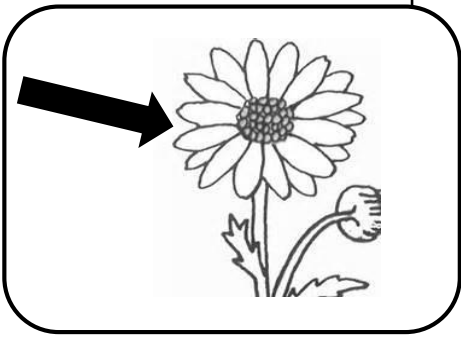

Handwriting practice grid with a blue starting dot.

Handwriting practice grid with a blue starting dot.

Handwriting practice grid with a blue starting dot.

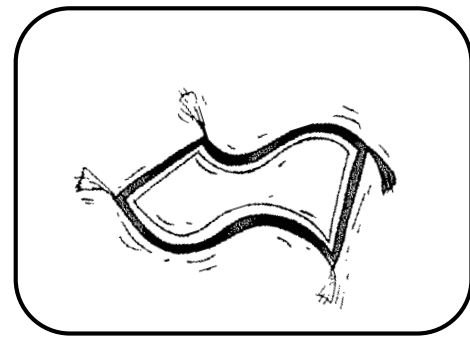
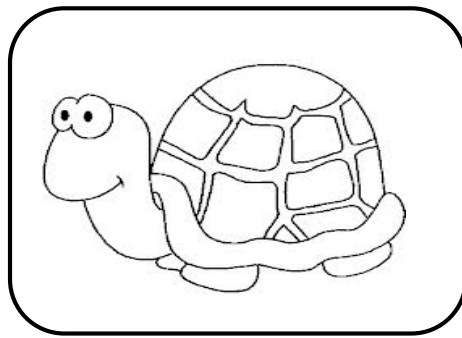

Handwriting practice grid with a blue starting dot.

Handwriting practice grid with a blue starting dot.

Handwriting practice grid with a blue starting dot.

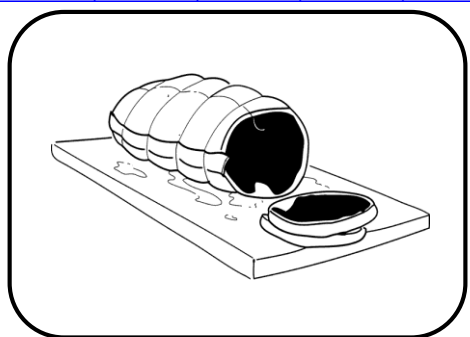
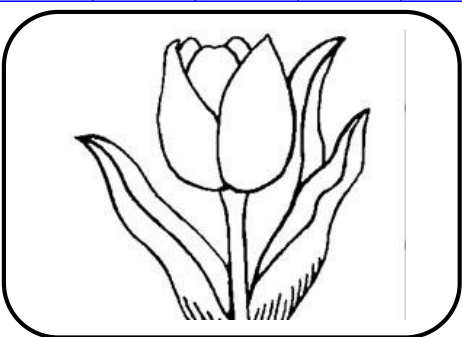
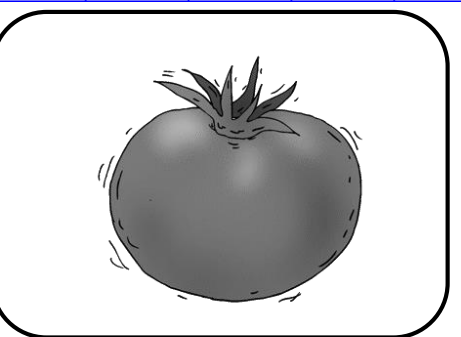

Handwriting practice grid with a blue starting dot.

Handwriting practice grid with a blue starting dot.

Handwriting practice grid with a blue starting dot.



Date :

Prénom :



Ecris le mot correspondant à l'image.

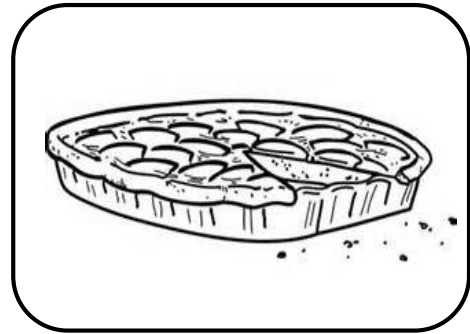
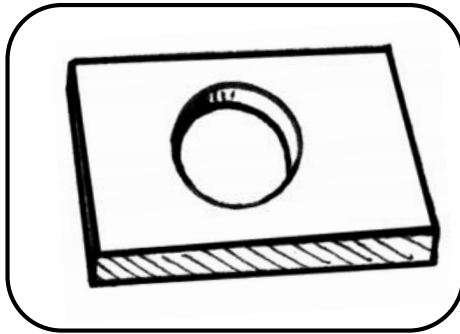
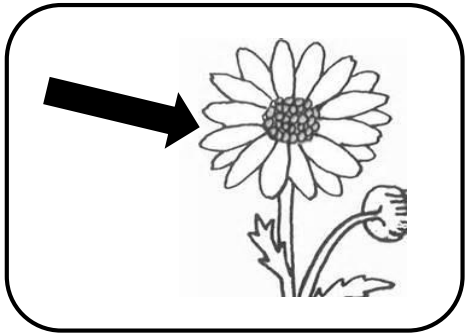

Handwriting practice grid for the word 'fleur'.

Handwriting practice grid for the word 'anneau'.

Handwriting practice grid for the word 'tarte'.

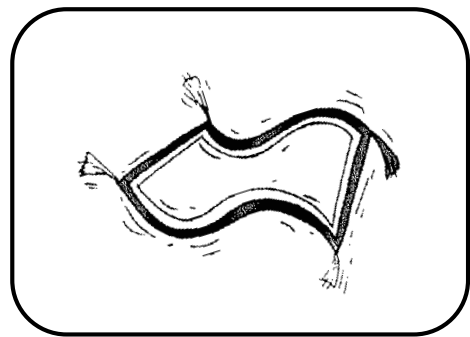
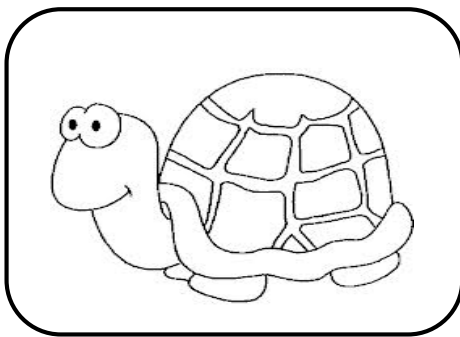

Handwriting practice grid for the word 'pirate'.

Handwriting practice grid for the word 'tortue'.

Handwriting practice grid for the word 'drapeau'.

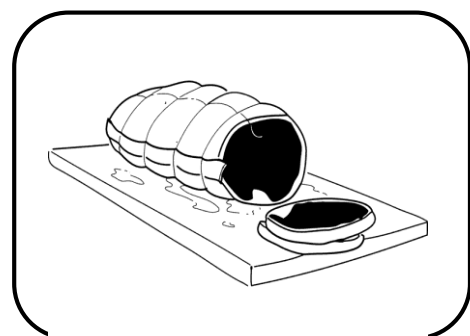
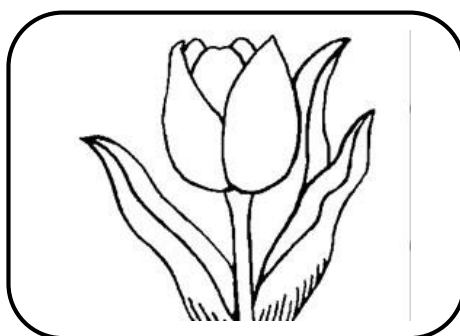

Handwriting practice grid for the word 'tomate'.

Handwriting practice grid for the word 'tulipe'.

Handwriting practice grid for the word 'tapis'.



Découpe et



colle les étiquettes au bon endroit.

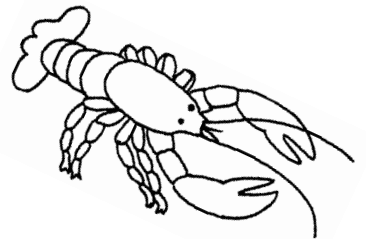
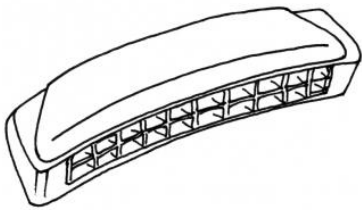
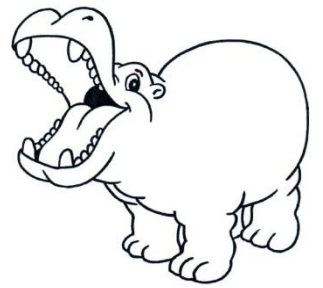
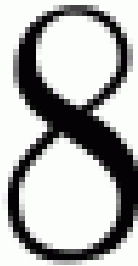

un hélicoptère

le hamac

du houx

un harmonica

une harpe

huit

un homard

un hibou

un  
hippopotame





Date :

Prénom :



Ecris le mot correspondant à l'image.

huit

le hamac

un harmonica

un homard

du houx

un hippopotame

l'hélicoptère

un hibou

une harpe

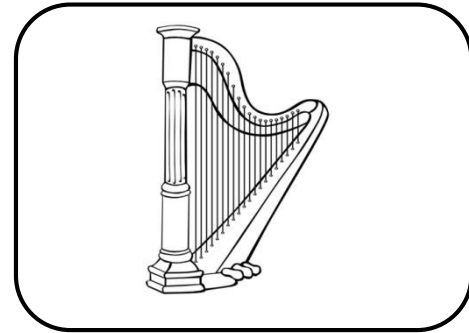
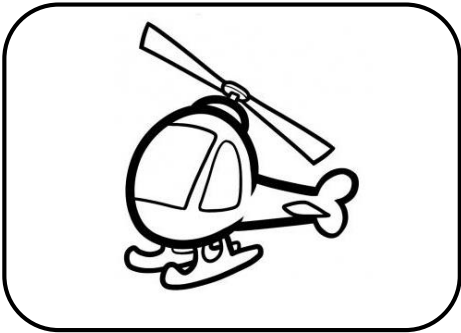

Handwriting practice lines with a blue dot on the left.

Handwriting practice lines with a blue dot on the left.

Handwriting practice lines with a blue dot on the left.

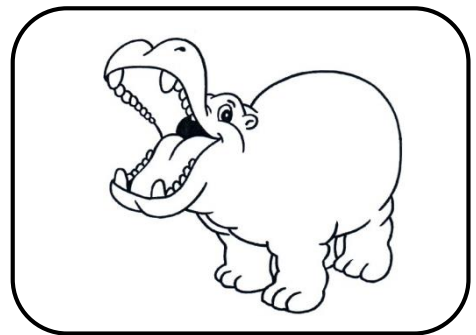
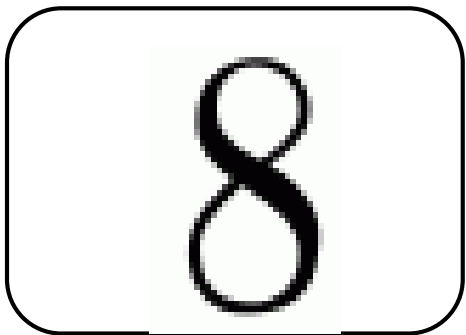

Handwriting practice lines with a blue dot on the left.

Handwriting practice lines with a blue dot on the left.

Handwriting practice lines with a blue dot on the left.

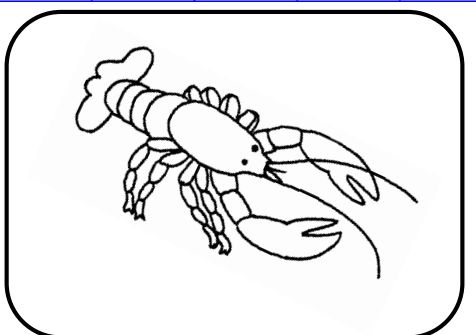
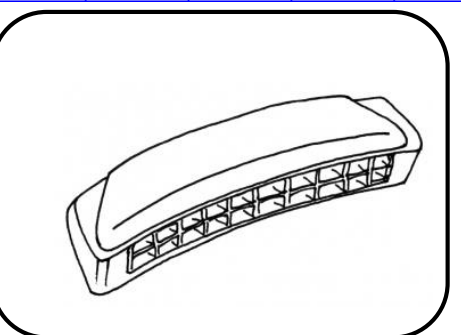

Handwriting practice lines with a blue dot on the left.

Handwriting practice lines with a blue dot on the left.

Handwriting practice lines with a blue dot on the left.



Date :

Prénom :



Ecris le mot correspondant à l'image.

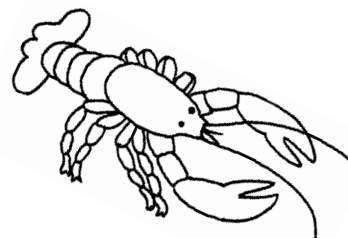
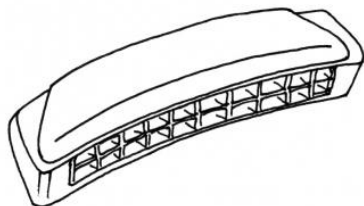
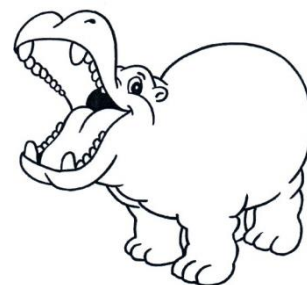
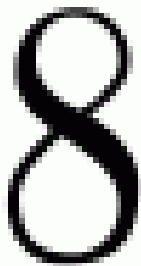
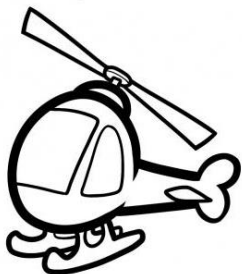



Découpe et



colle les étiquettes au bon endroit.

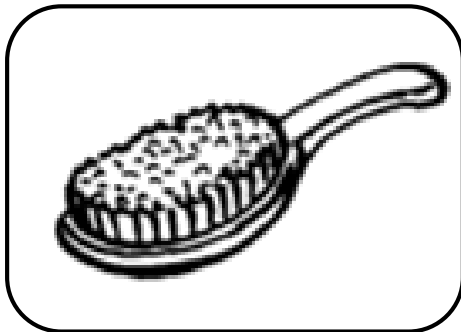
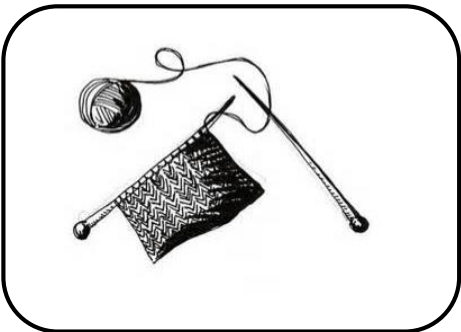
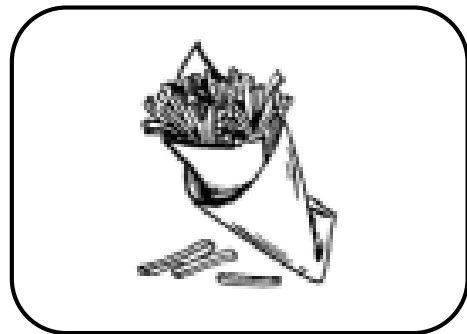
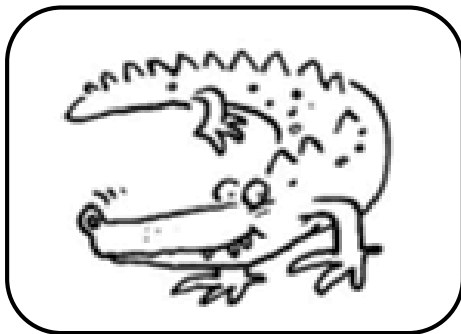
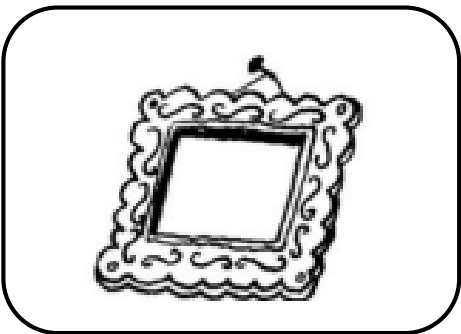
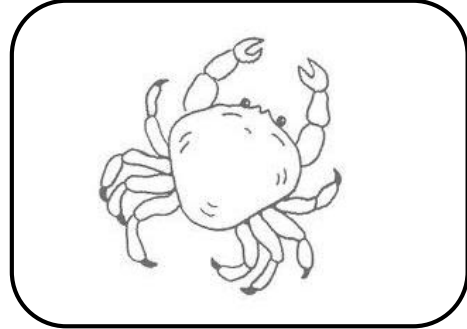
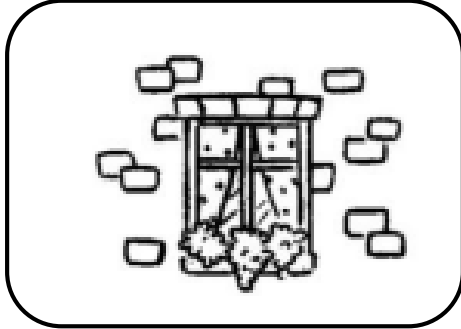

un arbre	un tricot	une fenêtre	un crabe	un micro
un cadre	une brosse	des frites	un crocodile	





Date :

Prénom :



Ecris le mot correspondant à l'image.

un arbre

la brosse

un crabe

un cadre

la fenêtre

des frites

un tricot

un micro

un crocodile

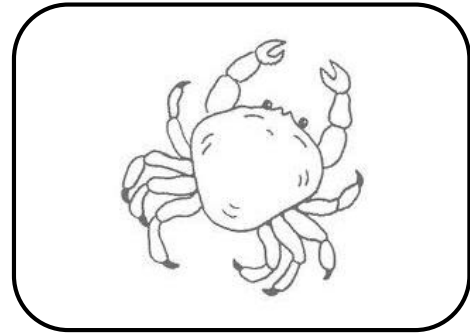
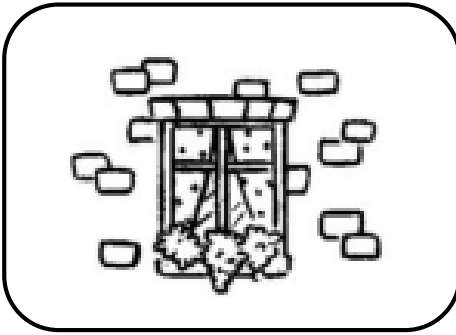

Handwriting practice lines for the word 'un arbre'.

Handwriting practice lines for the word 'la fenêtre'.

Handwriting practice lines for the word 'un crabe'.

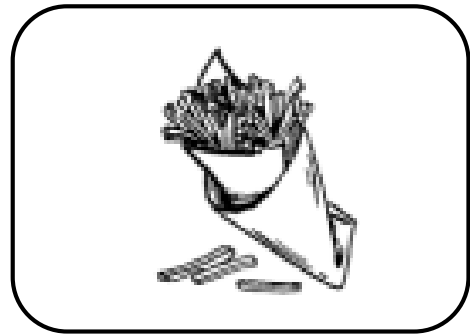
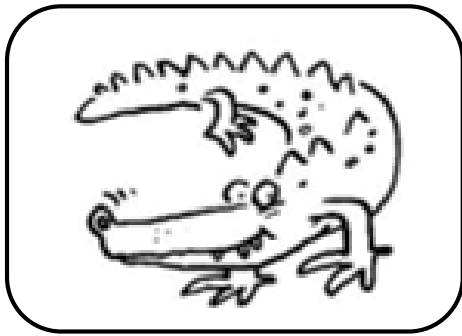
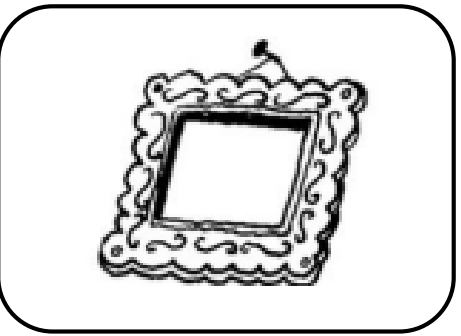

Handwriting practice lines for the word 'un cadre'.

Handwriting practice lines for the word 'un crocodile'.

Handwriting practice lines for the word 'des frites'.

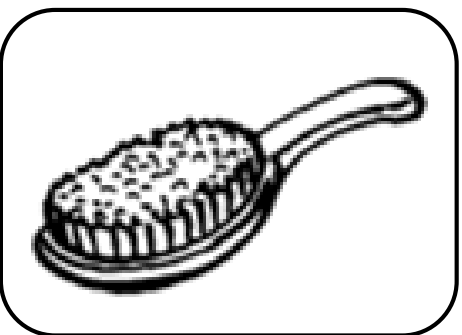
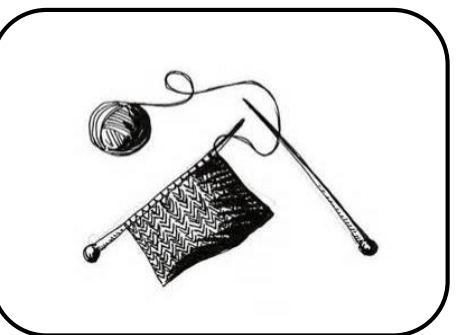

Handwriting practice lines for the word 'un tricot'.

Handwriting practice lines for the word 'la brosse'.

Handwriting practice lines for the word 'un micro'.



Date :

Prénom :



Ecris le mot correspondant à l'image.

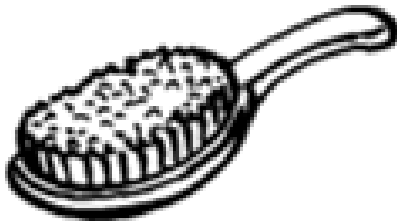
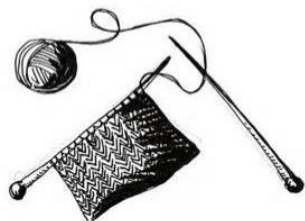
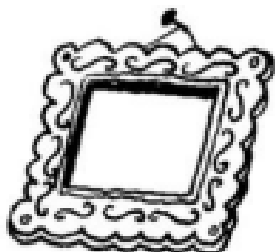
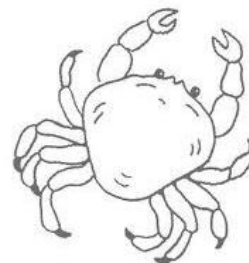
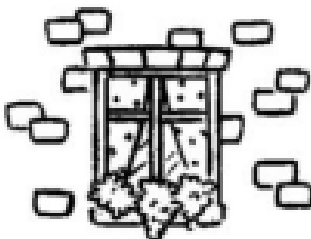



Date :

Prénom :



Découpe et



colle les étiquettes au bon endroit.

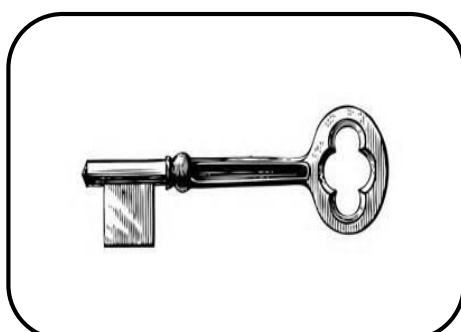
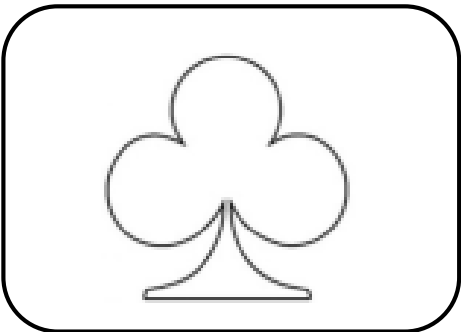
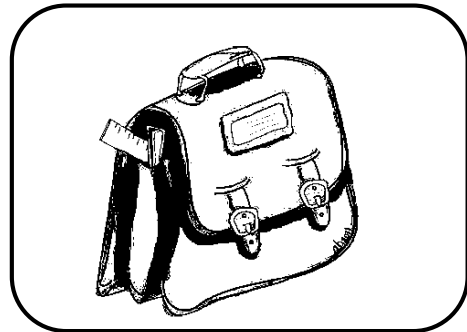
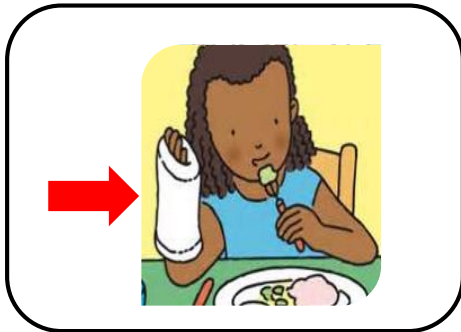
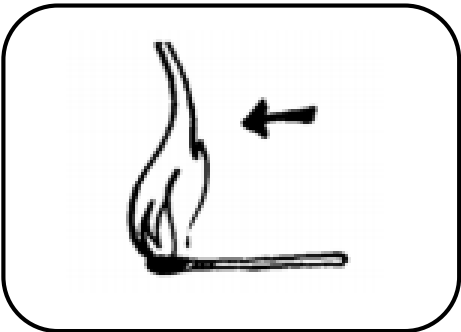
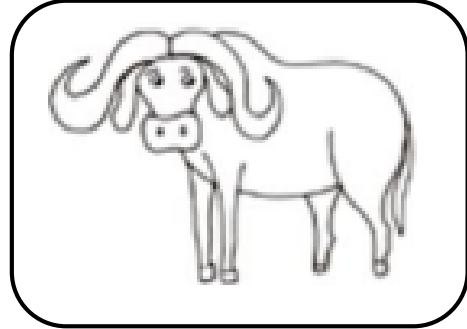
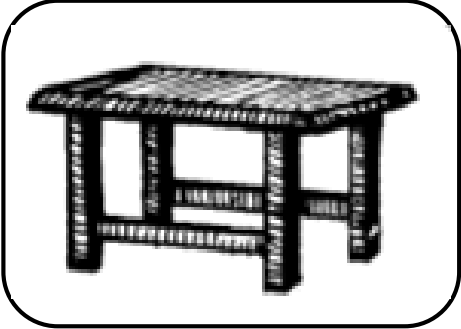

une table	la pluie	un buffle	une plume	une clé
un plâtre	une flamme	le trèfle	un cartable	



Date :

Prénom :



Ecris le mot correspondant à l'image.

une table

une flamme

un buffle

la pluie

une plume

un cartable

un plâtre

une clé

le trèfle

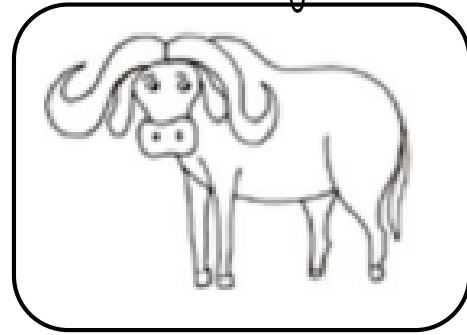
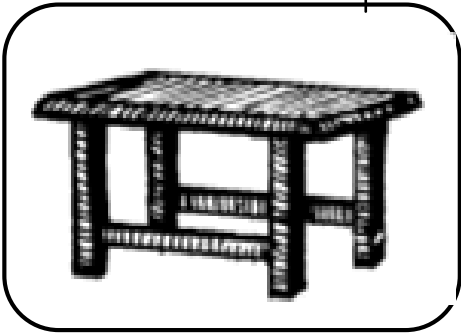

Handwriting practice lines for the word 'table'.

Handwriting practice lines for the word 'pluie'.

Handwriting practice lines for the word 'buffle'.

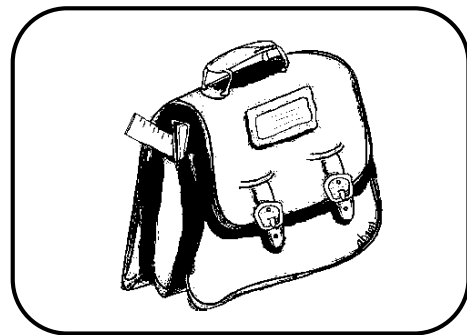
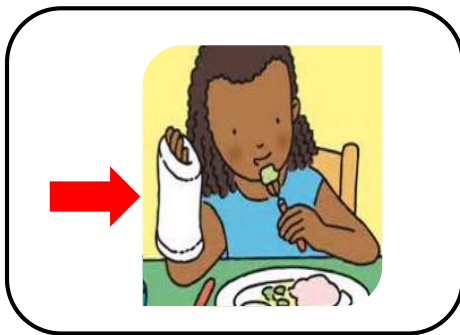
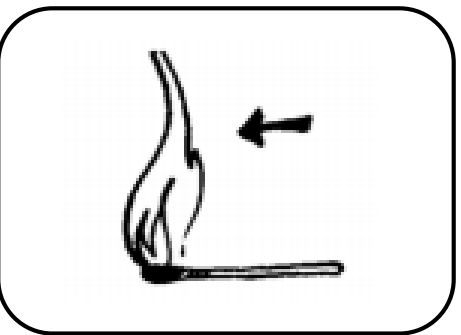

Handwriting practice lines for the word 'flamme'.

Handwriting practice lines for the word 'plâtre'.

Handwriting practice lines for the word 'cartable'.

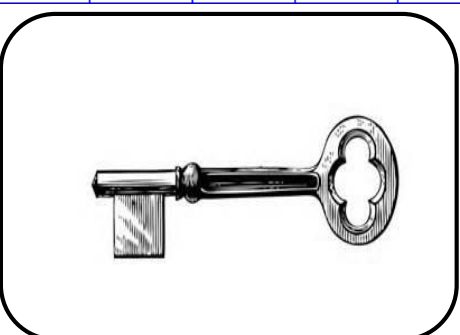
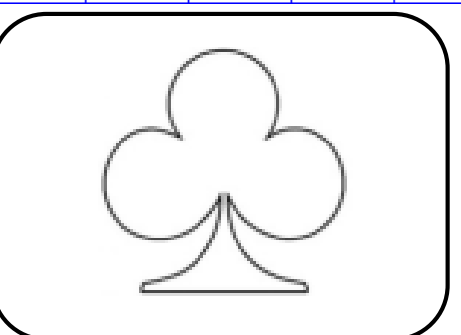

Handwriting practice lines for the word 'trèfle'.

Handwriting practice lines for the word 'clé'.

Handwriting practice lines for the word 'plume'.



Date :

Prénom :



Ecris le mot correspondant à l'image.

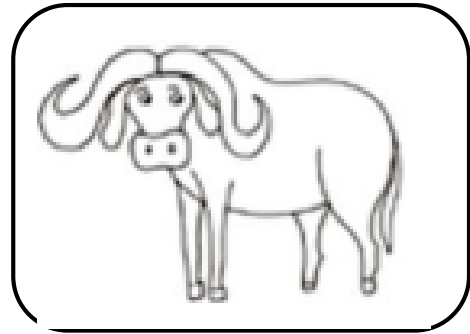
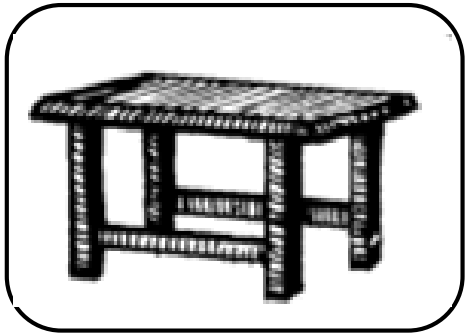

Handwriting practice grid with a blue dot on the top line.

Handwriting practice grid with a blue dot on the top line.

Handwriting practice grid with a blue dot on the top line.

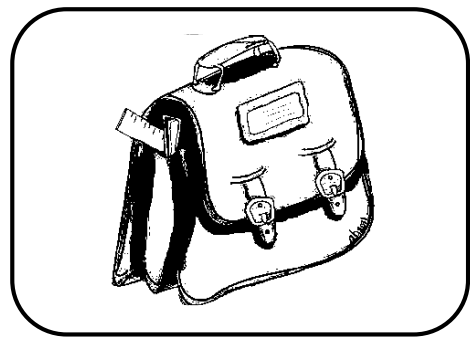
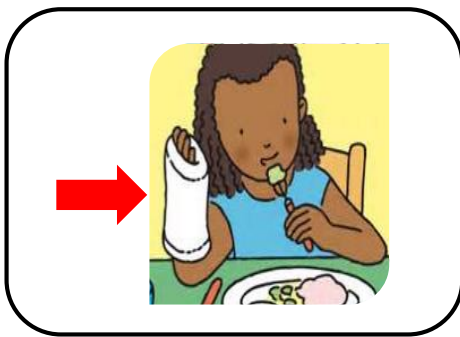
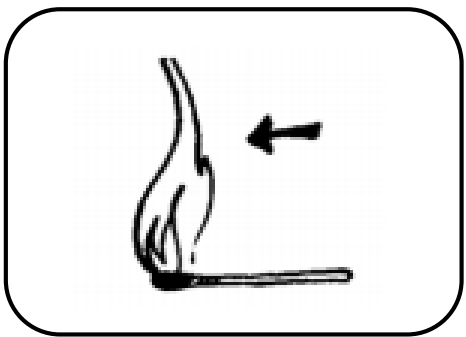

Handwriting practice grid with a blue dot on the top line.

Handwriting practice grid with a blue dot on the top line.

Handwriting practice grid with a blue dot on the top line.

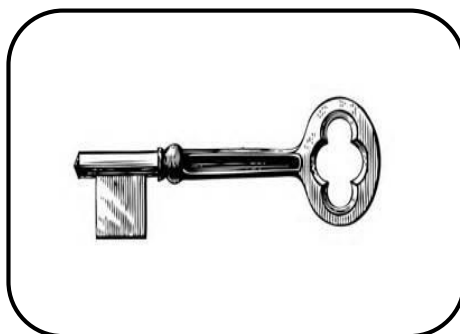
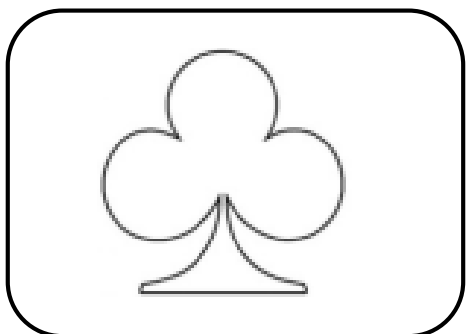

Handwriting practice grid with a blue dot on the top line.

Handwriting practice grid with a blue dot on the top line.

Handwriting practice grid with a blue dot on the top line.



Découpe et colle les étiquettes au bon endroit.

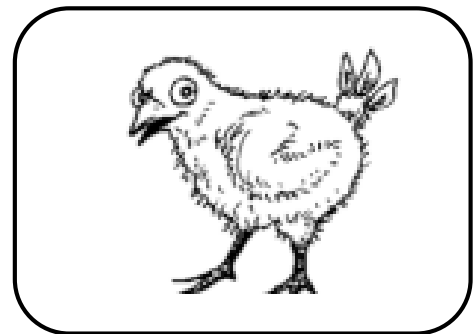
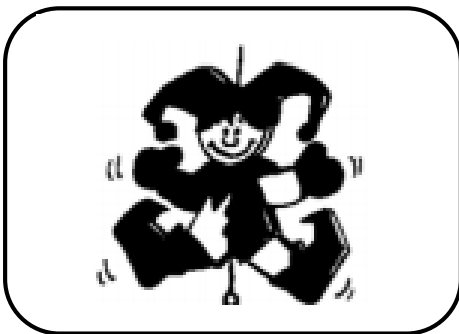
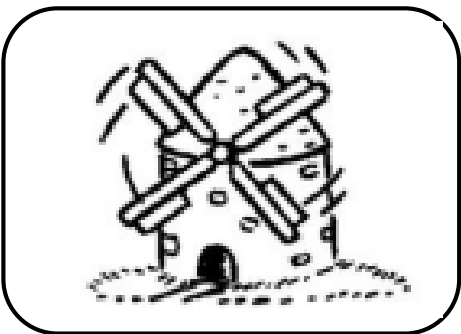
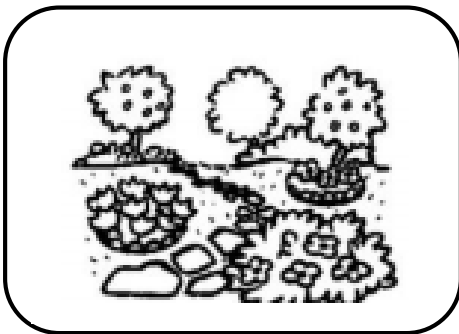
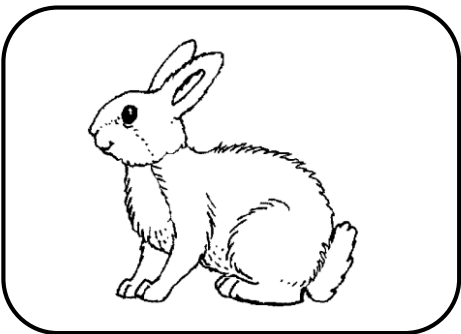
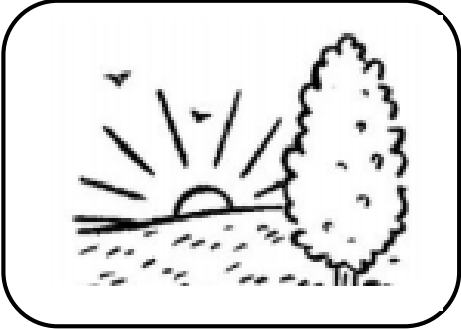

un marin	un lapin	un pantin	un moulin	le matin
le chemin	un patin	un poussin	vingt	



Date :

Prénom :



Ecris le mot correspondant à l'image.

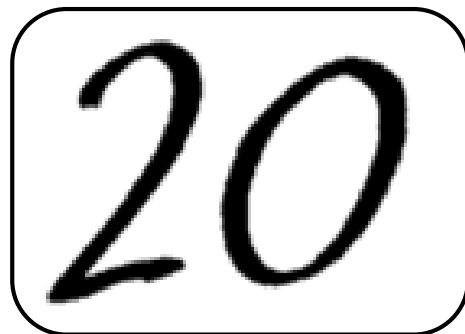
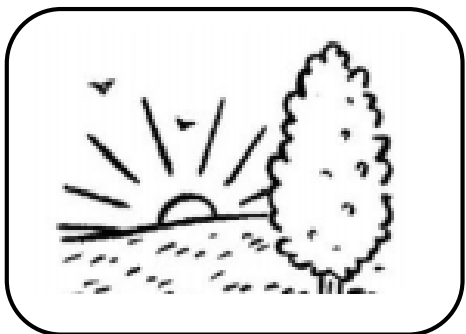

Handwriting practice grid with a starting dot.

Handwriting practice grid with a starting dot.

Handwriting practice grid with a starting dot.

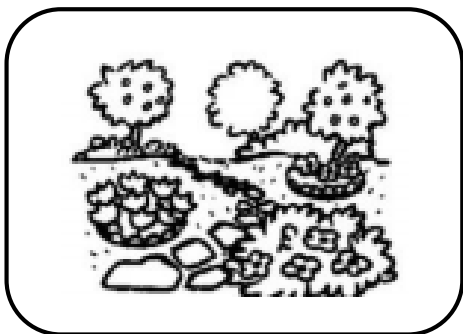
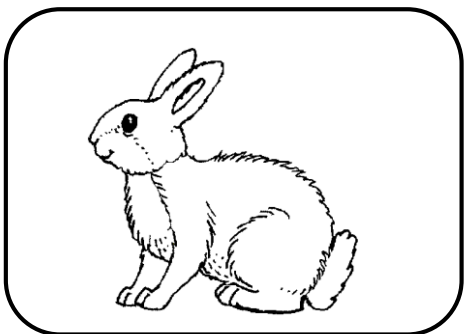

Handwriting practice grid with a starting dot.

Handwriting practice grid with a starting dot.

Handwriting practice grid with a starting dot.

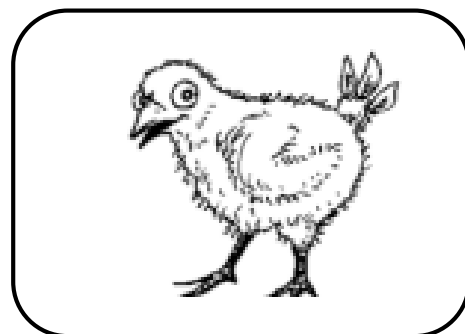
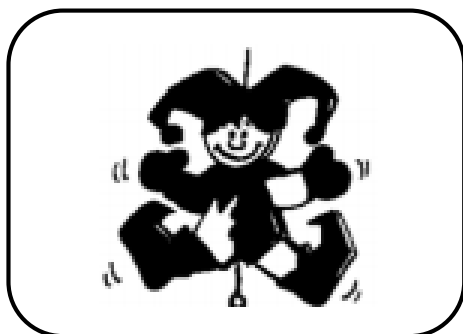
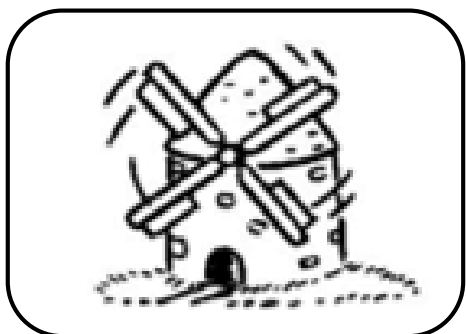

Handwriting practice grid with a starting dot.

Handwriting practice grid with a starting dot.

Handwriting practice grid with a starting dot.



Ecris le mot correspondant à l'image.

un marin

un pantin

vingt

le chemin

un poussin

le matin

un lapin

un moulin

un patin

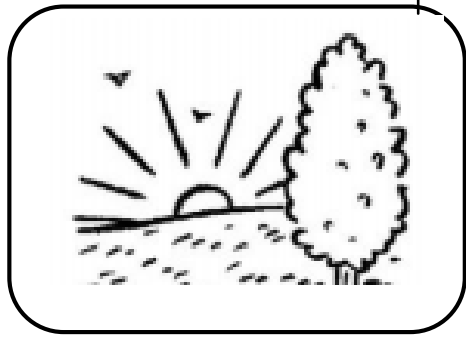

Handwriting practice grid with a blue dot on the left line.

Handwriting practice grid with a blue dot on the left line.

Handwriting practice grid with a blue dot on the left line.

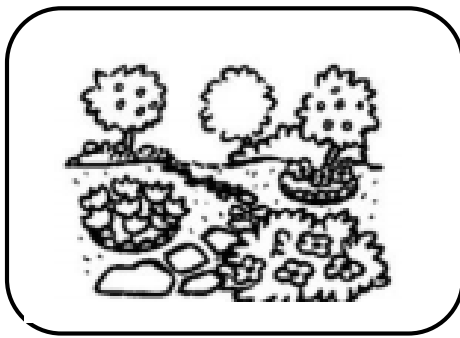
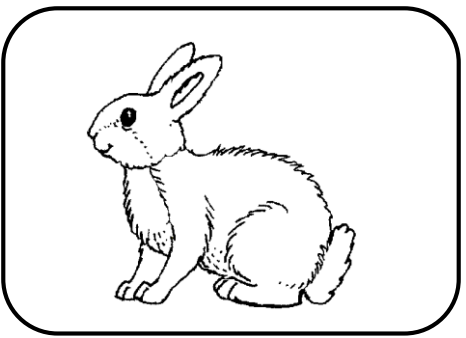

Handwriting practice grid with a blue dot on the left line.

Handwriting practice grid with a blue dot on the left line.

Handwriting practice grid with a blue dot on the left line.

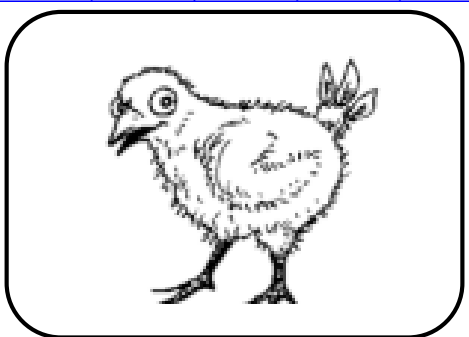
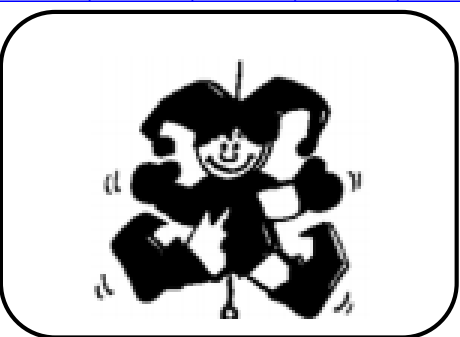

Handwriting practice grid with a blue dot on the left line.

Handwriting practice grid with a blue dot on the left line.

Handwriting practice grid with a blue dot on the left line.





Date :

Prénom :



Découpe et



colle les étiquettes au bon endroit.

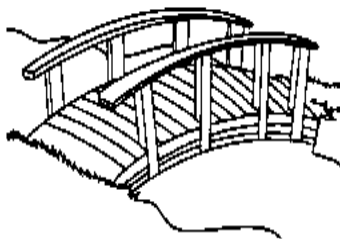
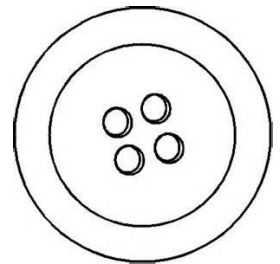
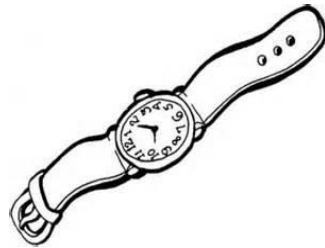
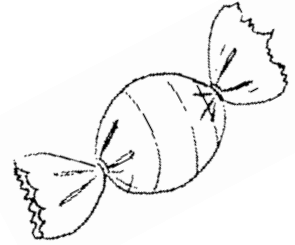

un avion

un melon

un bouton

un ballon

un biberon

le mouton

une montre

un poussin

un pont



Date :

Prénom :



Ecris le mot correspondant à l'image.

un avion

une montre

un ballon

le mouton

un bouton

le pont

un melon

un poussin

un biberon

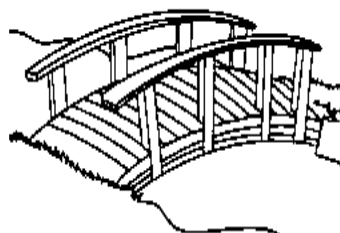
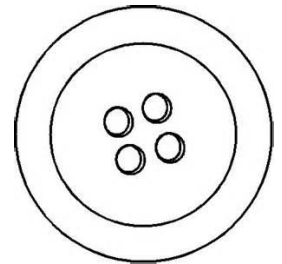
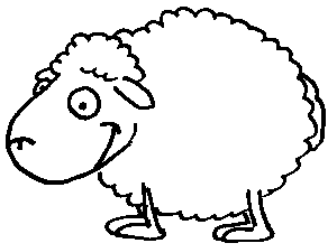
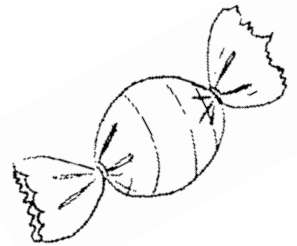



Date :

Prénom :



Ecris le mot correspondant à l'image.

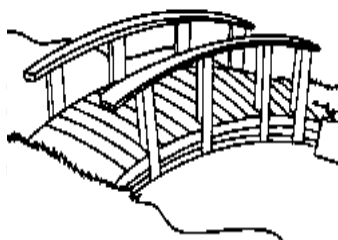
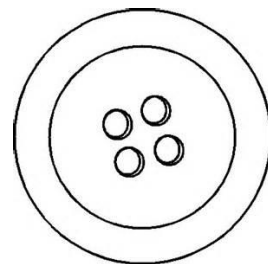



Découpe et colle les étiquettes au bon endroit.

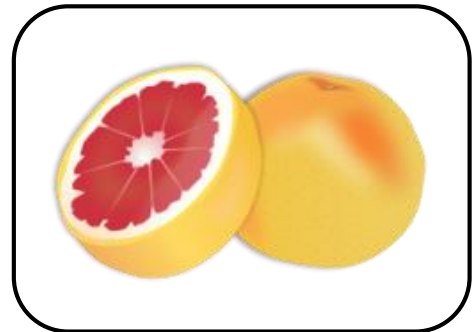
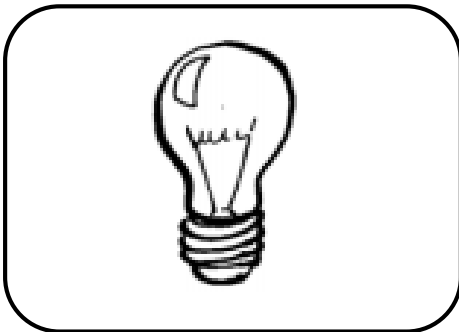
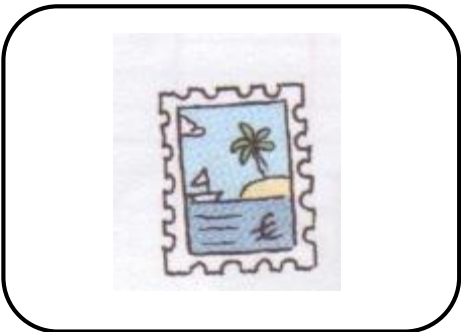
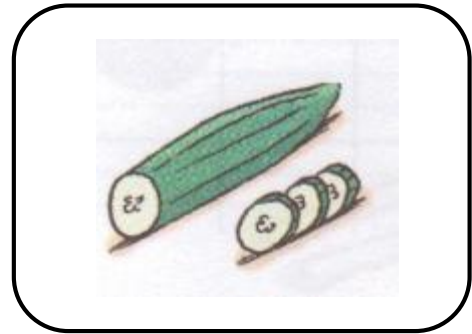
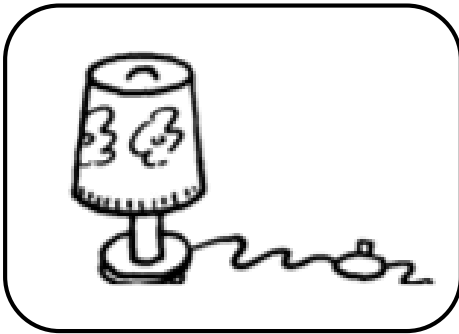
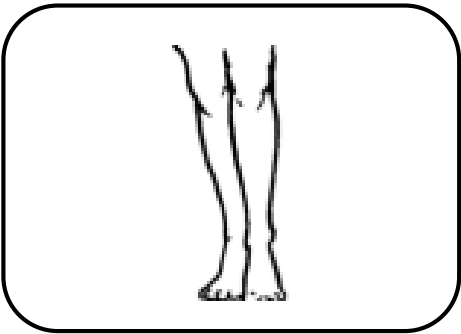
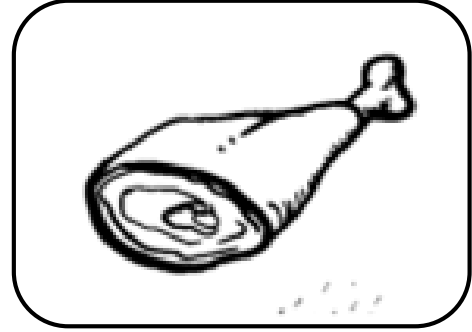
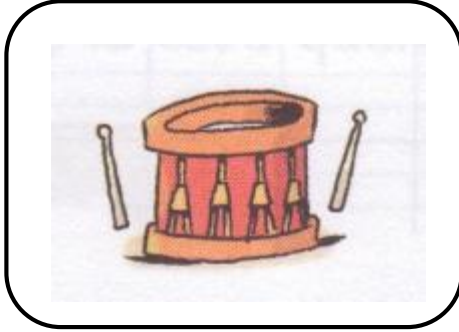
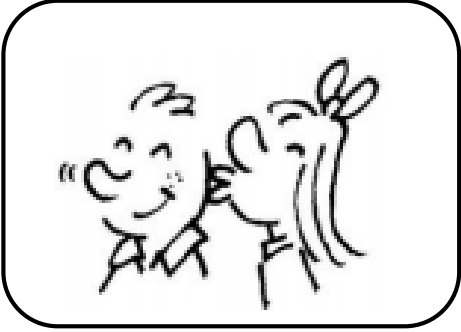

un jambon	des jambes	un pamplemousse	un timbre	embrasser
une lampe	un tambour	un concombre	une ampoule	



Date :

Prénom :



Ecris le mot correspondant à l'image.

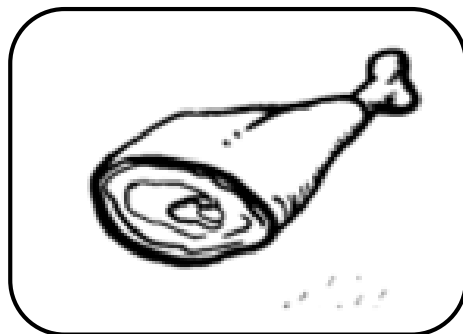
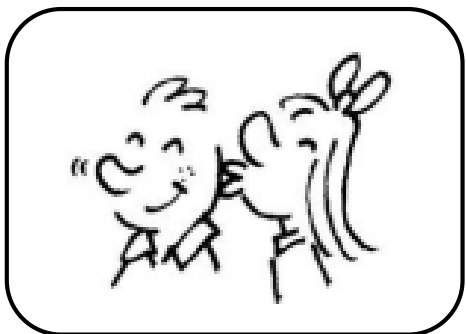

Handwriting practice grid with a blue dot on the top line.

Handwriting practice grid with a blue dot on the top line.

Handwriting practice grid with a blue dot on the top line.

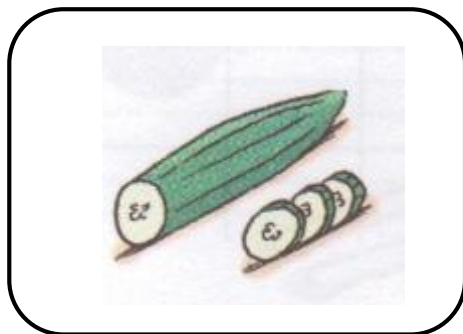
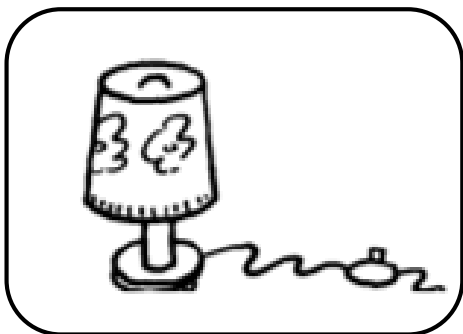
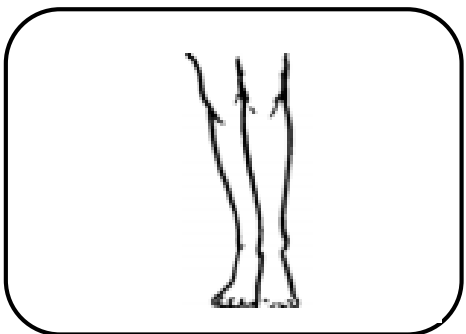

Handwriting practice grid with a blue dot on the top line.

Handwriting practice grid with a blue dot on the top line.

Handwriting practice grid with a blue dot on the top line.

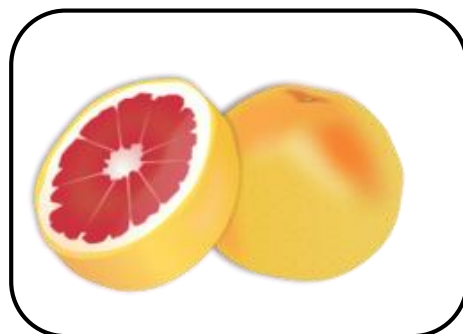
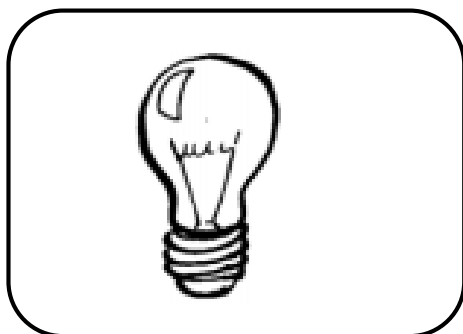

Handwriting practice grid with a blue dot on the top line.

Handwriting practice grid with a blue dot on the top line.

Handwriting practice grid with a blue dot on the top line.



Date :

Prénom :



Ecris le mot correspondant à l'image.

un jambon

une lampe

Des jambes

un tambour

un concombre

un pamplemousse

une ampoule

embrasser

un timbre

