

fichier lecture

direction Lima



Mon voyage lecture

Bienvenue à Panama

Bienvenue à Rio

Bienvenue à Lima

Letters: b, z, k, g, j, f, n, t, s, d, v

The graphic shows a path of letters: b, z, k, g, j, f, n, t, s, d, v. It includes an airport icon, a suitcase, a globe, and photos of Panama (beach), Rio (Christ the Redeemer), and Lima (cathedral). A dotted line from the title 'direction Lima' leads to the 'v' letter and the Lima photo.

Je découvre les sons [d] / [v]

dD
d D

un dauphin

vV
v V

la vache



1- Je lis une phrase

Marie part à Lima  papa.
avec

2- Je lis les mots outils.

un — une — des — les — est — et

3- J'écris des syllabes

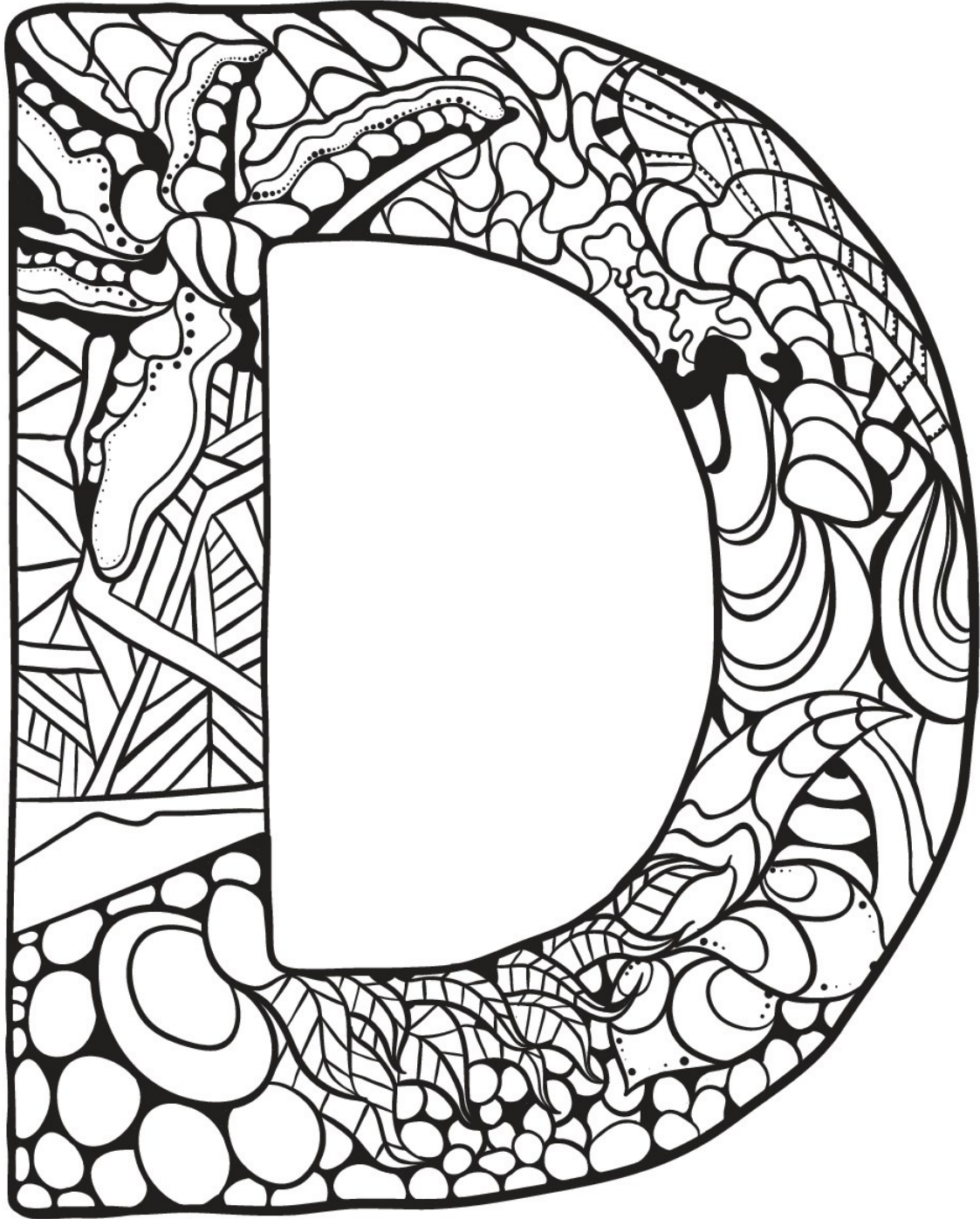

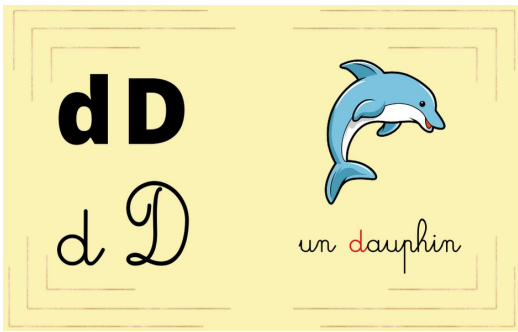

1- Je prononce des mots avec le son [d]



2- Je lis les syllabes

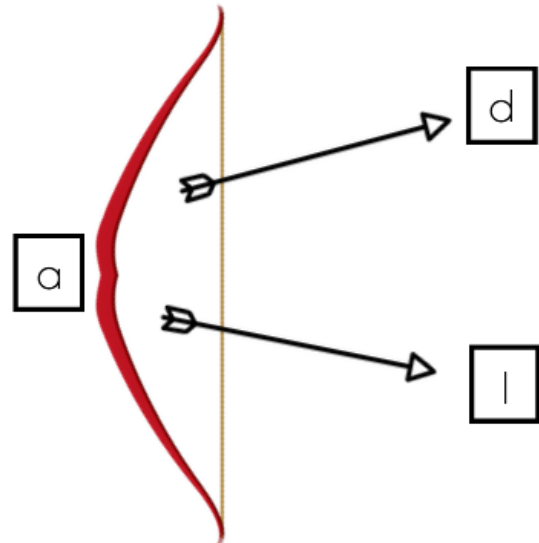
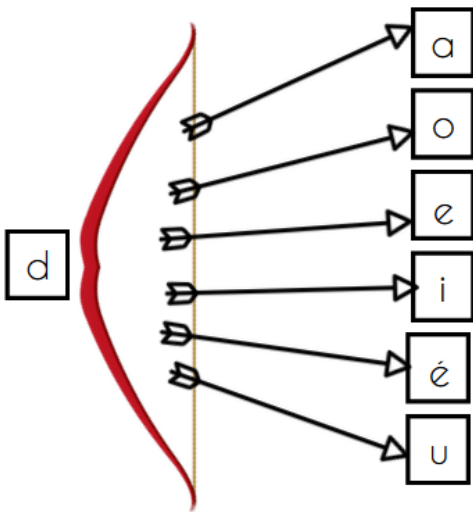

3- Je lis les mots outils.



une - des - est - une - les - et

Utilis au quotidien



1- Je lis des phrases

A Lima, Marie a un ami: Paolo.

Paolo est sur le dos du Lama.

2- Je lis les mots outils.

une - des - est - un - les - et - sur

3- J'écris des syllabes

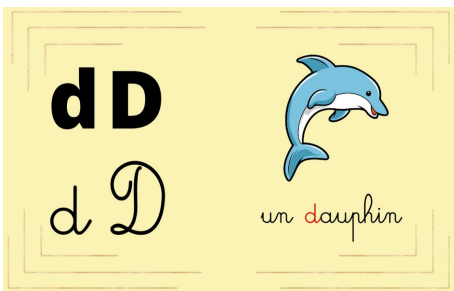

1- Je lis des syllabes :

d	de	di	do	dé	da
pa	re	li	mé	po	ru
la	mi	ro	lo	mu	ré
pi	lé	ap	ré	mo	ri

2- Je lis des mots:

Il dort	une dame	le radis	Une pédale
---------	----------	----------	------------

3- Je lis les mots outils.

une - est - des - un - les - sur - et

Colorie l'image de la bonne couleur

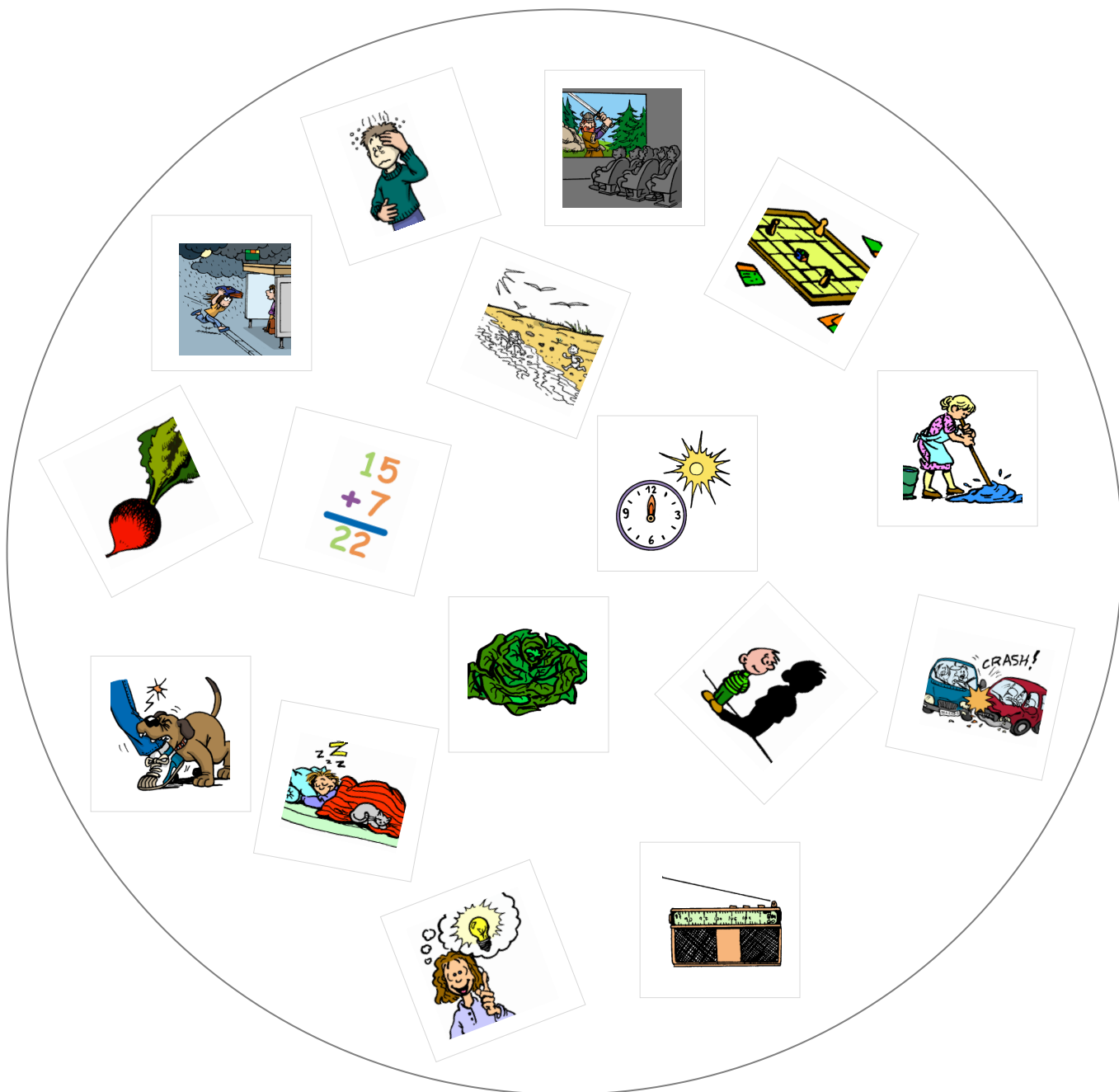

la radis

midi

dormir

la radio

malade





1- Je lis une phrase

Arima est à Lima. Il a pris un  du Mali.
avion







2- Je révise les mots outils.

et - sur - des - les- une - est - un

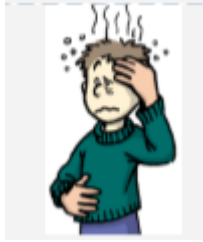
3- J'écris des syllabes

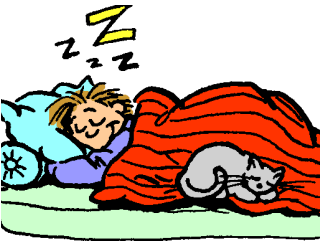
Utilis au quotidien

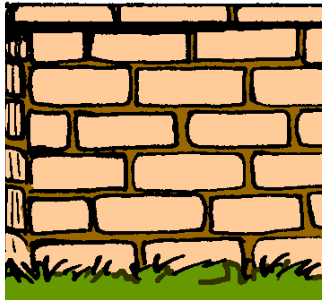

Découpe les mots et colle les en-dessous des images correspondantes.

Un radis	Le mur	Le dos
dormir	malade	rapide
lire	La radio	midi



1- Je lis des phrases

A Lima, il y a un lama  des  .
avec lunettes.

Paolo et Arima rient .



2- Je lis les mots outils.

une - est - et - des - sur - les - un

3- J'écris des syllabes

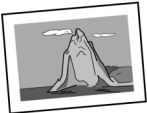

1- Je lis des phrases

Arima  montre la  photo du lama à Marie,  elle rit .

2- Je lis les mots outils.

une - est - et - des - sur - les - un

3- J'écris des syllabes

1- Je lis une phrase



Pédro le lama part de Lima, il part à Piura  des amis.
voir

2- Je lis des mots outils.

une - est - et - des - sur - les - un

3- J'écris des syllabes





1- Je prononce des mots avec le son [v]



2- Je lis les syllabes

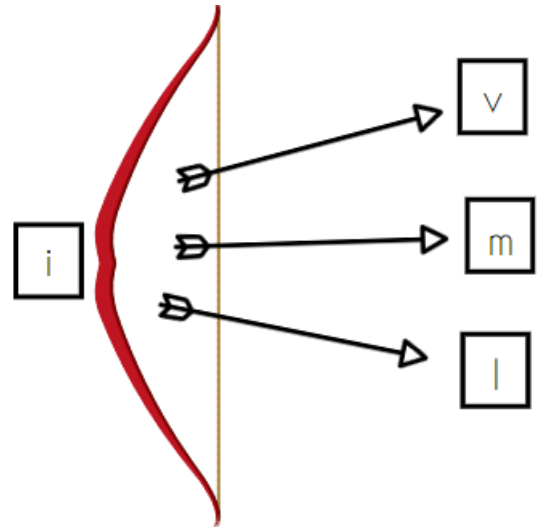
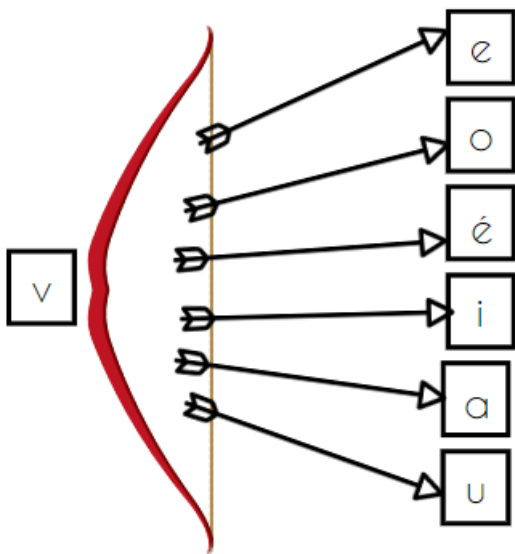

3- Je révise les mots outils.

un - une - est - des - sur - les - et





1- Je lis une phrase

Pédro est l'ami de Omar et Valéria. Omar et Valéria
vivent à Piura

2- Je lis les mots outils.

une - c'est - et - les - sur - est- un - des

3- J'écris des syllabes



1- Je lis des syllabes :

v	ve	va	vu	vo	vé
ma	le	ro	pu	da	vo
mo	vi	lu	ra	pe	do
vu	me	la	ve	ru	pé

2- Je lis des mots:

il vole	il lave	vide	un pavé
---------	---------	------	---------

3- Je lis les mots outils.

et - une - c'est - des - les - sur - est- un -



Entoure l'image de la bonne couleur

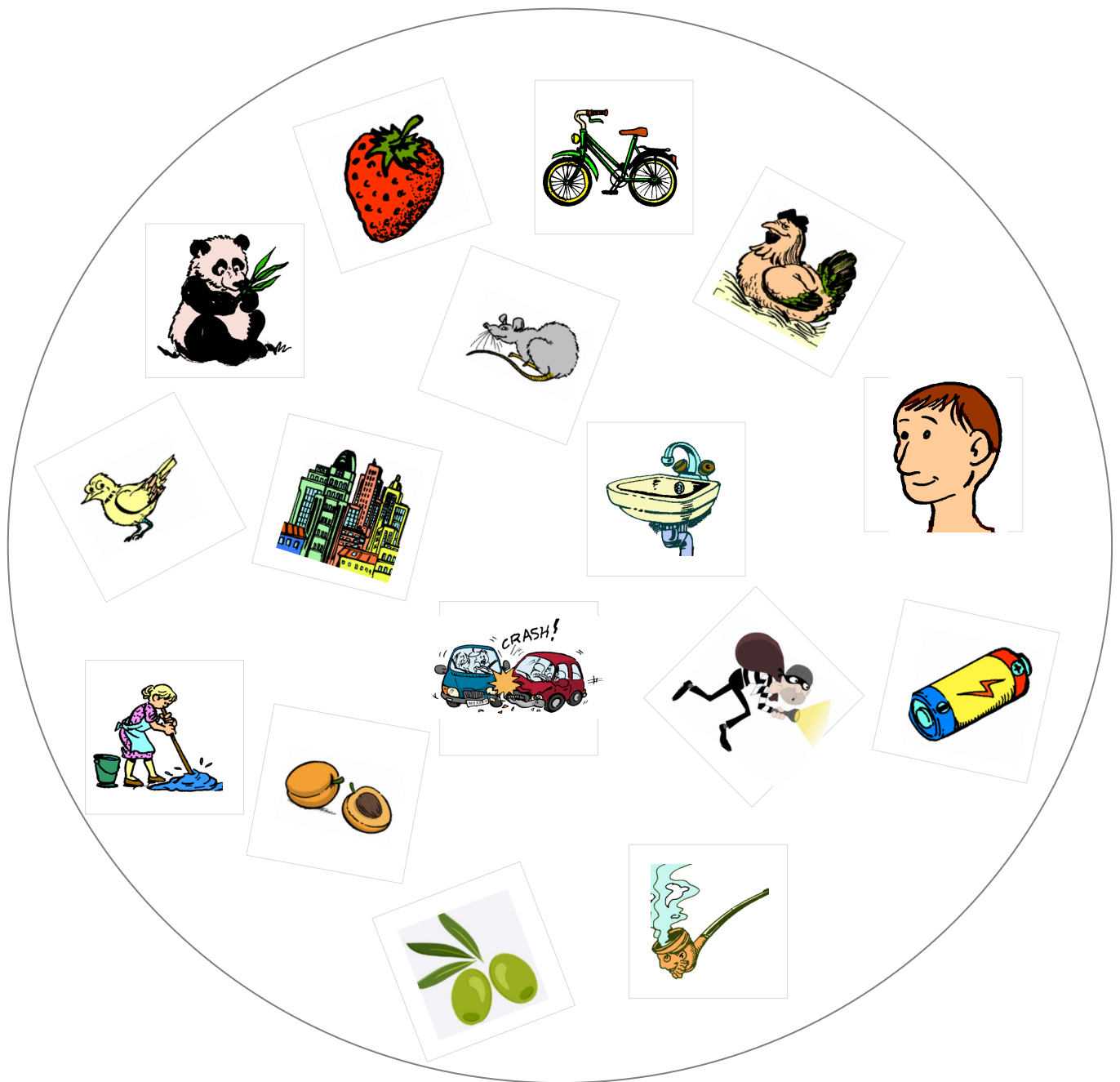

le vélo

une olive

une ville

La pipe

il vole





souvenirs de Piura

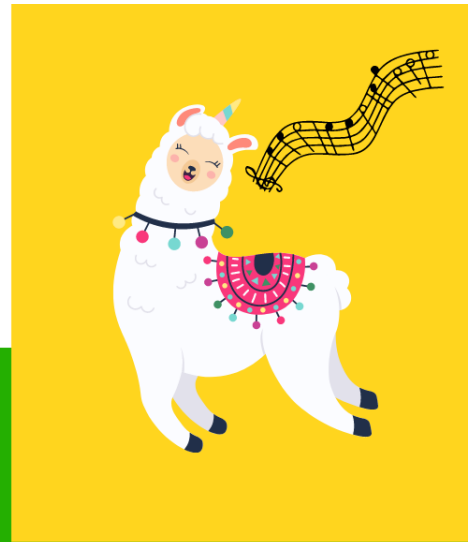

2- Je lis une phrase

A Piura, Pédro rit, il



, il prie. Il est drôle Pédro!

danse

2- Je lis les mots outils.

est- une - sur - c'est - et - les - un - des

3- J'écris des syllabes

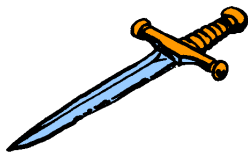
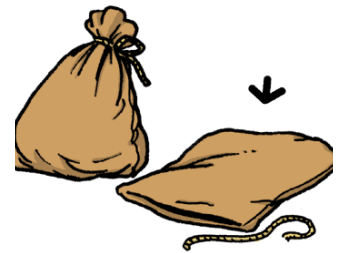

La ville

Une pile

il lave

Un vélo

Un livre

Une épée

il vole.

vide

Une momie



1- Je lis une phrase

Pédro dort, il  rêve.  Dans le  il vole.

2- Je lis les mots outils.

c'est - sur - une - et - des - les - est- un

3- J'écris des syllabes



1- Je lis une phrase

Mardi, Pédro part de Piura. Il repart à Lima  Liro le

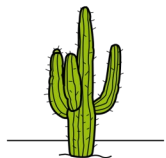

de Valéria sur le dos.

avec

cactus

2- Je révise les mots outils.

les - sur - une - c'est - des - et - est- un

3- J'écris des syllabes



DEPARTURES

TERMINAL B

TIME	DESTINATION	FLIGHT	BOARDING	GATE
14:45	BERLIN	LH2809	14:10	M23
15:00	LONDON	BD9502	14:30	M35
15:20	BUCHAREST	LY4481	14:50	A09
15:50	BEIJING	TK1627	15:20	D17
16:05	PARIS	RZ1485	15:35	E03
16:25	TOKYO	KL9005	16:00	C28
16:40	BARCELONA	MY2009	16:10	N15
17:00	LOS ANGELES	RL7775	16:30	M03
17:20	RIO DE JANEIRO	DH0914	16:50	R29

Bienvenue à Lima



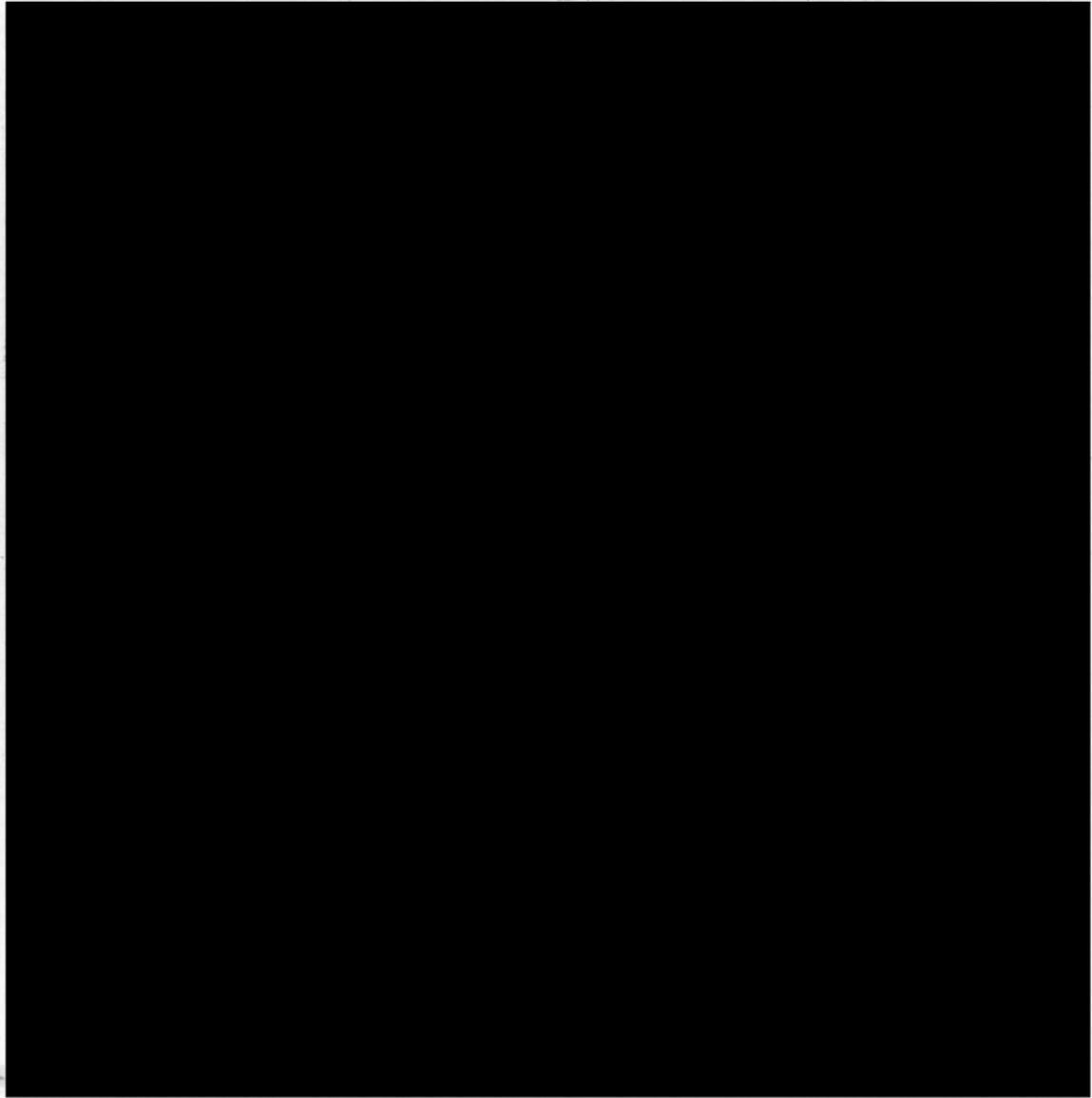

Je lis mon premier livre seul.

