

CP Vocabulaire autour de l'école et la rentrée

1. Entoure 9 les objets que l'on peut trouver à l'école:

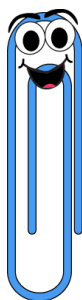

2. Découpe

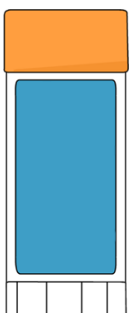
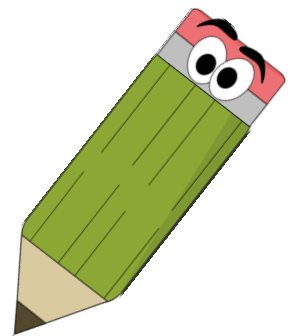
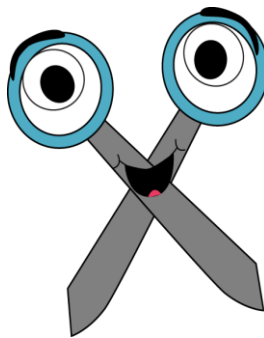
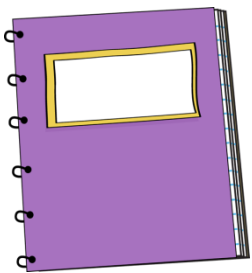
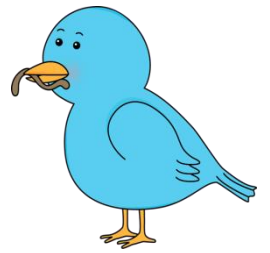
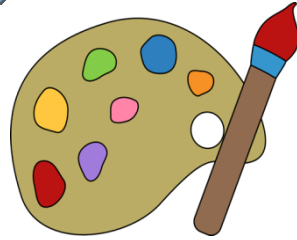
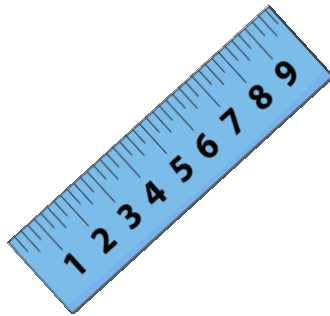
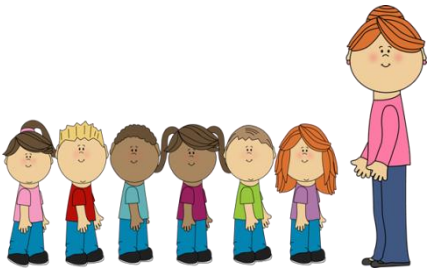
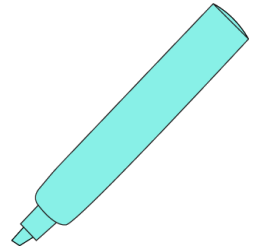
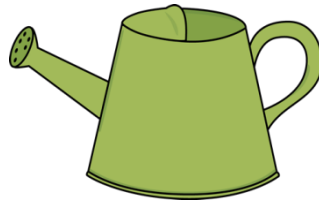
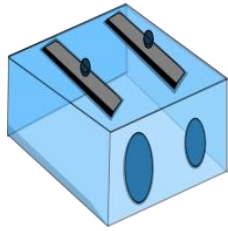
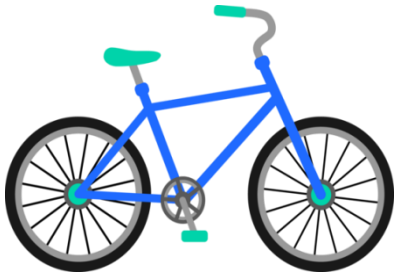

les étiquettes pour compléter la

trousse:

IL FAUT: un crayon de papier, de la colle, un stylo bleu et un stylo vert, une gomme, un fluo, un feutre velleda, un taille crayon

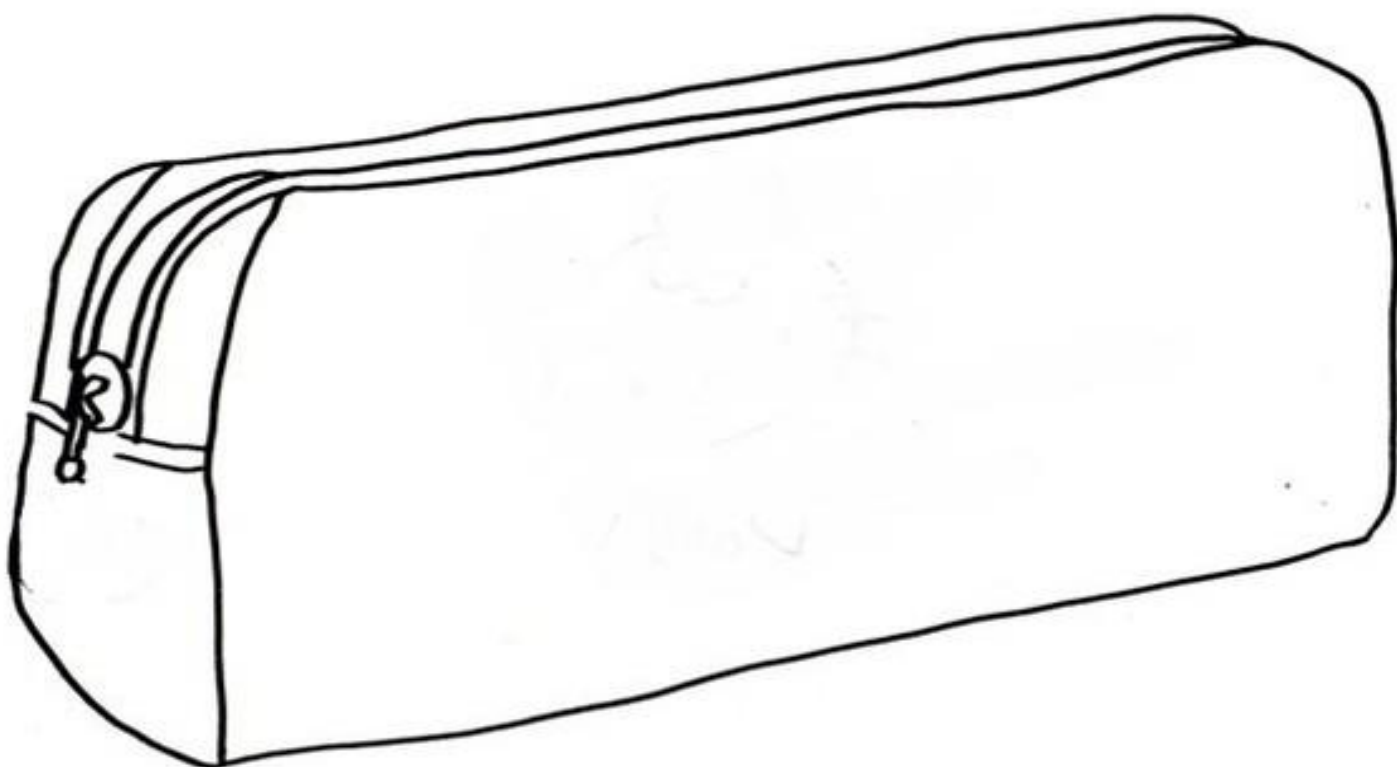

3. Colorie



les mots identiques de la même couleur.

ECOLE	trousse	classe
CARTABLE	stylo	rentrée
CLASSE	école	trousse
TROUSSE	rentrée	stylo
RENTREE	cartable	école
STYLO	classe	cartable

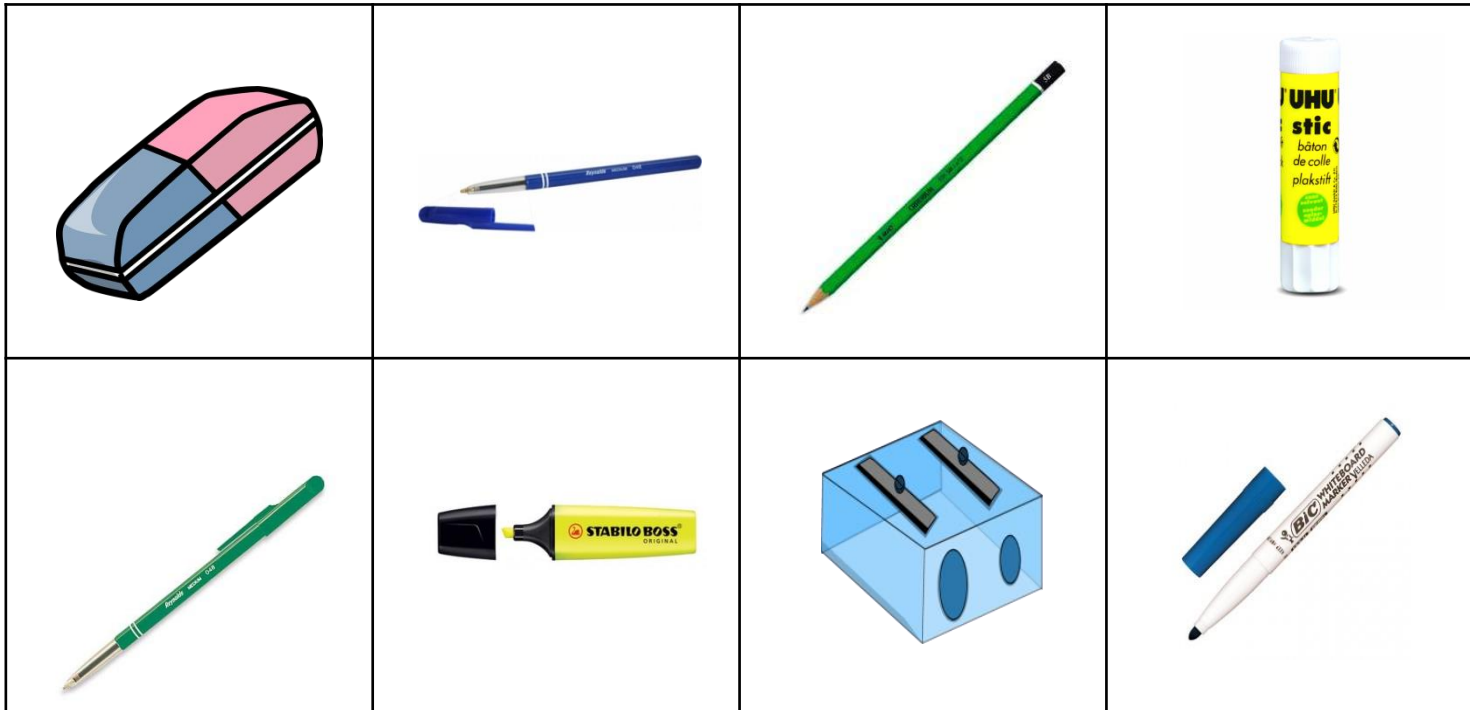
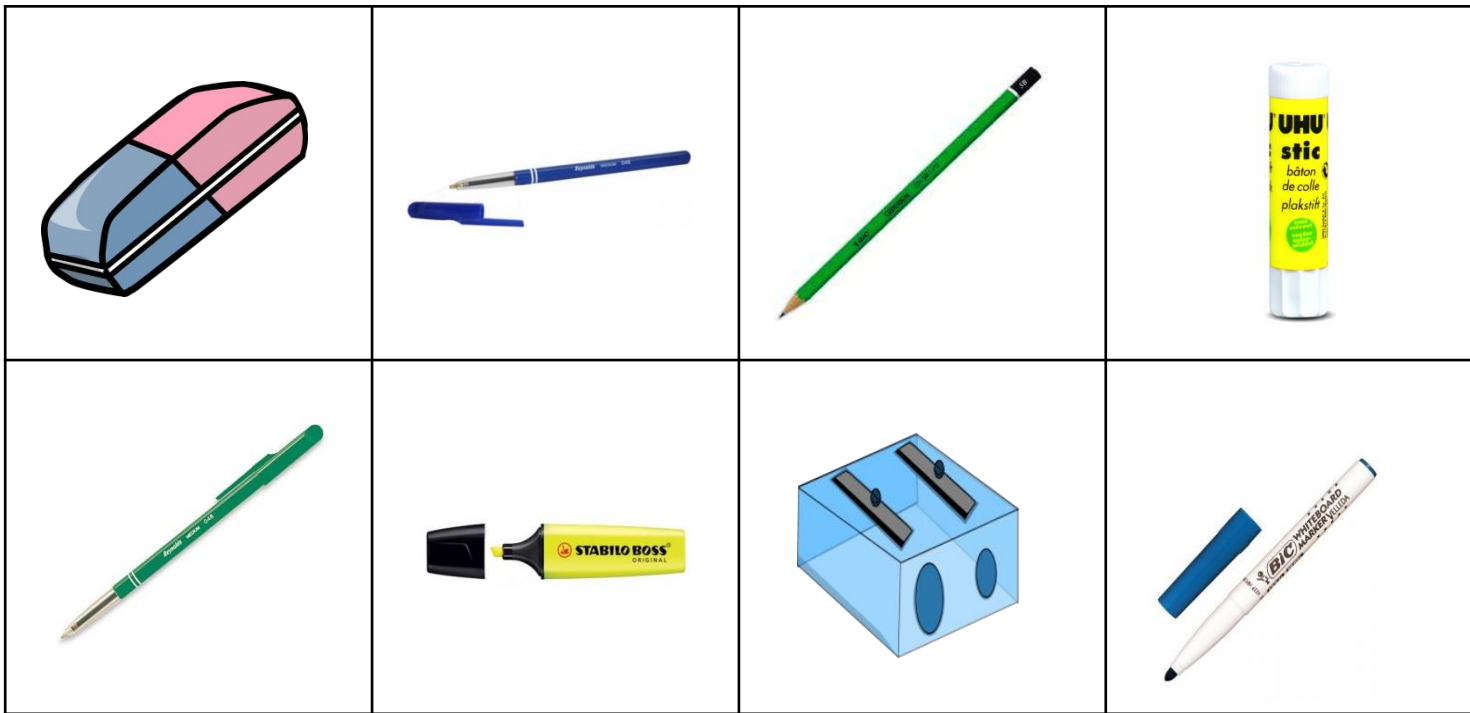
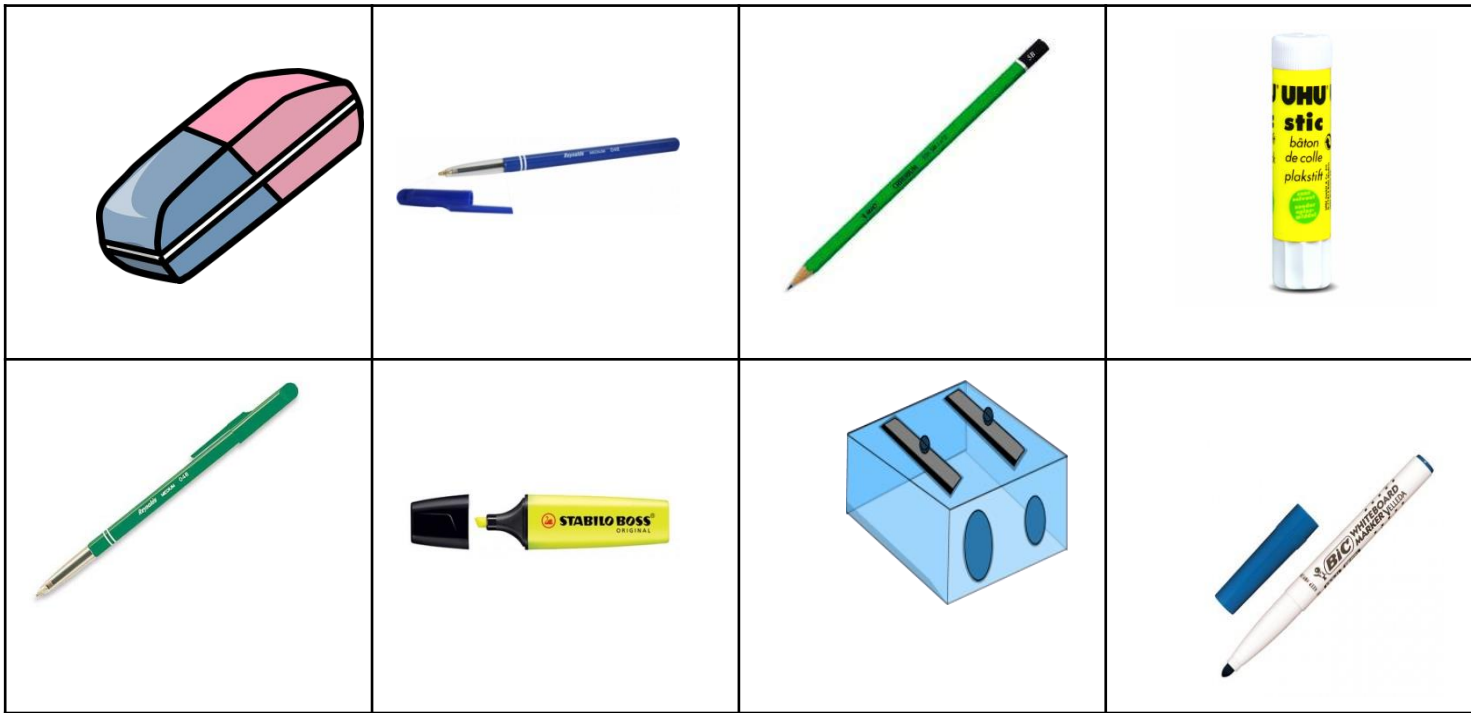

4. Relie  les mots identiques.

la maîtresse

le stylo

la classe

le cartable

le cartable

la rentrée

le stylo

le tableau

le tableau

la maîtresse

la rentrée

la classe

5. Complète  pour dire le nombre de lettres dans chaque mot

E C O L E



M A I T R E S S E



R E N T R E E



C L A S S E

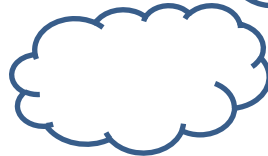

C A R T A B L E



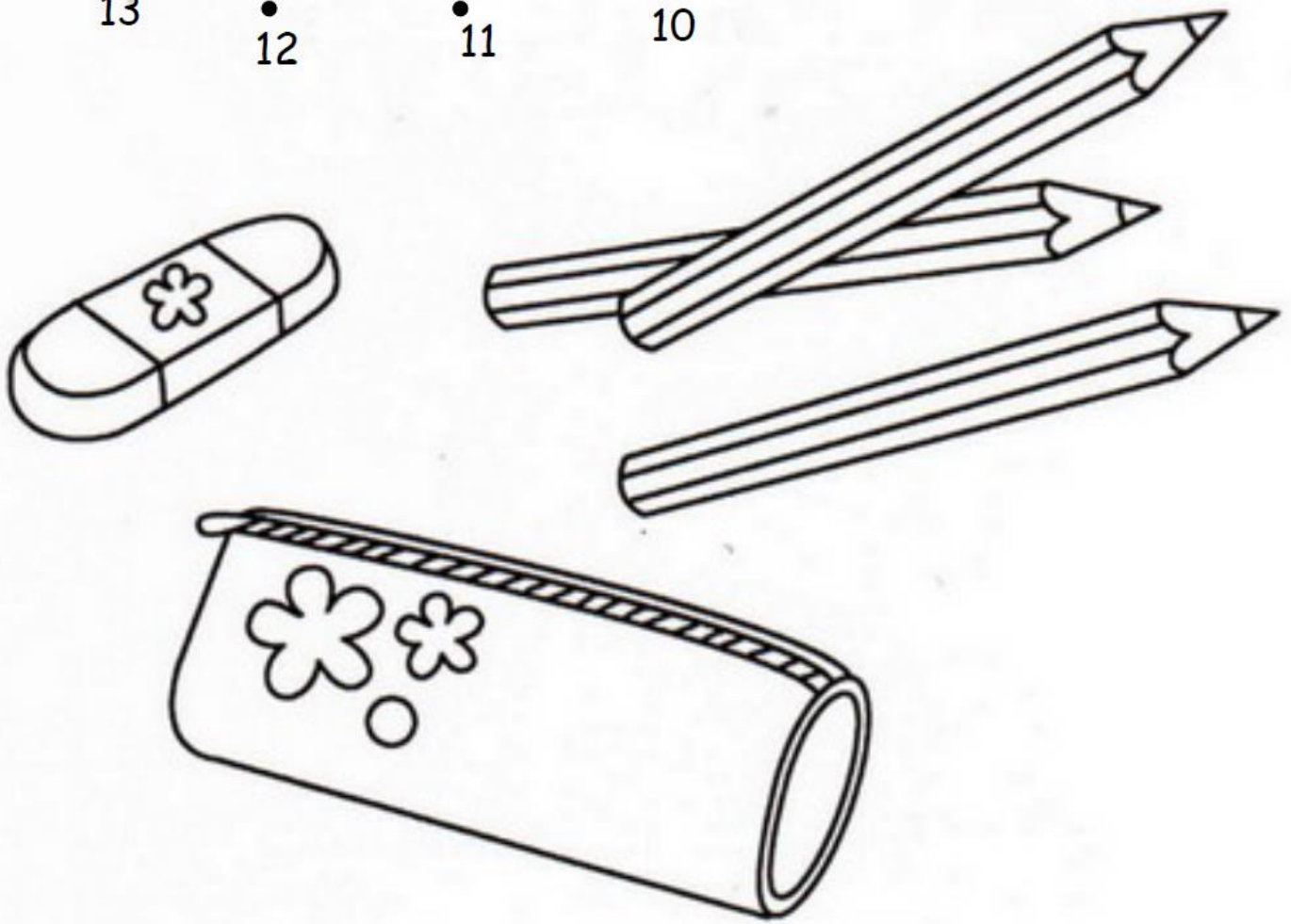
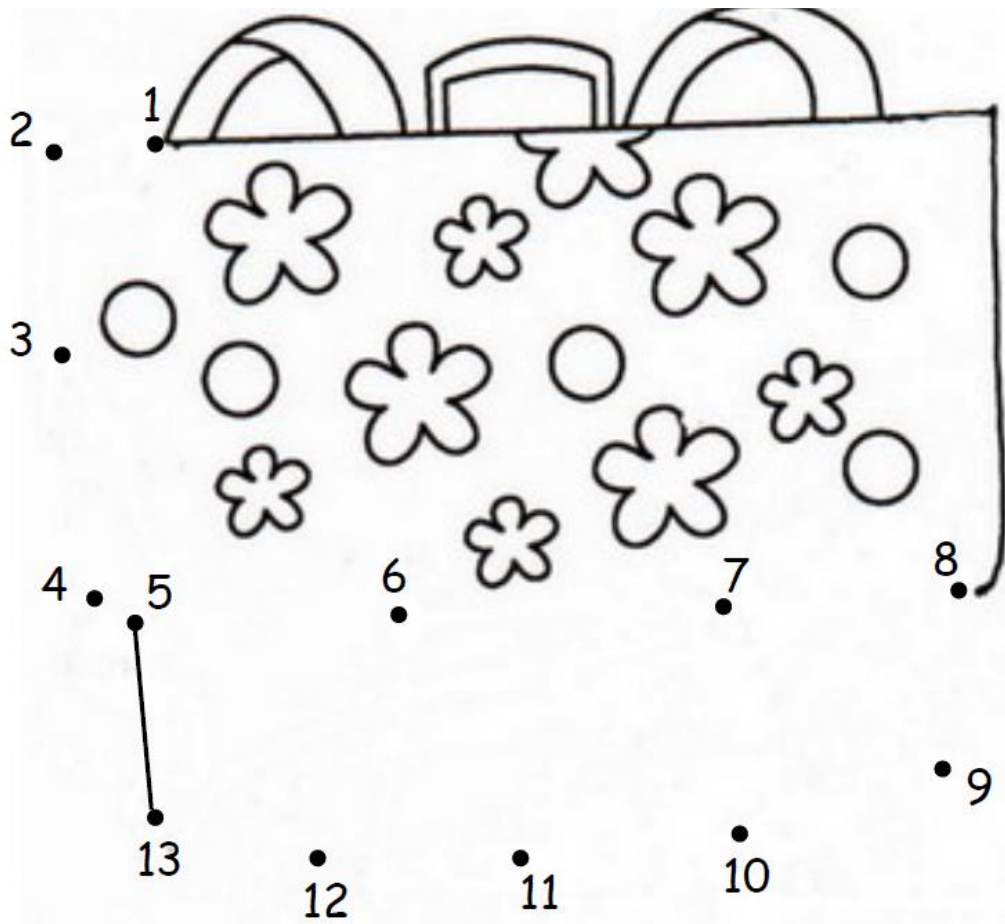

1	2	3	4	5	6	7	8	9	10	11	12	13
---	---	---	---	---	---	---	---	---	----	----	----	----

