

19

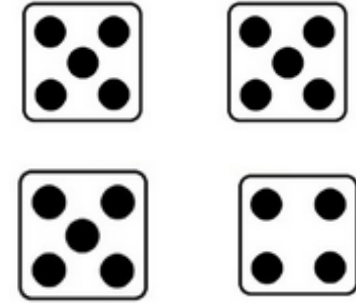
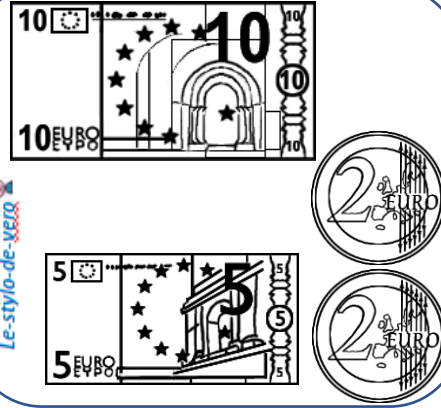
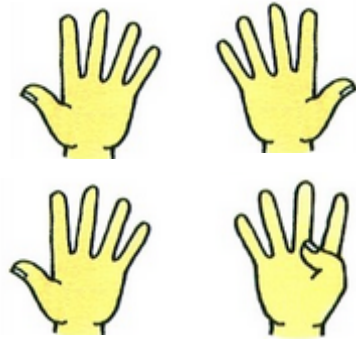

10 + 9

disc-neuf

5 + 5

disc

10

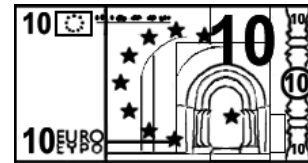
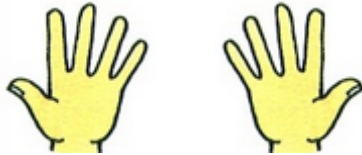

17

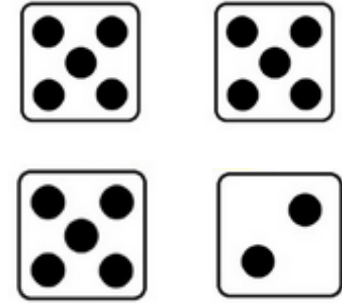
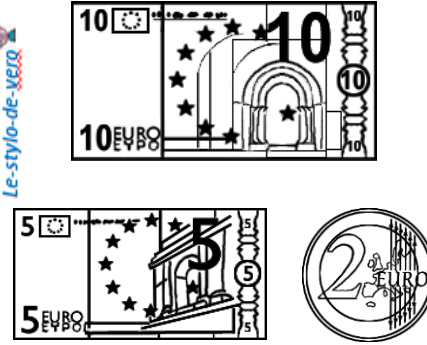
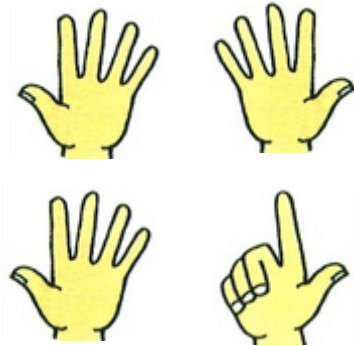

10 + 7

disc-sept

10 + 8

disc-huit

18

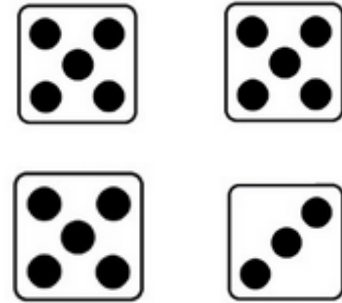
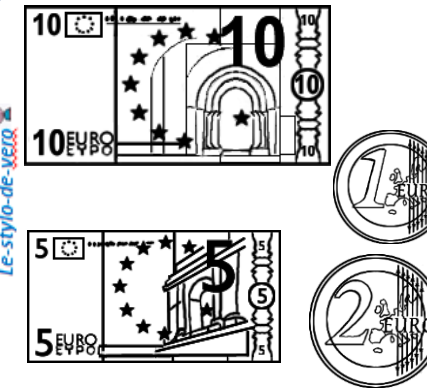
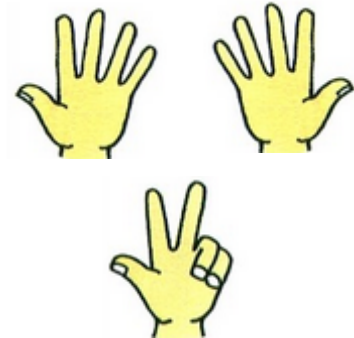

15

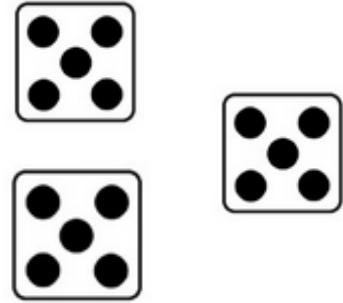
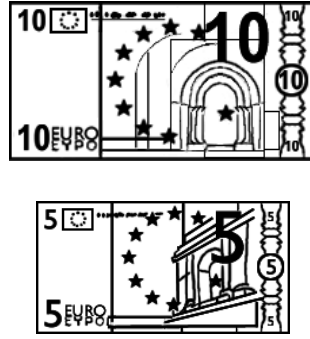
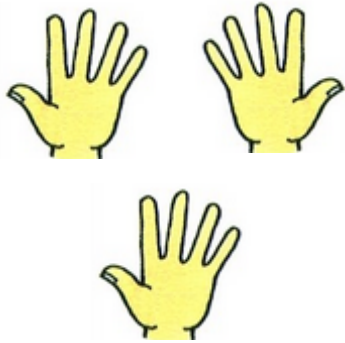

$10 + 5$

quinze

$10 + 6$

seize

16

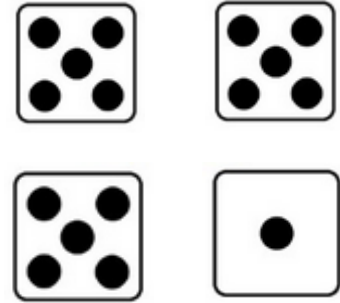
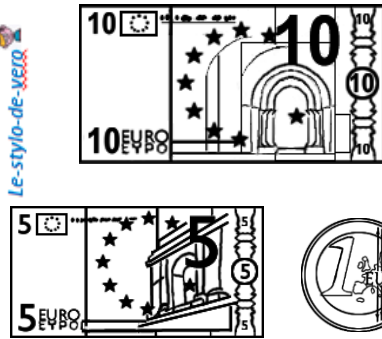
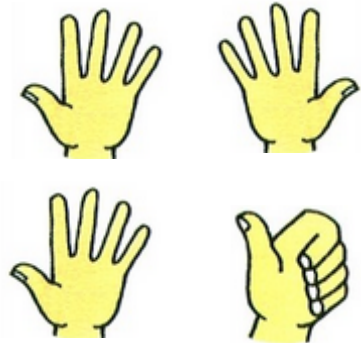

12

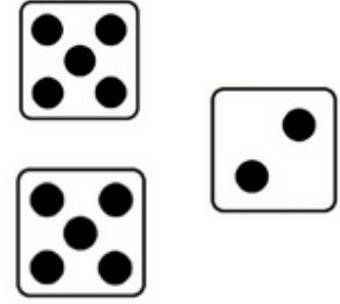
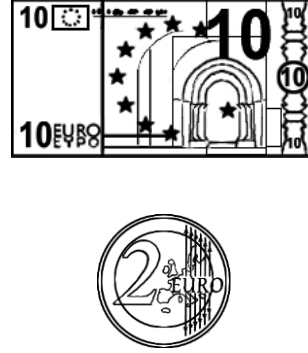
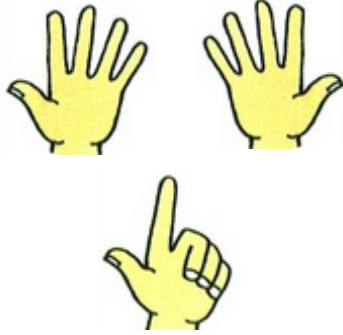

10 + 2

douze

10 + 1

onze

11

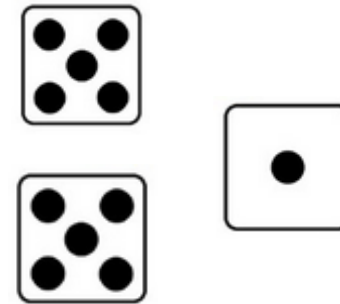
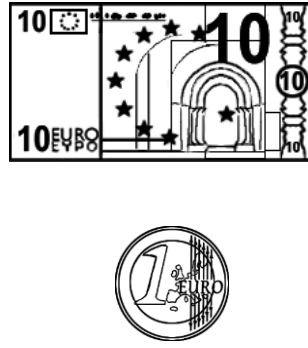
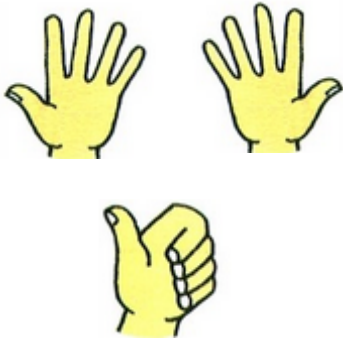

14

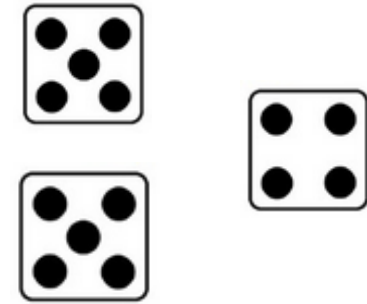
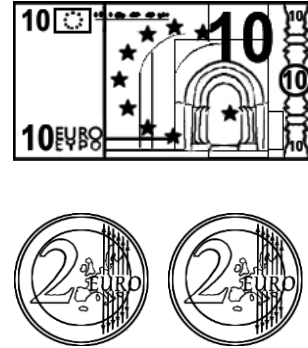
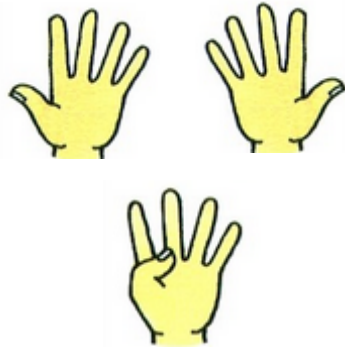

$10 + 4$

quatorze

$10 + 3$

treize

13

