

lettre

porte

guirlande

timbre

jouet(s)

sapin

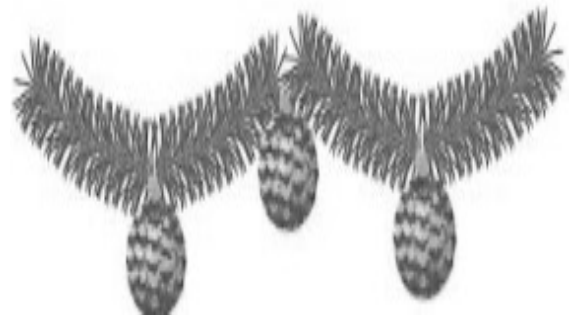

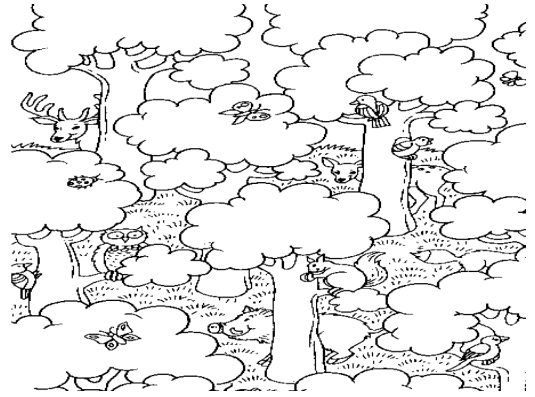

fille

école

forêt

cour  
récréation

docteur

panier

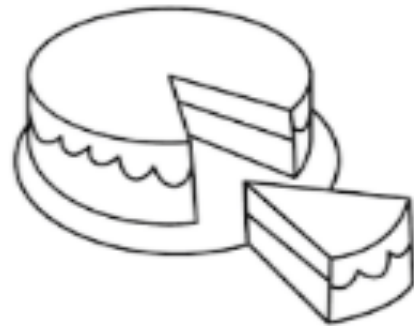
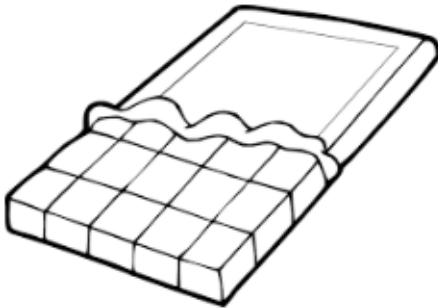
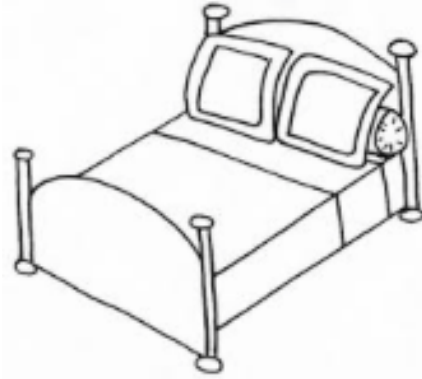

### Tarte aux pommes (sans beurre)

220g de farine  
1 œuf  
1 bonne cuillère à soupe de sucre  
4 cuillères à soupe d'huile d'olive  
50g de poudre d'amande

Mélanger tous les ingrédients ci-dessus pour faire la pâte, si elle est trop friable, ajouter un peu d'eau

Étaler la pâte au fond d'un moule à tarte

3

disposer les lamelles de pommes en sauce...

...sucrer, saupoudrer de cannelle puis enfourner pour 20 min à 180°C

Éplucher (ou peler) 4 belles pommes et les couper en lamelles puis en lamelles

disposer 2 à 3 cuillères à soupe de compote (en pot)



lit

maison

gâteau

chocolat

sorcière

recette



photo

vent

facteur

soldat

fève

couronne



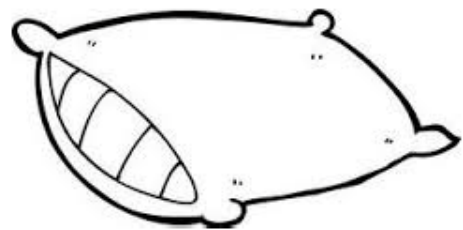
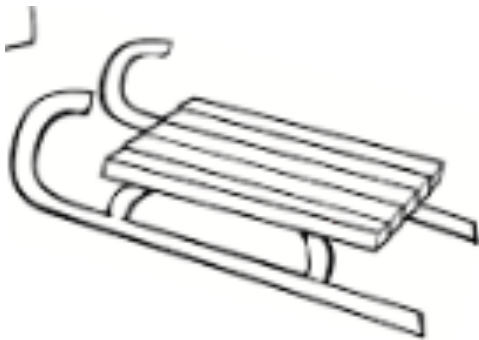
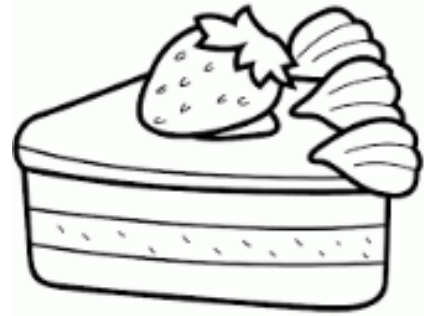

part

galette

dent

luge

oreiller

lait

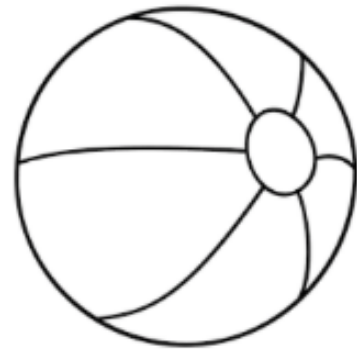
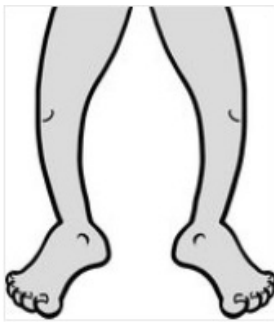

rêve

géant

fauteuil

bureau

ballon

jambe