

NOM :  
Prénom :  
Classe :

Exercice  
La cotation

CI 1 : Les techniques et outils de représentation du réel



**Consigne :** Déterminer en calculant les cotes manquantes sur les plans ci dessous afin que les perçages soient centrés sur les plaques.

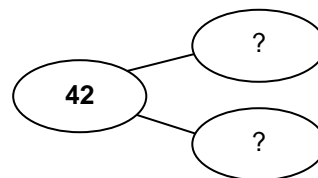
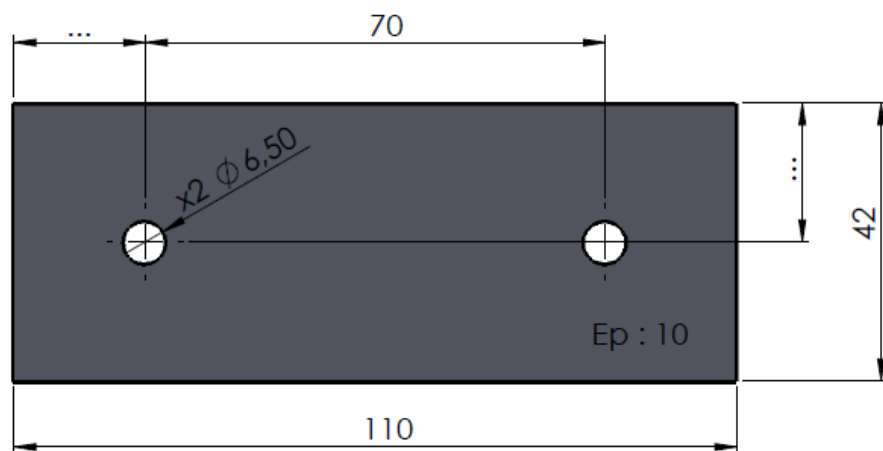

Calcul : .....  
.....  
.....

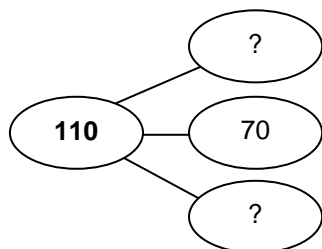

Calcul : .....  
.....  
.....  
.....

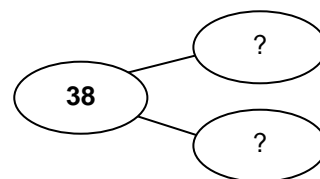
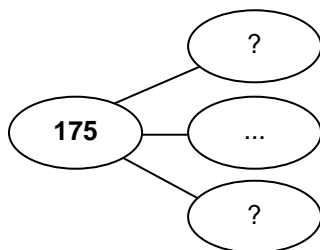
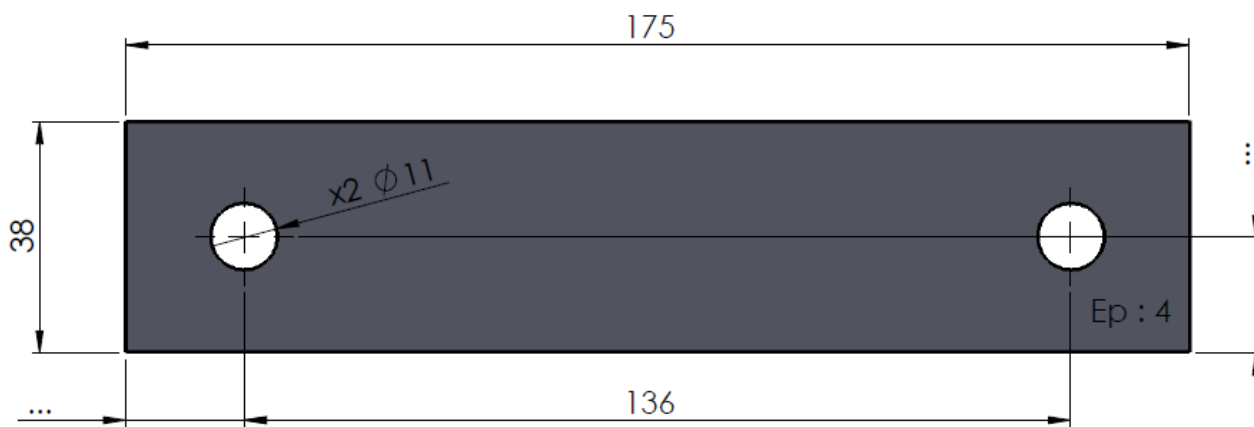

Calcul : .....  
.....  
.....

Calcul : .....  
.....  
.....

NOM :  
Prénom :  
Classe :

Exercice  
La cotation

CI 1 : Les techniques et outils de représentation du réel

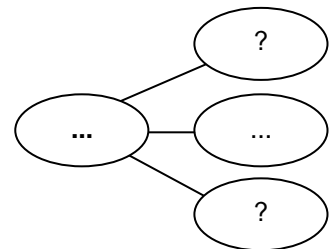
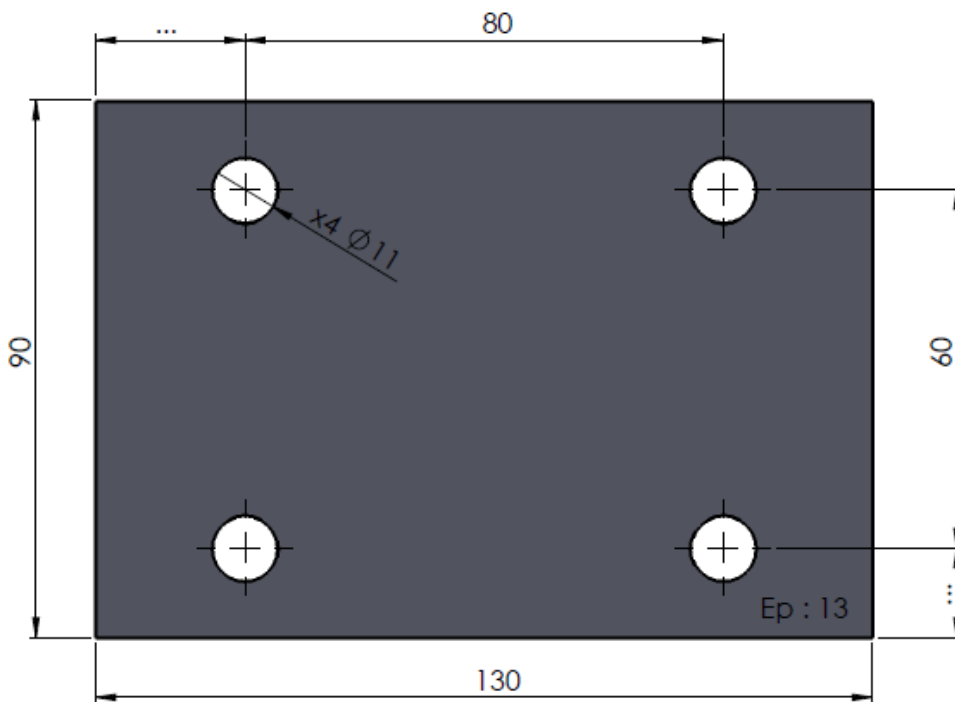
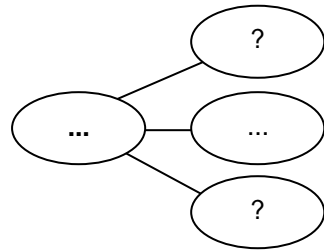
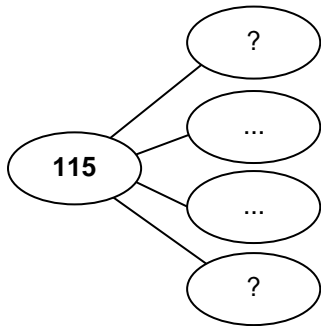
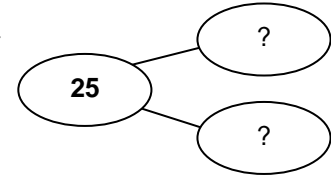
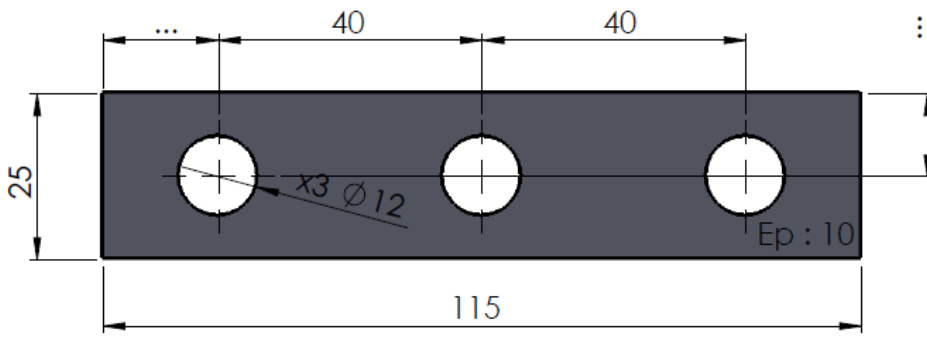

NOM :  
Prénom :  
Classe :

Exercice  
La cotation

CI 1 : Les techniques et outils de représentation du réel

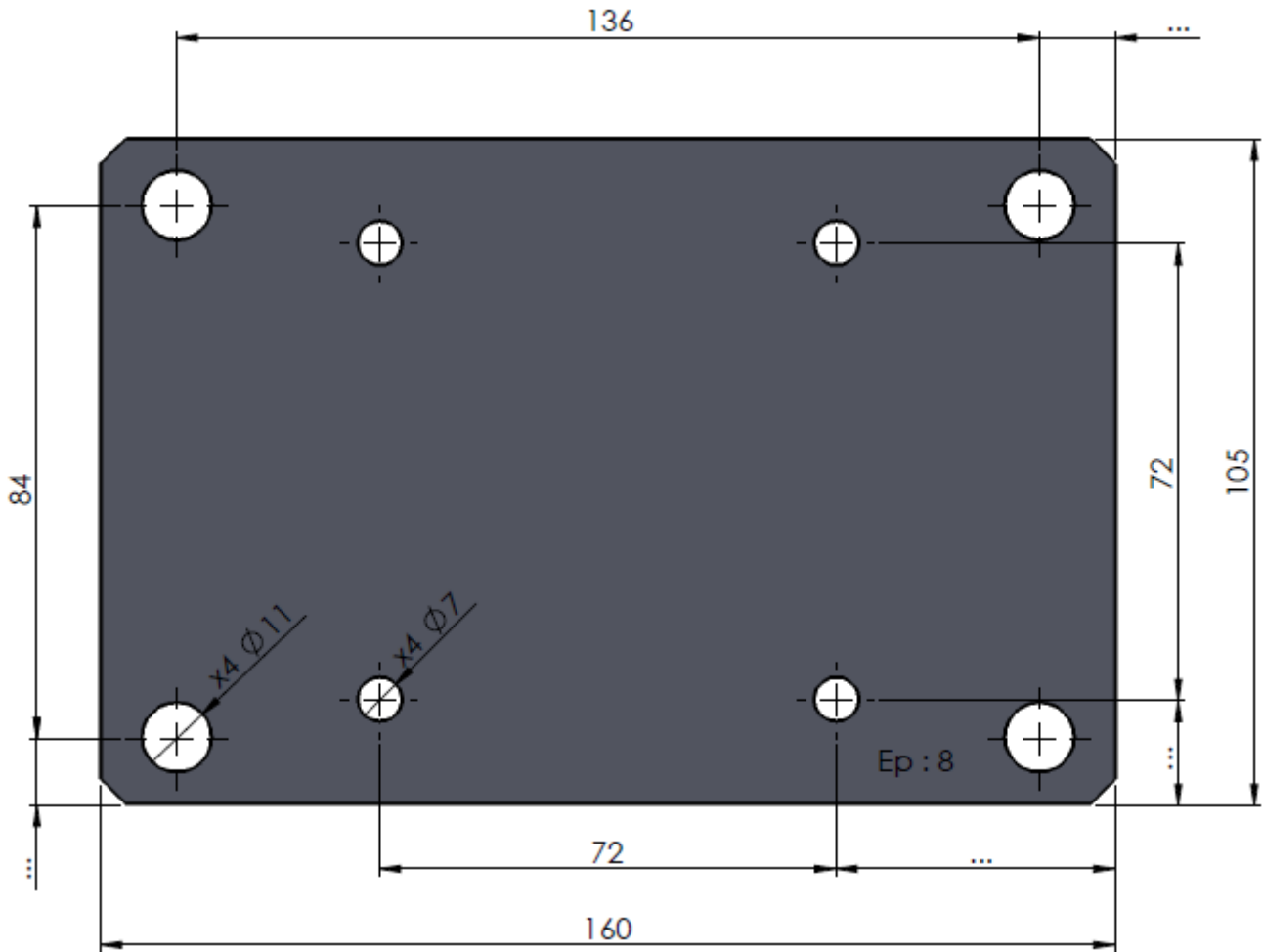

perçages diamètre 11

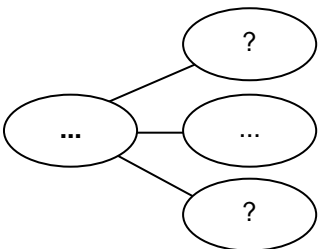
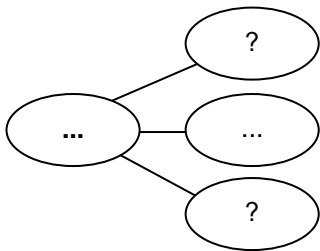

perçages diamètre 7

