

Mémo 15

étape 1

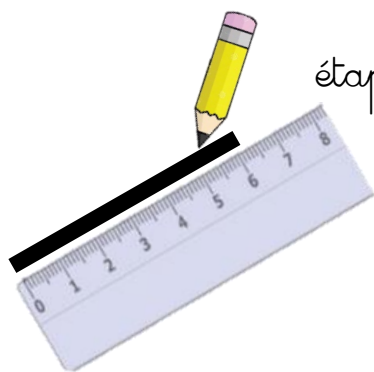

étape 2

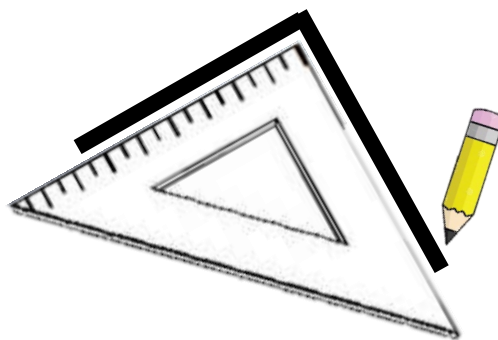

étape 3

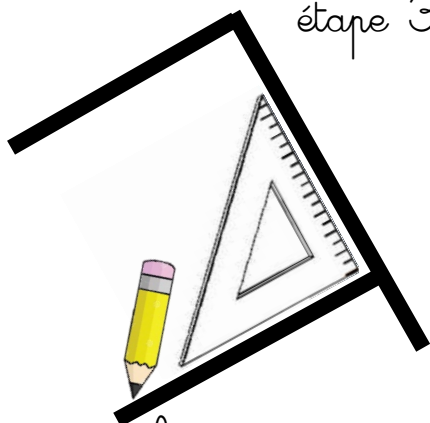

étape 4

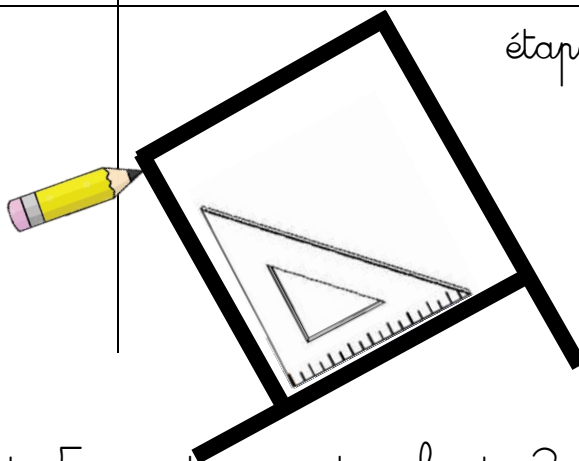

Sur ton cahier, trace un carré de 5 cm et un rectangle de 3 cm sur 5 cm.

Mémo 15

étape 1

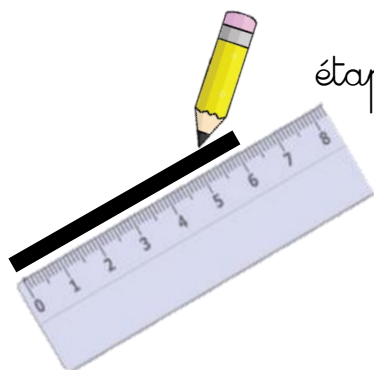

étape 2

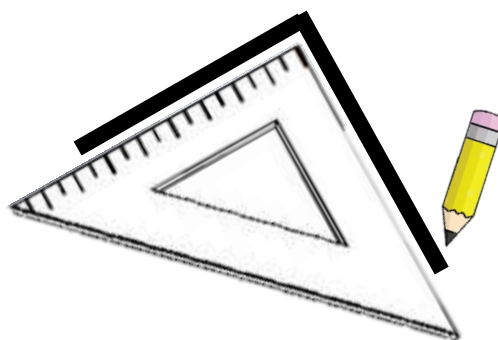

étape 3

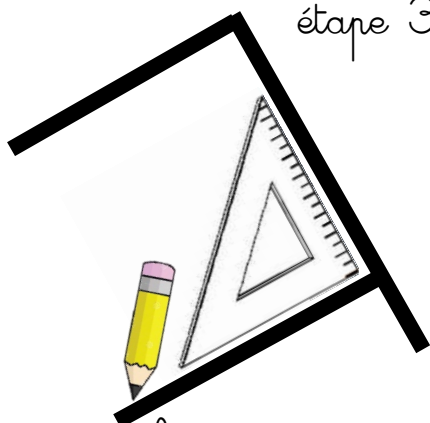

étape 4

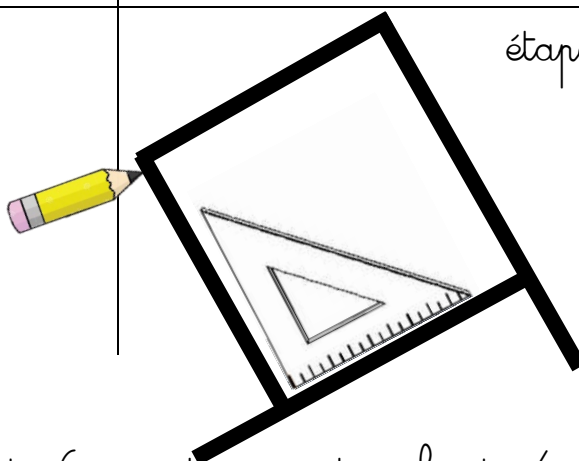

Sur ton cahier, trace un carré de 6 cm et un rectangle de 4 cm sur 6 cm.

Mémo 15

étape 1

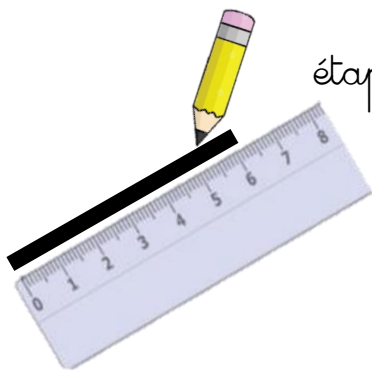

étape 2

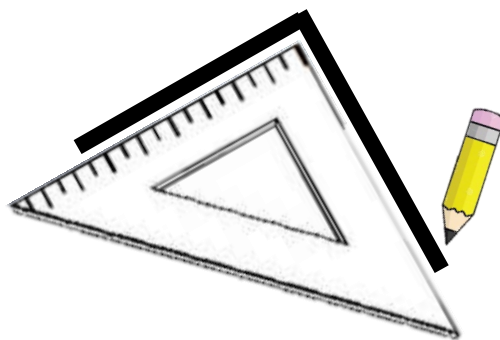

étape 3

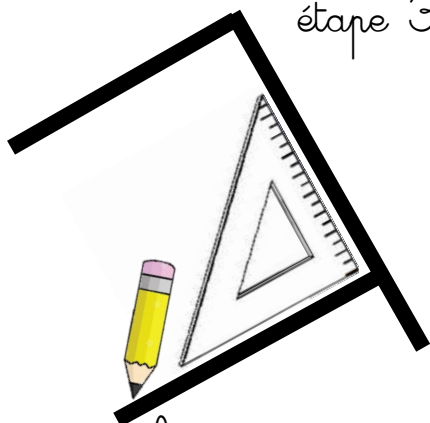

étape 4

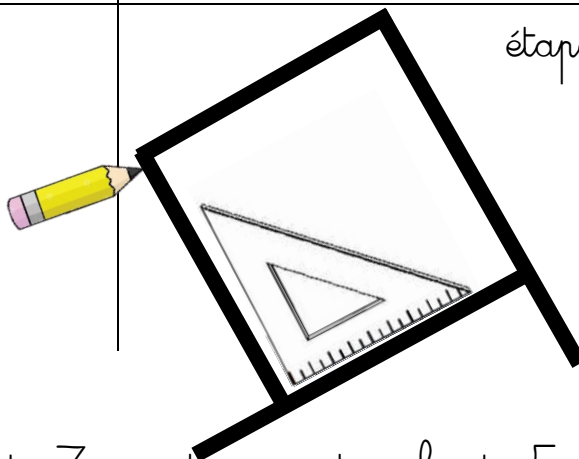

Sur ton cahier, trace un carré de 7 cm et un rectangle de 5 cm sur 7 cm.

Mémo 15

étape 1

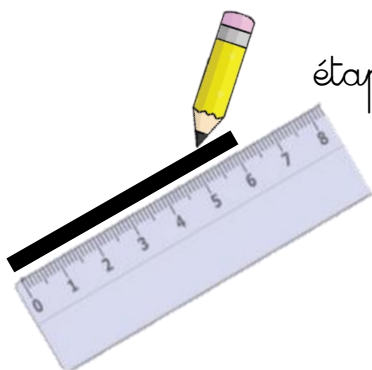

étape 2

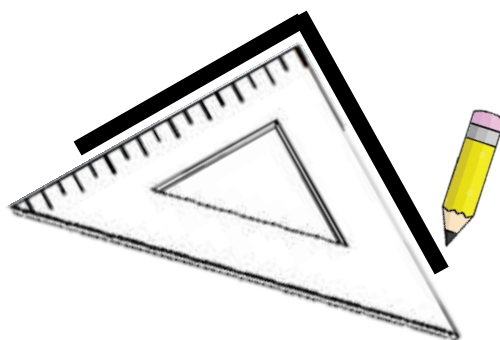

étape 3

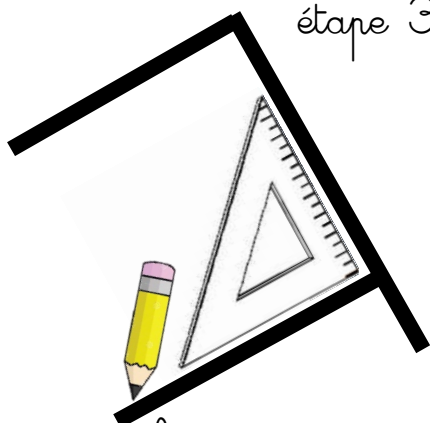

étape 4

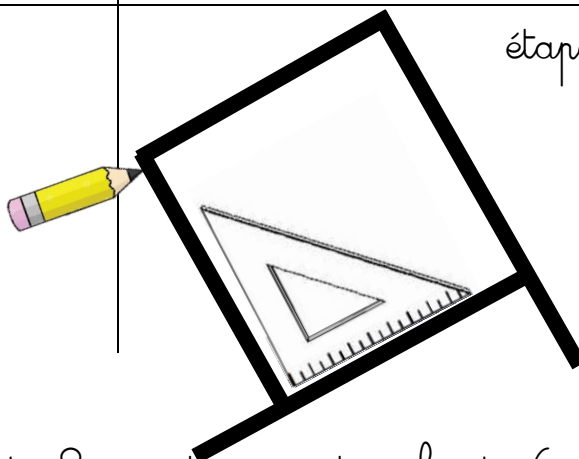

Sur ton cahier, trace un carré de 8 cm et un rectangle de 6 cm sur 8 cm.

Mémo 15

étape 1

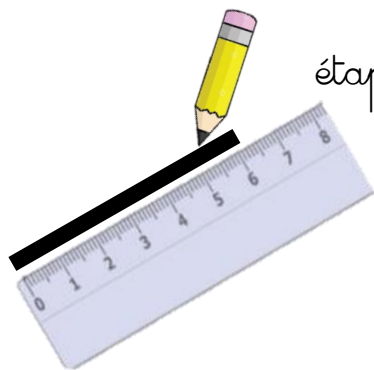

étape 2

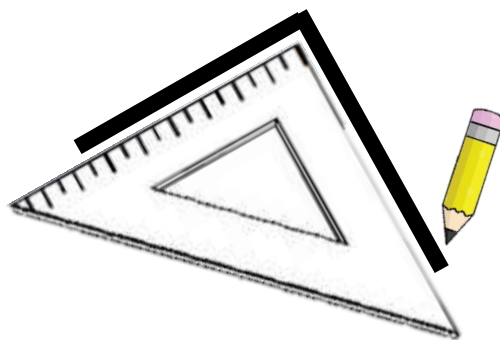

étape 3

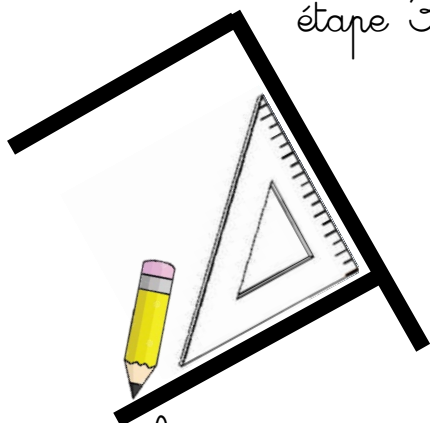

étape 4

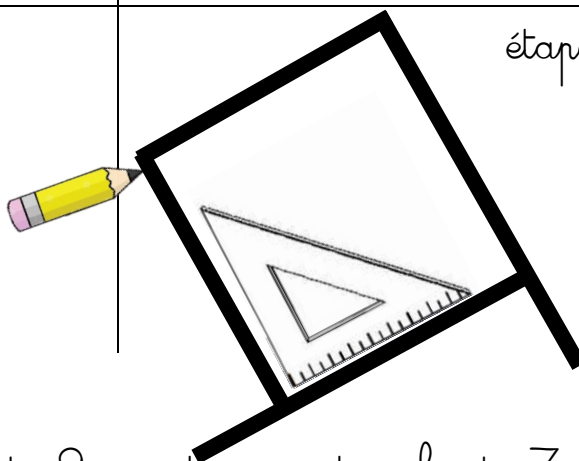

Sur ton cahier, trace un carré de 9 cm et un rectangle de 7 cm sur 9 cm.

Mémo 15

étape 1

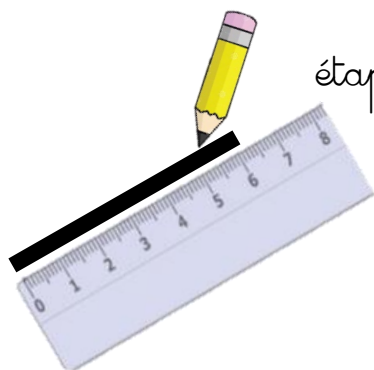

étape 2

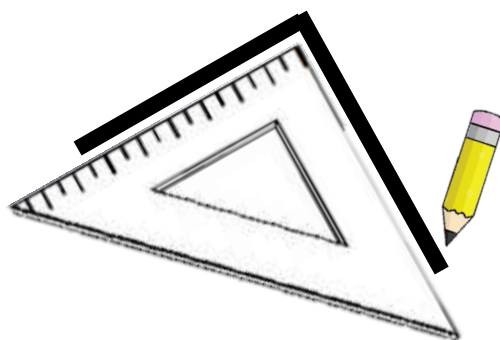

étape 3

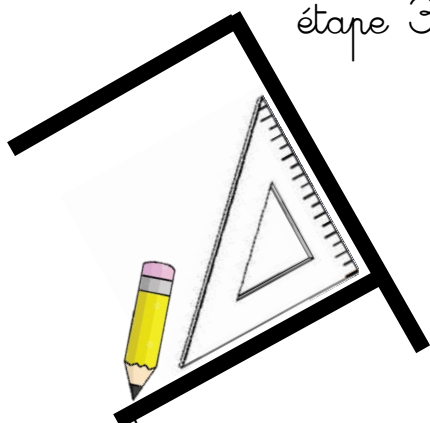

étape 4

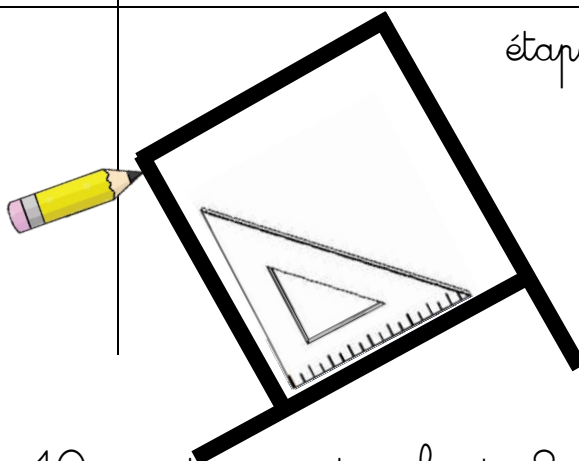

Sur ton cahier, trace un carré de 10 cm et un rectangle de 8 cm sur 10 cm.

Mémo 15

étape 1

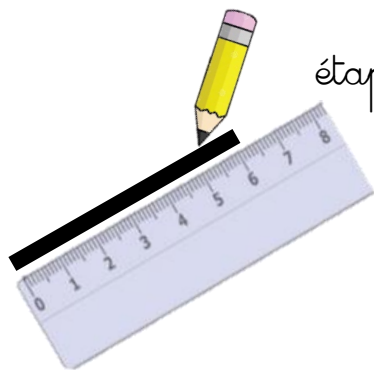

étape 2

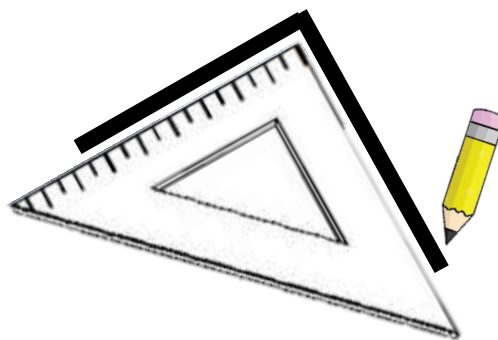

étape 3

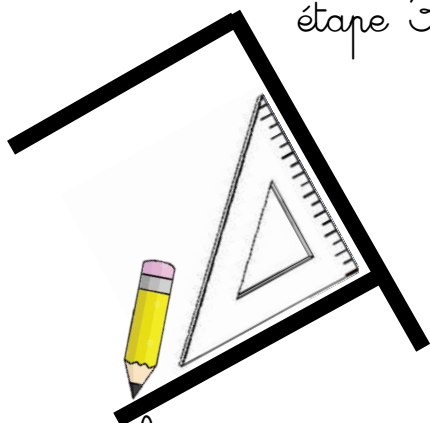

étape 4

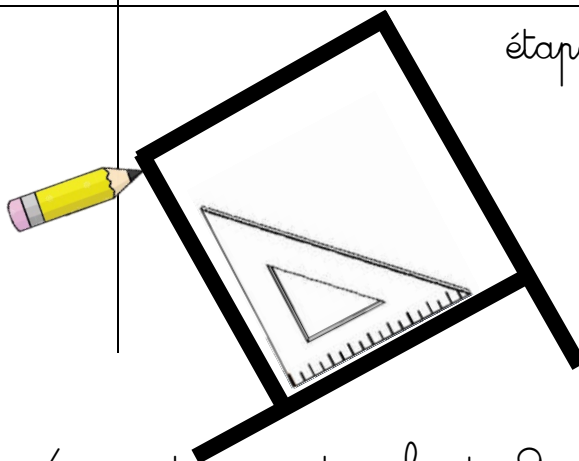

Pur ton cahier, trace un carré de 4 cm et un rectangle de 9 cm sur 11 cm.

Mémo 15

étape 1

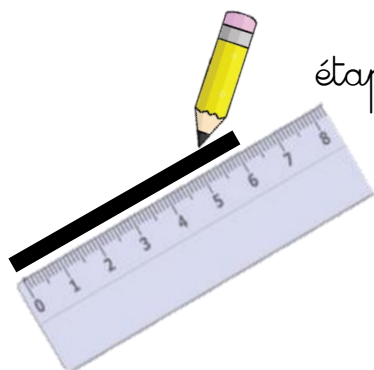

étape 2

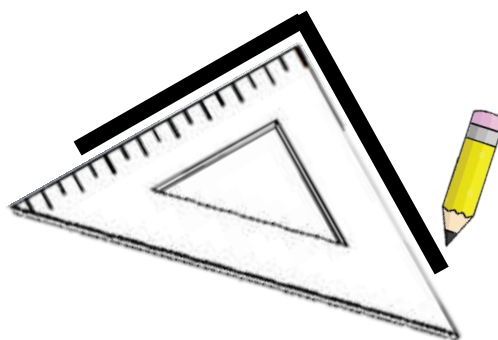

étape 3

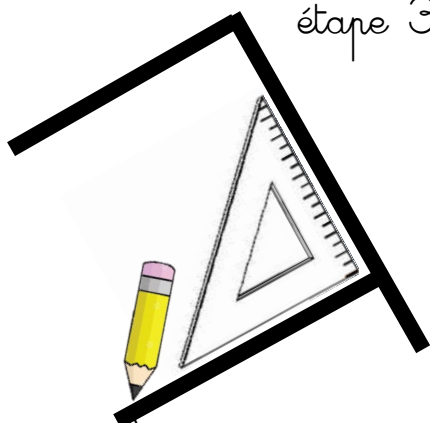

étape 4

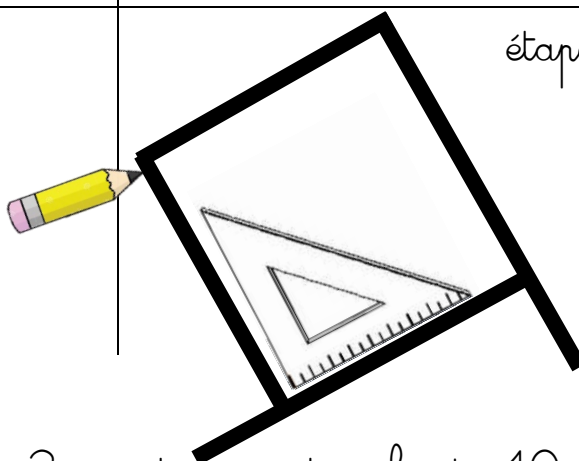

Pur ton cahier, trace un carré de 3 cm et un rectangle de 10 cm sur 12 cm.

ÉVALUATION CE2 GEOM7

Compétence : Tracer des carrés et des rectangles en utilisant la règle et l'équerre.

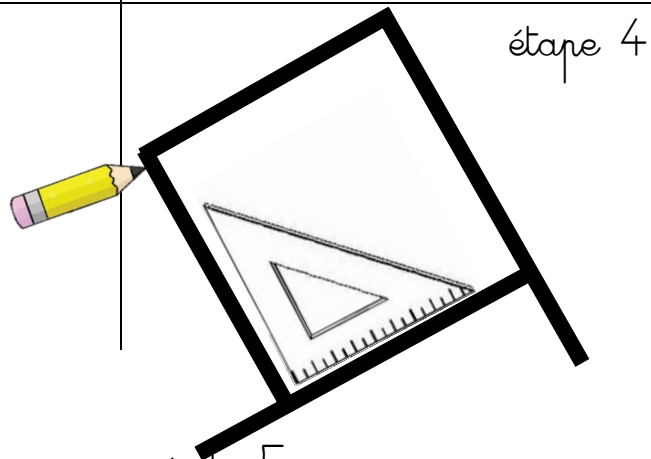
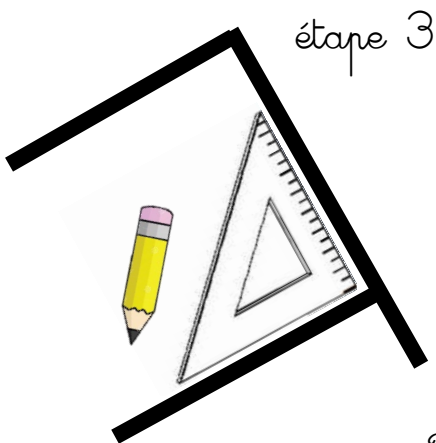
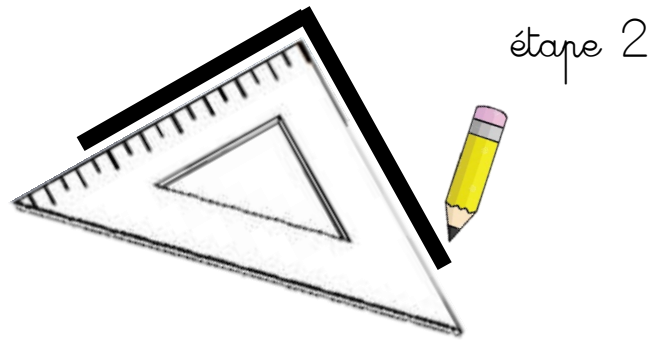
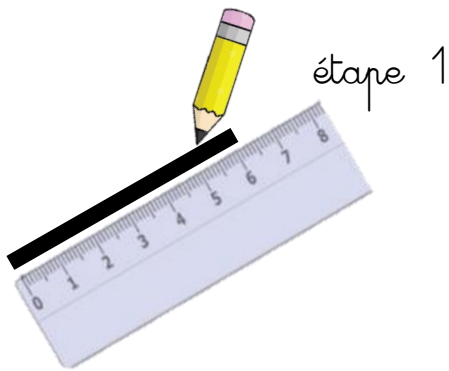

Trace un carré de 5 cm.

Trace un carré de 8 cm.

Trace un rectangle de 5 cm sur 8 cm.

Trace un rectangle de 4 cm sur 9 cm.