

Prénom : _____





Date : _____

Compte les syllabes orales de chaque mot

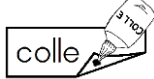

Colle les images dans la bonne colonne.



1 		2 	
3 		4 	

Prénom : _____

Date : _____



Colle autant de gommettes qu'il y a de syllabes orales dans le mot.

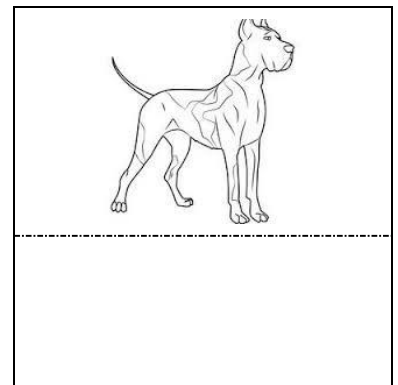
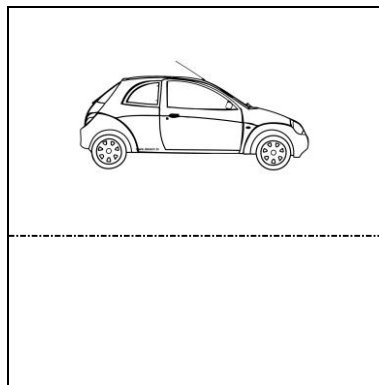
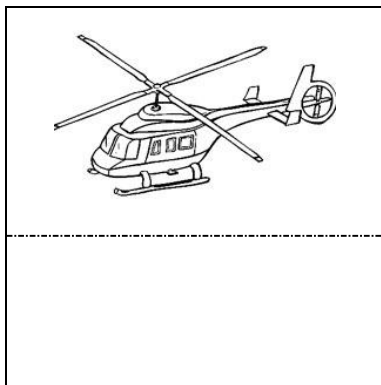
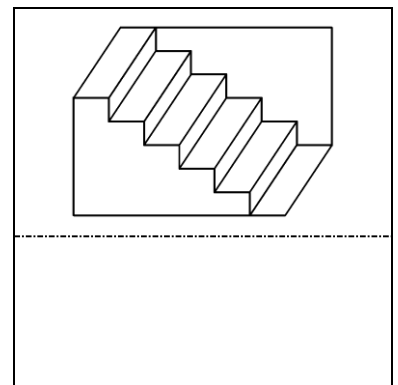
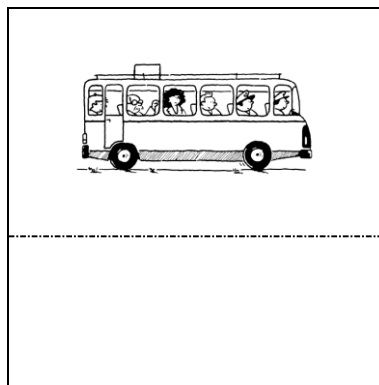
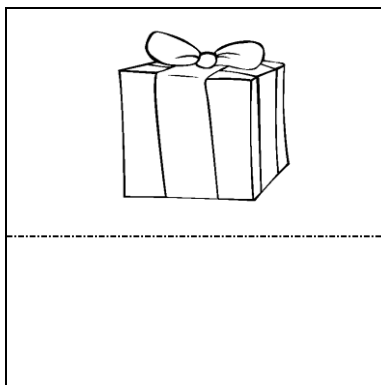
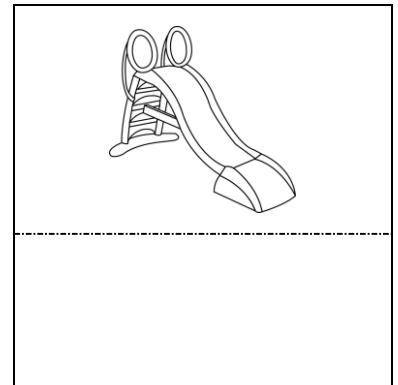
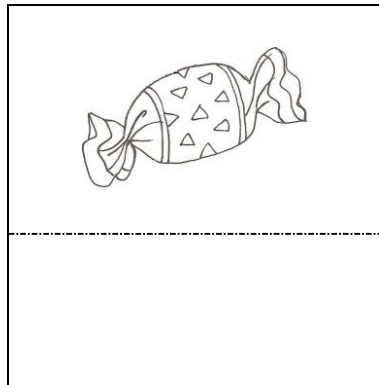
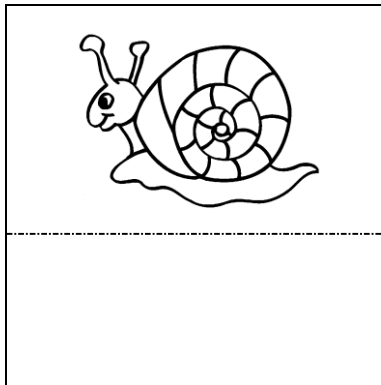

Prénom : _____

Date : _____



Colle autant de gommettes qu'il y a de syllabes orales dans le mot.

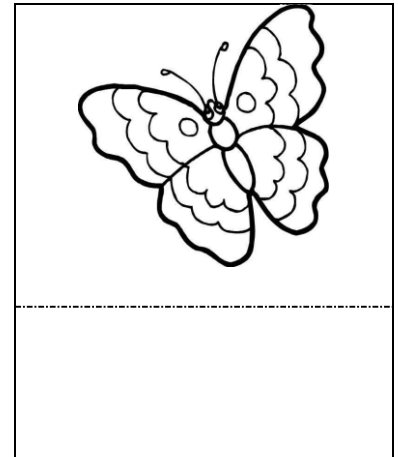
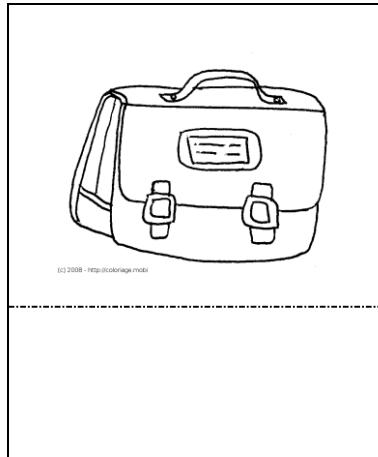
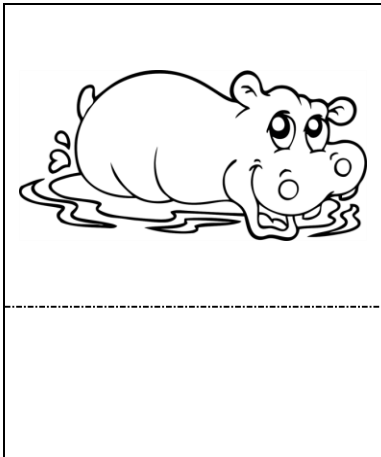
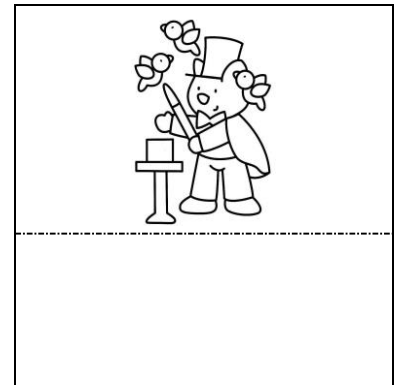
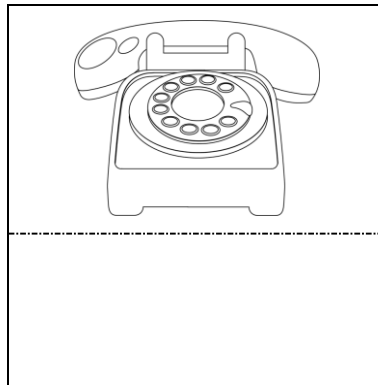
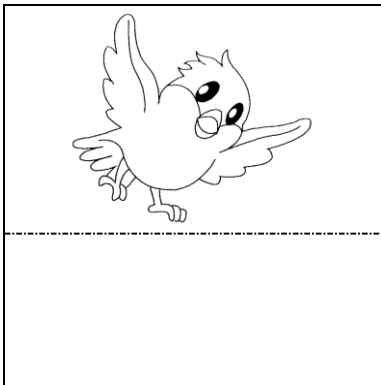
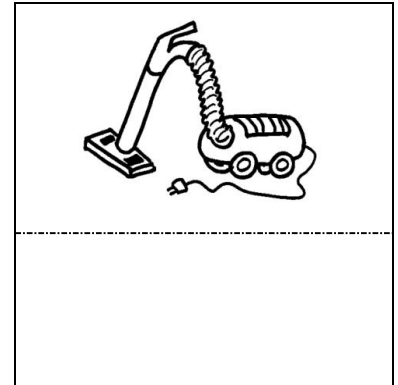
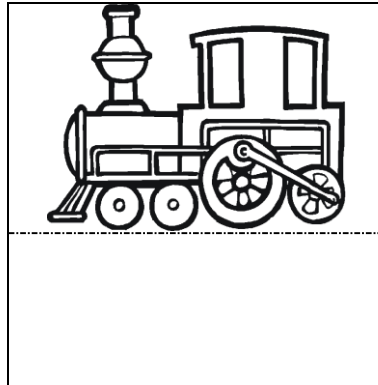
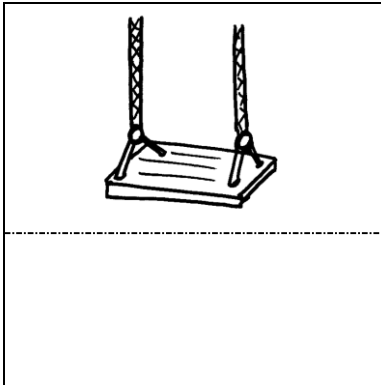



Prénom : _____

Date : _____



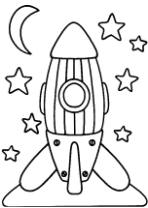

Dessine autant d'arc qu'il y a de syllabes orales dans le mot.











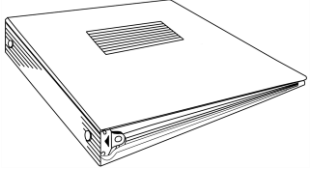





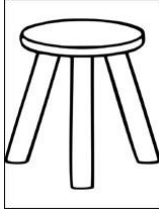

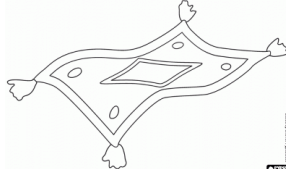





Prénom : _____

Date : _____



Dessine autant d'arc qu'il y a de syllabes orales dans le mot.





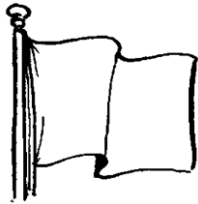

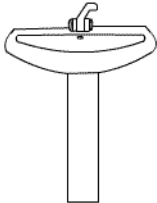

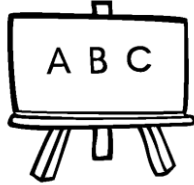









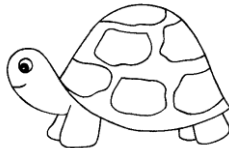



Prénom : _____

Date : _____

Colorie autant de cases qu'il y a de syllabes orales dans le mot.



--	--	--	--

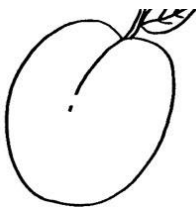

--	--	--	--



--	--	--	--

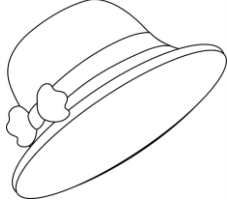

--	--	--	--



--	--	--	--

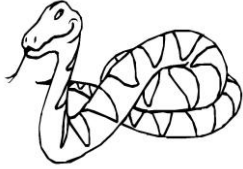

--	--	--	--

Prénom : _____

Date : _____

Colorie autant de cases qu'il y a de syllabes orales dans le mot.



--	--	--	--



--	--	--	--



--	--	--	--

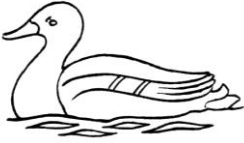

--	--	--	--

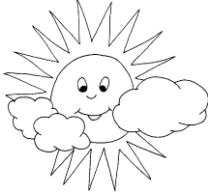

--	--	--	--



--	--	--	--

Prénom : _____

Date : _____

Dans chaque situation, colorie le dessin où il y a le plus de syllabes orales. 

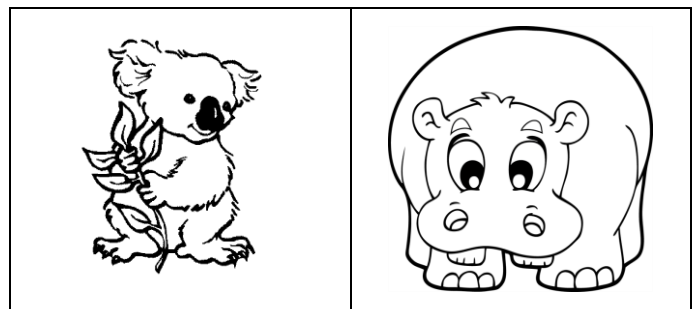
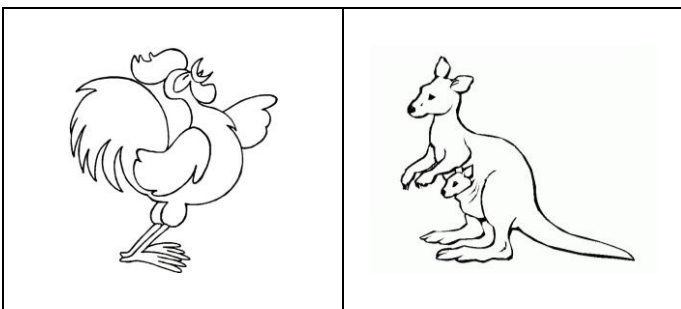
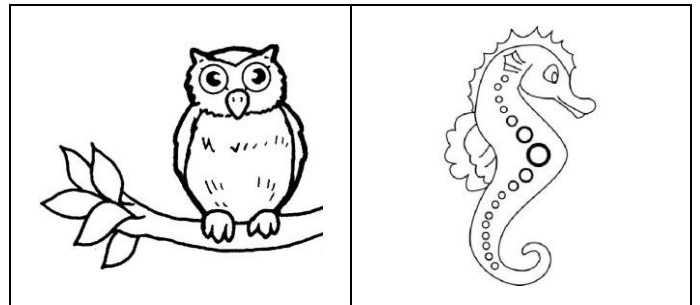
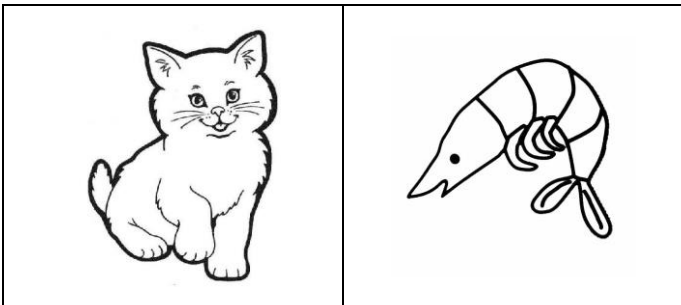
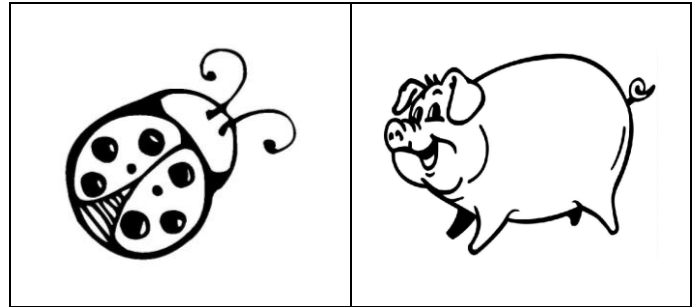
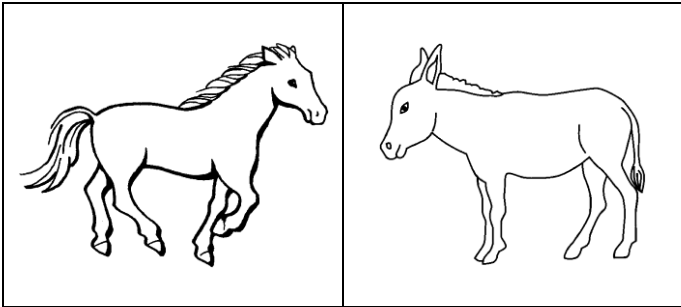

Prénom : _____

Date : _____

Dans chaque situation, colorie le dessin où il y a le plus de syllabes orales. 