



3. Merk ur groaz er silabennoù ma kleviz /y/ enne. (u)



un
dibuner



ur
balun



bugale



un
ur biataer



lunedou



ur
yuz bugen



ur
Arzutil

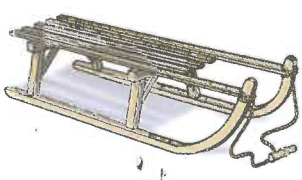

ur
ruzikell



un
alucbunell

4. Merk ur groaz er silabennoù ma kleviz /u/ enne. (ou)



ur
viskoulen



ul
lapous

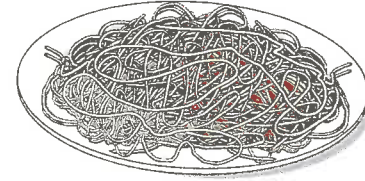

toazennou

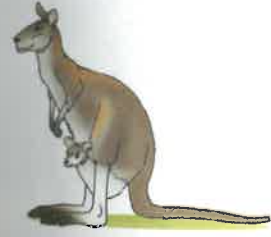

ur
c'hangoecrou



lunedou



la poussed



beur



ur
reudenneg



un
da beurlia