

NOM :

Prénom :

Classe :

Exercice
La projection orthogonale

CI 1 : Les techniques et outils de représentation du réel



Consignes :

Pour chaque système ci dessous,
Repérer par la lettre correspondante
les quatre vues manquantes du dessin
d'ensemble.

Compétence :

Associer une même
surface ou un même
volume dans plusieurs
vues d'une mise en plan.

Autonomie

Système étau

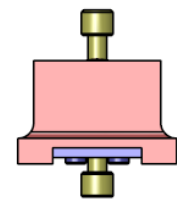
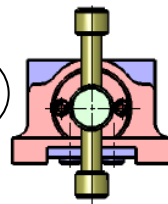
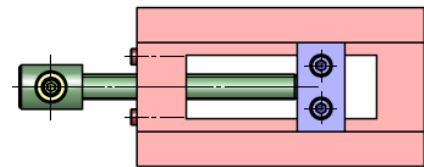
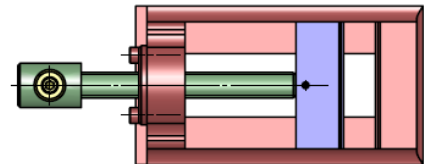
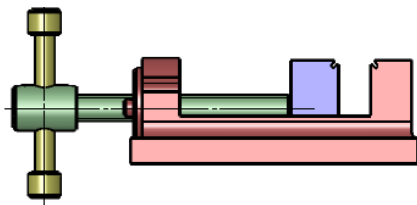
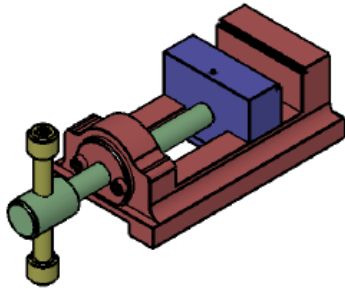

Système vanne

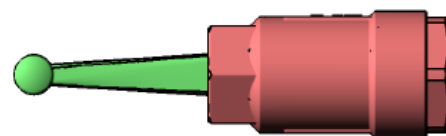
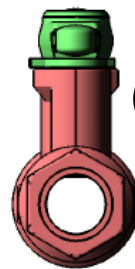
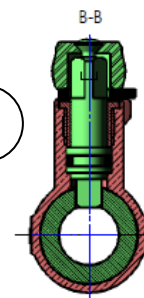
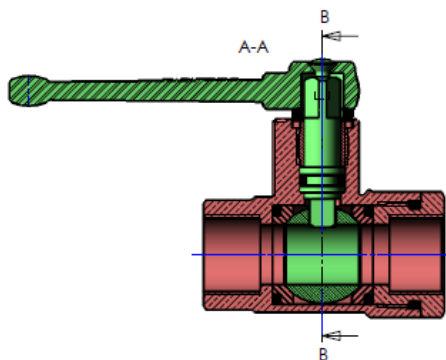
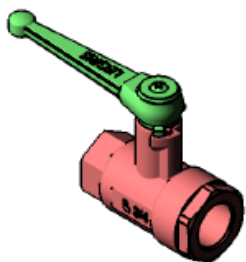

NOM :
Prénom :
Classe :

Exercice
La projection orthogonale

CI 1 : Les techniques et outils de représentation du réel



Système pompe hydraulique

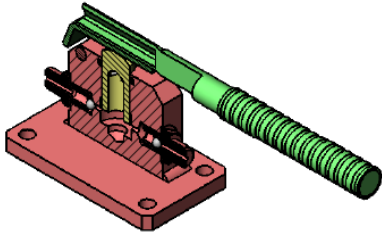

...

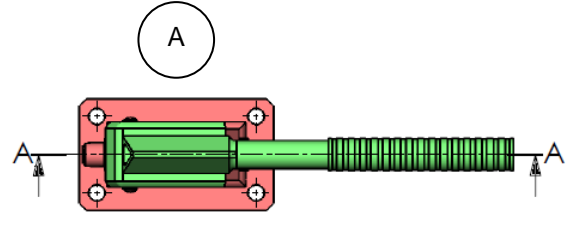

...

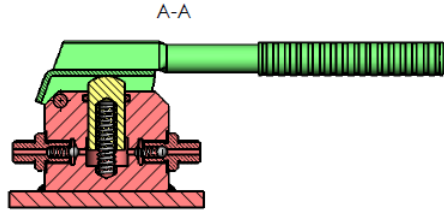

...

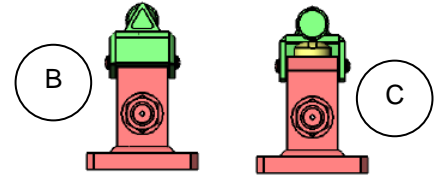

...

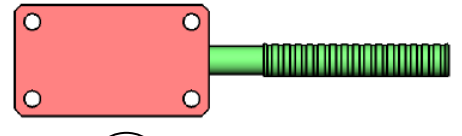

D

Système compresseur

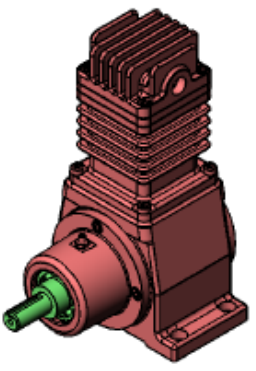

...

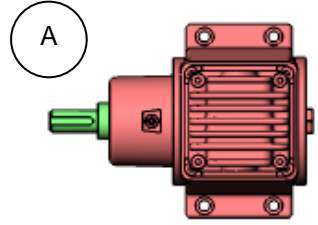

...

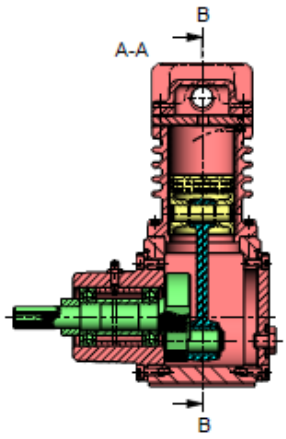

...

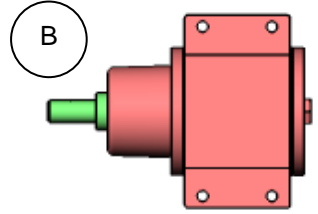

...

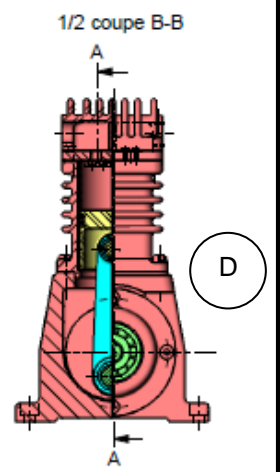
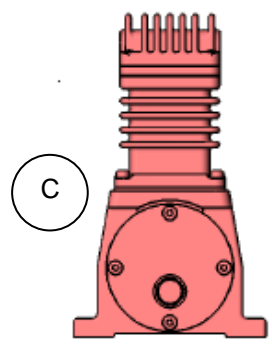

NOM :
Prénom :
Classe :

Exercice
La projection orthogonale

CI 1 : Les techniques et outils de représentation du réel



Systeme vérin double effet

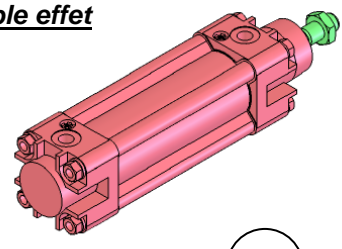

...

...

COUPE A-A

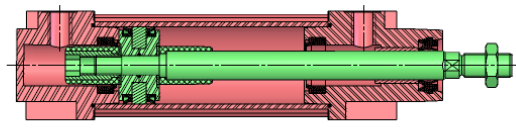

...

...

A

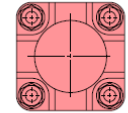
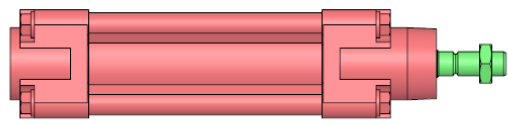

B

C

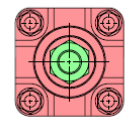
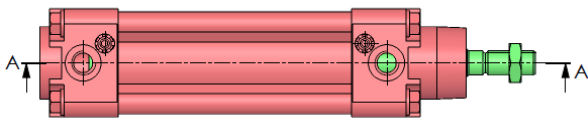

D

Systeme vérin rotatif

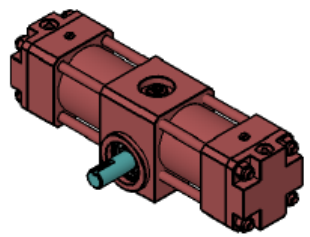

...

...

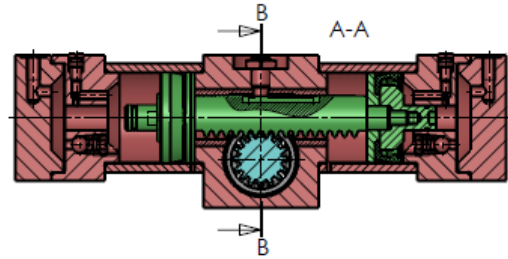

...

...

A

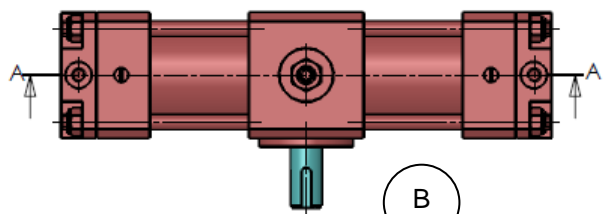
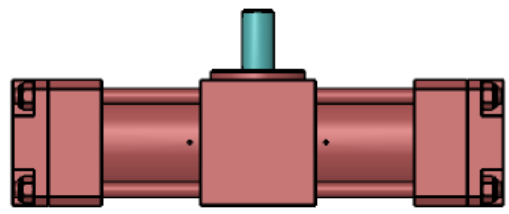

B

C

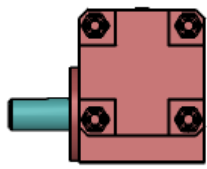
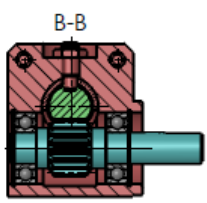

D

NOM :
Prénom :
Classe :

Exercice
La projection orthogonale

CI 1 : Les techniques et outils de représentation du réel



Systeme moteur

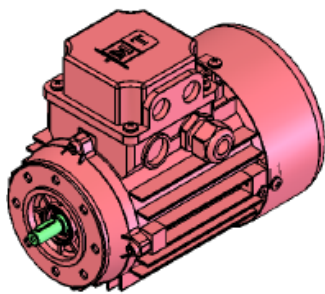

...

A-A

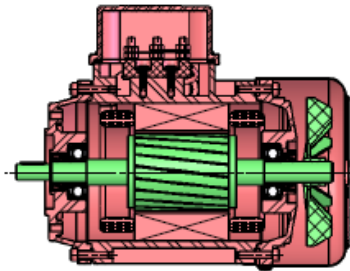

...

...

...

A

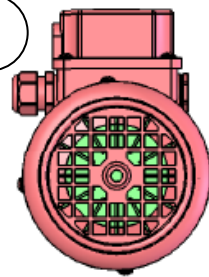

B

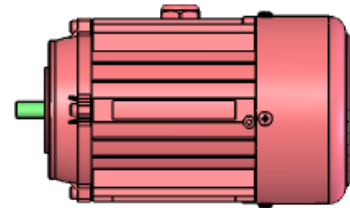
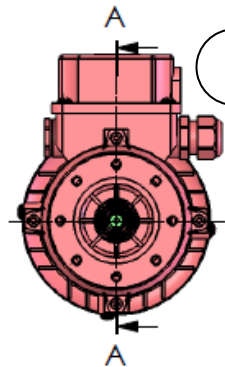

C

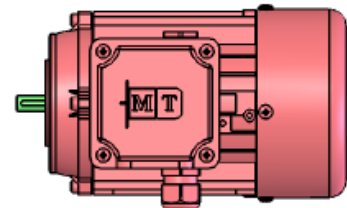

D

Systeme reducteur roue vis sans fin

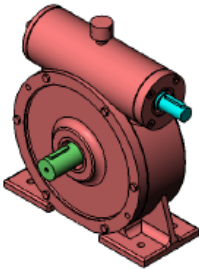

...

B
A-A

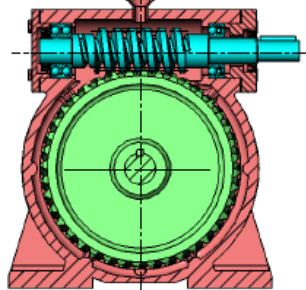

...

...

...

A

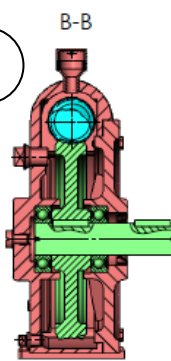

B

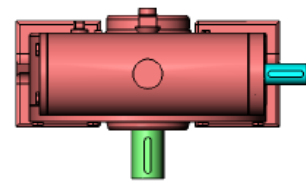
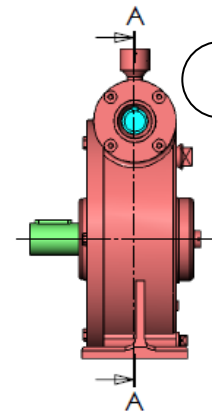

C

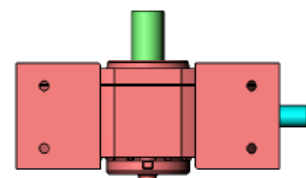

D