

La table de

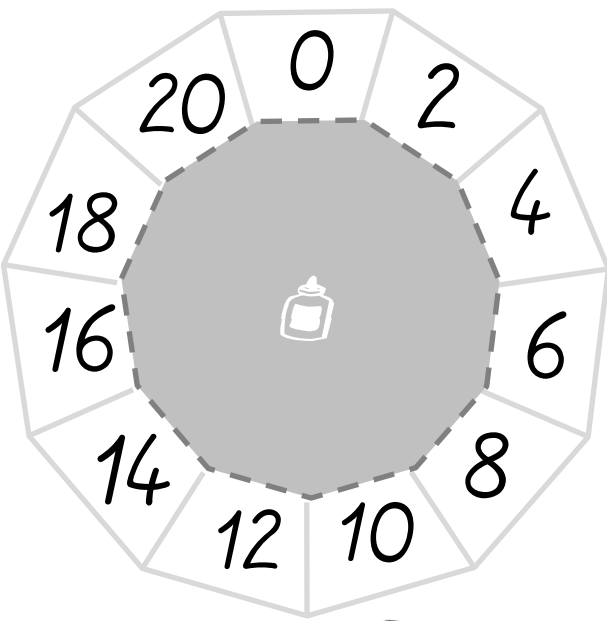

0	2	4	6	8
10	12	14	16	18
20				

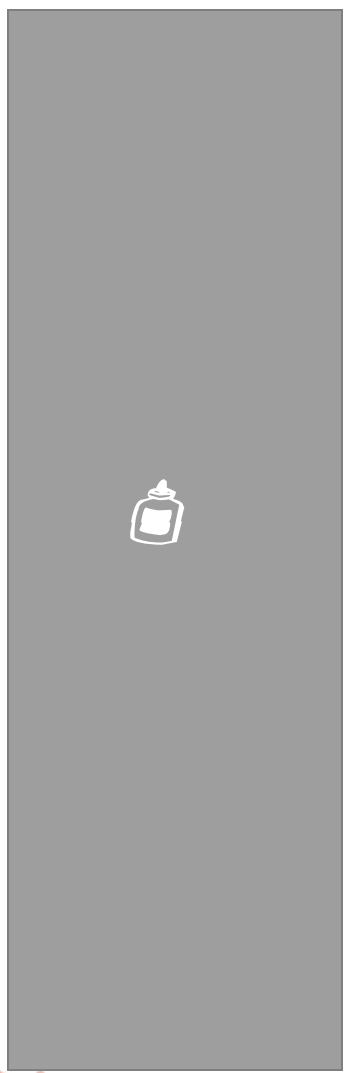







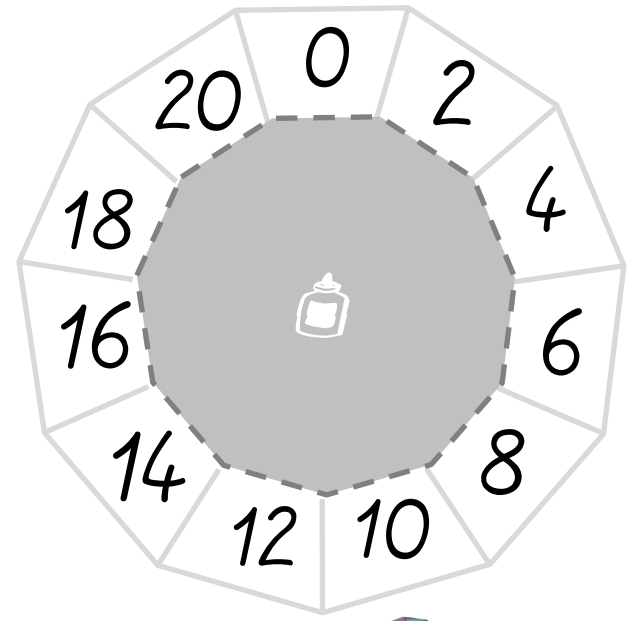
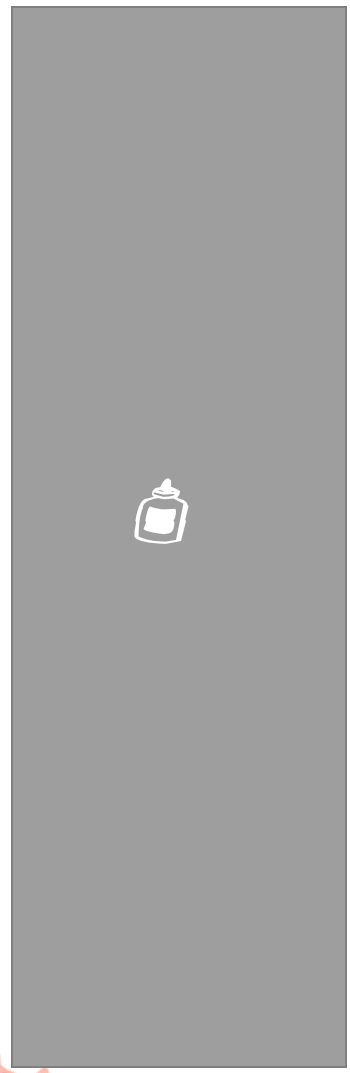

La table de



0	2	4	6	8
10	12	14	16	18
20				

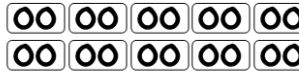

0×2	rien	0	= 0
1×2		2	= 2
2×2		$2 + 2$	= 4
3×2		$2 + 2 + 2$	= 6
4×2		$2 + 2 + 2 + 2$	= 8
5×2		$2 + 2 + 2 + 2 + 2$	= 10
6×2		$2 + 2 + 2 + 2 + 2 + 2$	= 12
7×2		$2 + 2 + 2 + 2 + 2 + 2 + 2$	= 14
8×2		$2 + 2 + 2 + 2 + 2 + 2 + 2 + 2$	= 16
9×2		$2 + 2 + 2 + 2 + 2 + 2 + 2 + 2 + 2$	= 18
10×2		$2 + 2 + 2 + 2 + 2 + 2 + 2 + 2 + 2 + 2$	= 20

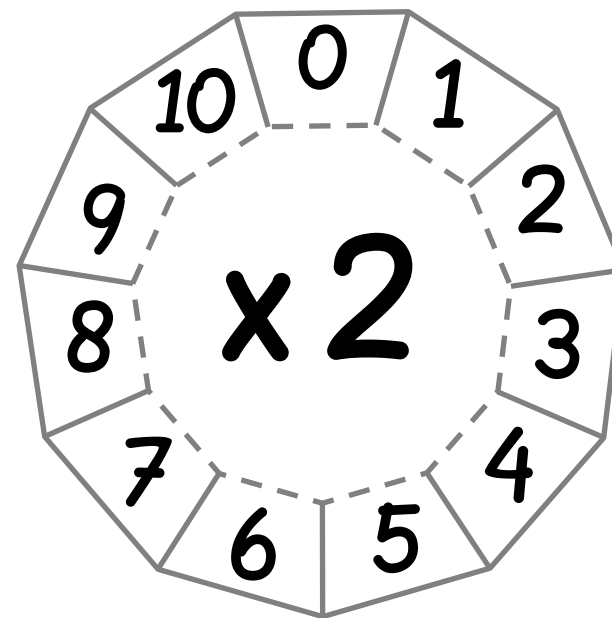

QR Code X2 en chanson

On choisit de le coller sur la leçon
ou non...

La table de

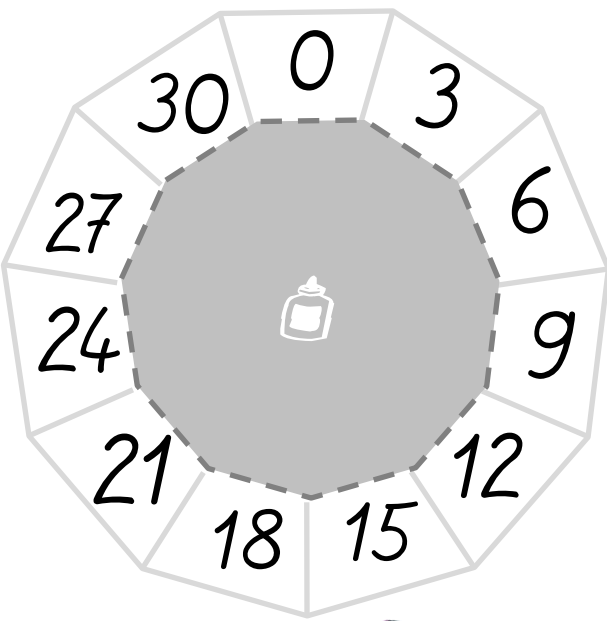
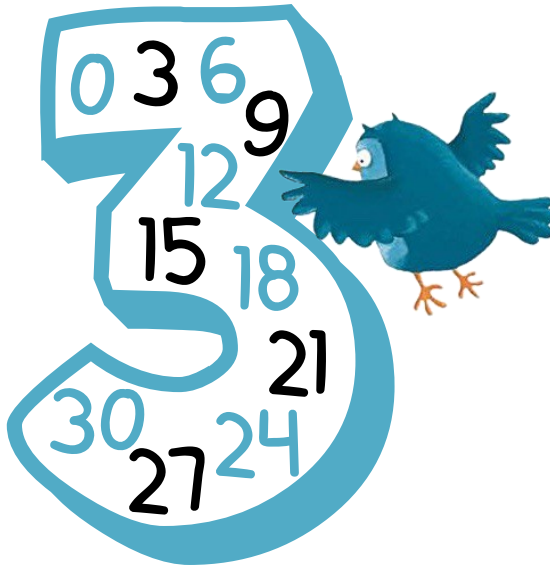

La table de

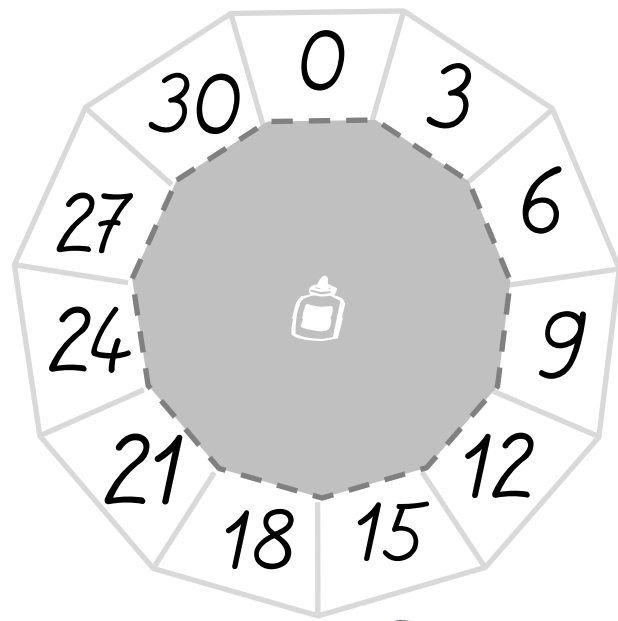
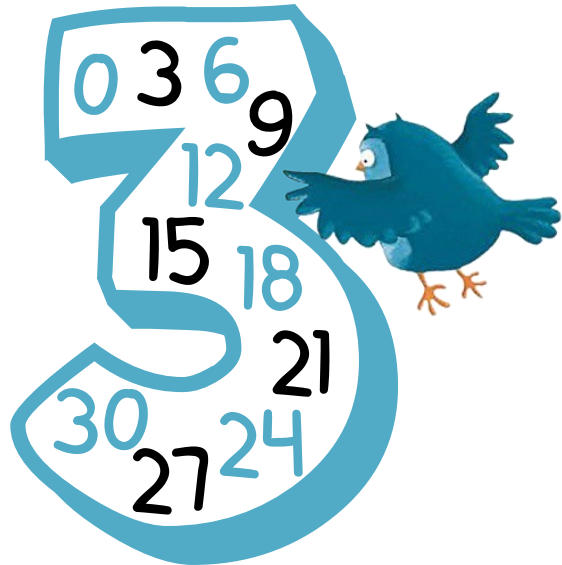
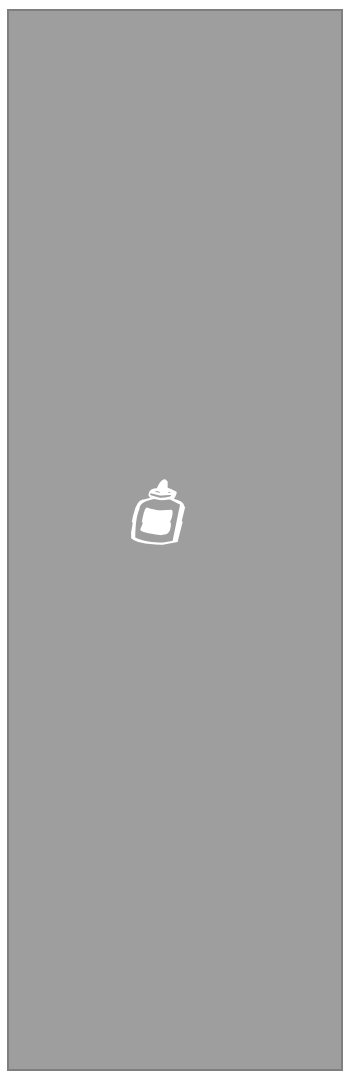

0×3	0	= 0
1×3	3	= 3
2×3	$3 + 3$	= 6
3×3	$3 + 3 + 3$	= 9
4×3	$3 + 3 + 3 + 3$	= 12
5×3	$3 + 3 + 3 + 3 + 3$	= 15
6×3	$3 + 3 + 3 + 3 + 3 + 3$	= 18
7×3	$3 + 3 + 3 + 3 + 3 + 3 + 3$	= 21
8×3	$3 + 3 + 3 + 3 + 3 + 3 + 3 + 3$	= 24
9×3	$3 + 3 + 3 + 3 + 3 + 3 + 3 + 3 + 3$	= 27
10×3	$3 + 3 + 3 + 3 + 3 + 3 + 3 + 3 + 3 + 3$	= 30

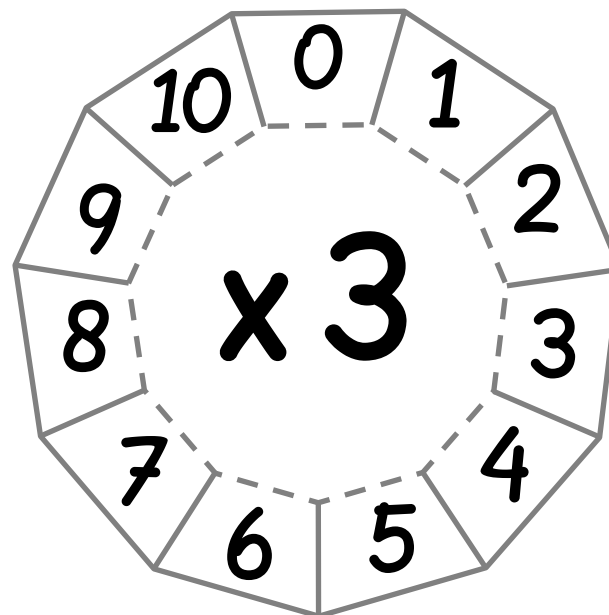

La table de



0	16	
4	20	
8	24	28
12	32	
16	36	
20	40	

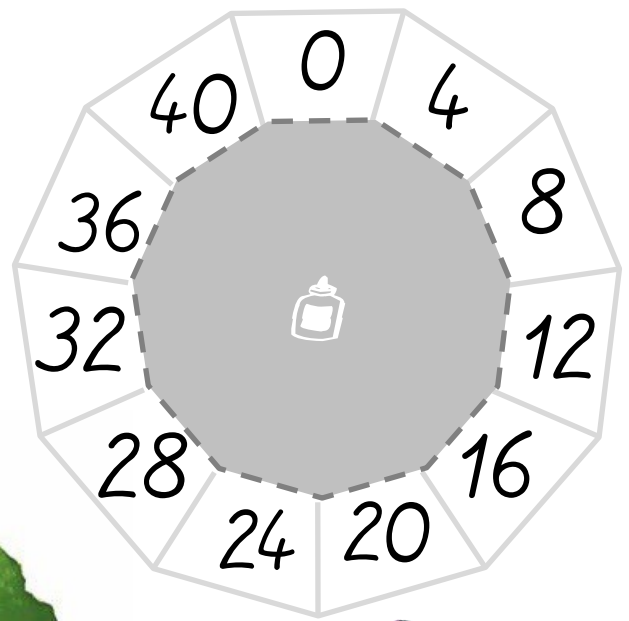

La table de



0	16	
4	20	
8	24	28
12	32	
16	36	
20	40	

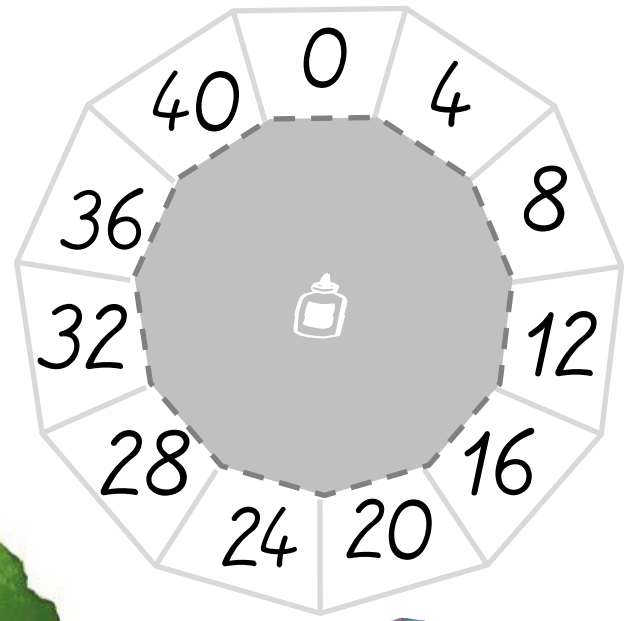

0×4	0	= 0
1×4	4	= 4
2×4	4 + 4	= 8
3×4	4 + 4 + 4	= 12
4×4	4 + 4 + 4 + 4	= 16
5×4	4 + 4 + 4 + 4 + 4	= 20
6×4	4 + 4 + 4 + 4 + 4 + 4	= 24
7×4	4 + 4 + 4 + 4 + 4 + 4 + 4	= 28
8×4	4 + 4 + 4 + 4 + 4 + 4 + 4 + 4	= 32
9×4	4 + 4 + 4 + 4 + 4 + 4 + 4 + 4 + 4	= 36
10×4	4 + 4 + 4 + 4 + 4 + 4 + 4 + 4 + 4 + 4	= 40

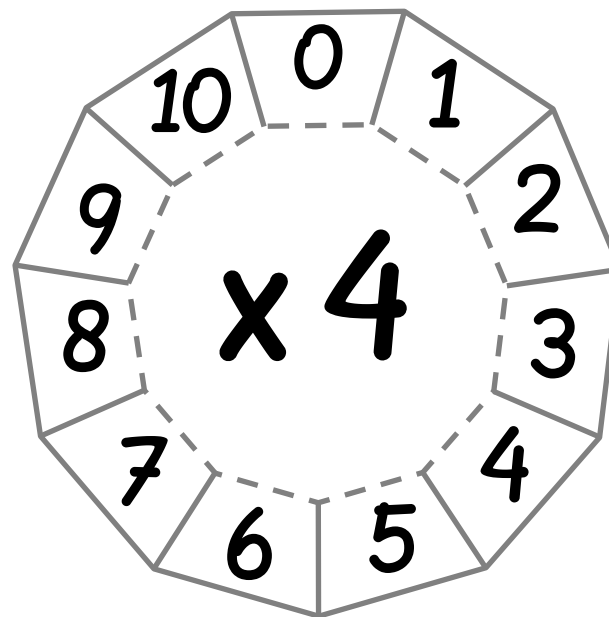

5

multiplications

La table de

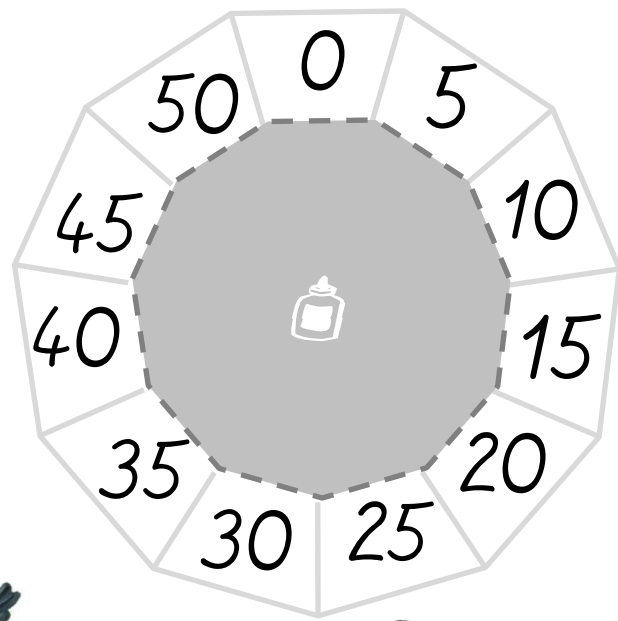
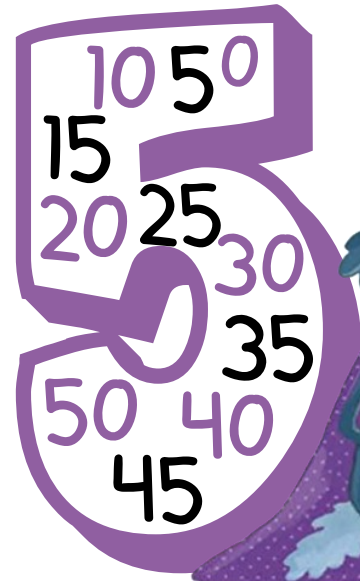

5

multiplications

La table de

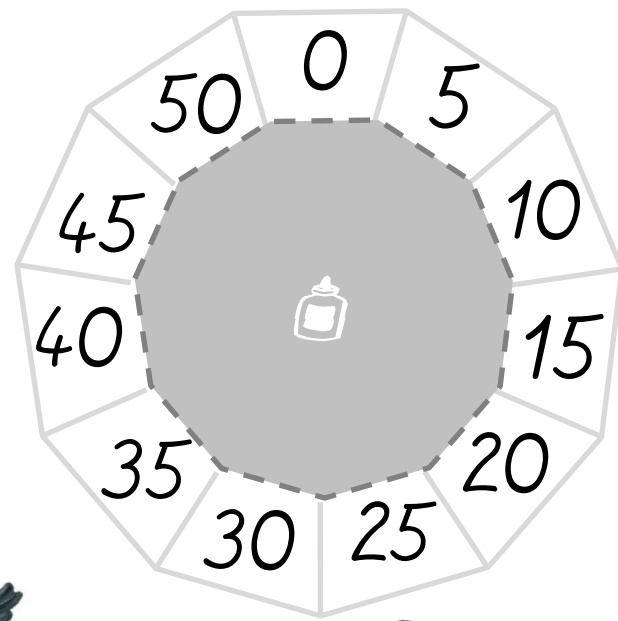
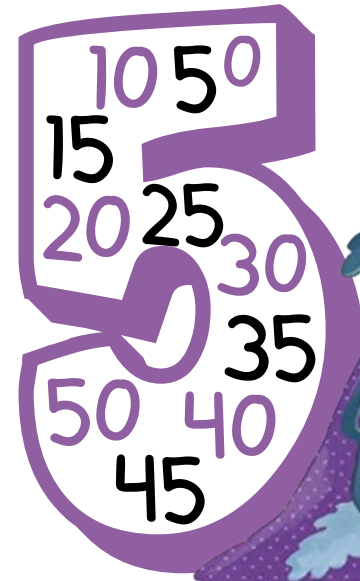

0×5	0	= 0
1×5	5	= 5
2×5	5 + 5	= 10
3×5	5 + 5 + 5	= 15
4×5	5 + 5 + 5 + 5	= 20
5×5	5 + 5 + 5 + 5 + 5	= 25
6×5	5 + 5 + 5 + 5 + 5 + 5	= 30
7×5	5 + 5 + 5 + 5 + 5 + 5 + 5	= 35
8×5	5 + 5 + 5 + 5 + 5 + 5 + 5 + 5	= 40
9×5	5 + 5 + 5 + 5 + 5 + 5 + 5 + 5 + 5	= 45
10×5	5 + 5 + 5 + 5 + 5 + 5 + 5 + 5 + 5 + 5	= 50

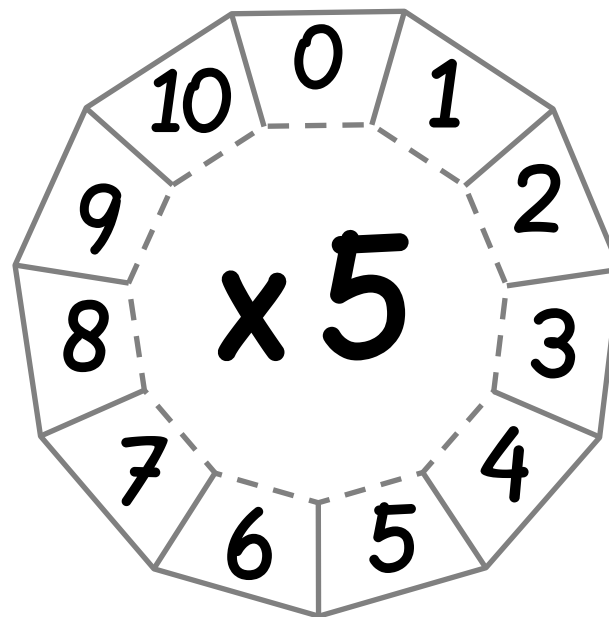

La table de

= 0
= 6
= 12
= 18
= 24
= 30
= 36
= 42
= 48
= 54
= 60

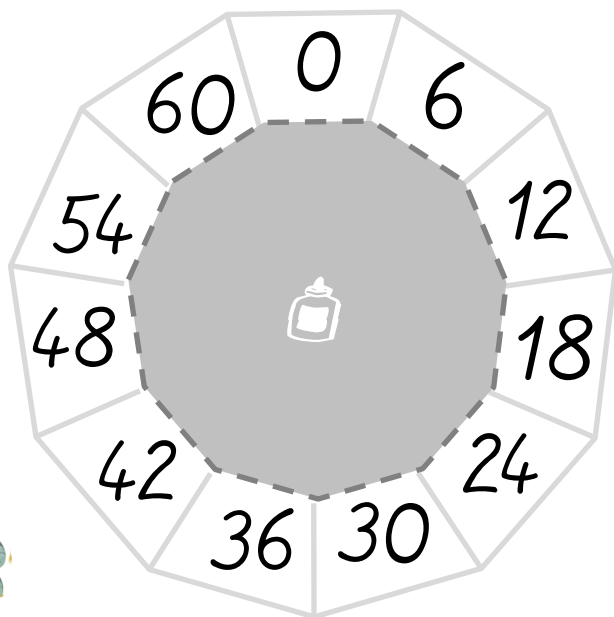

0×6
1×6
2×6
3×6
4×6
5×6
6×6
7×6
8×6
9×6
10×6

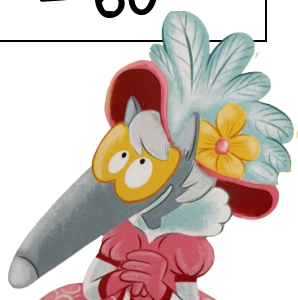
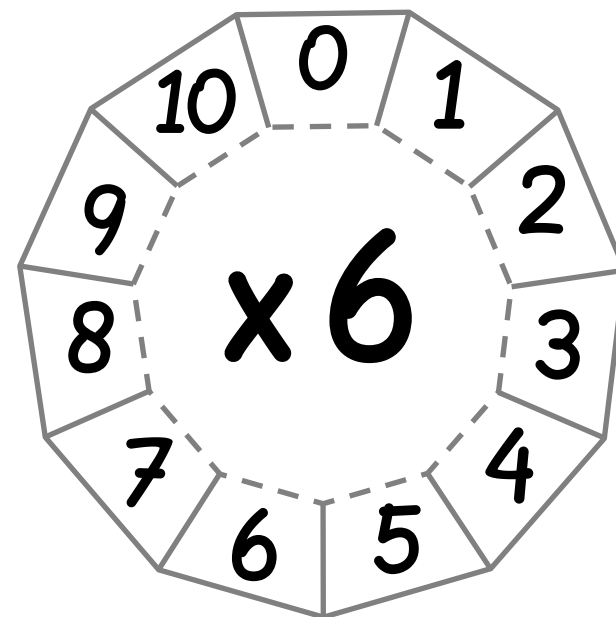

La table de

= 0
= 7
= 14
= 21
= 28
= 35
= 42
= 49
= 56
= 63
= 70

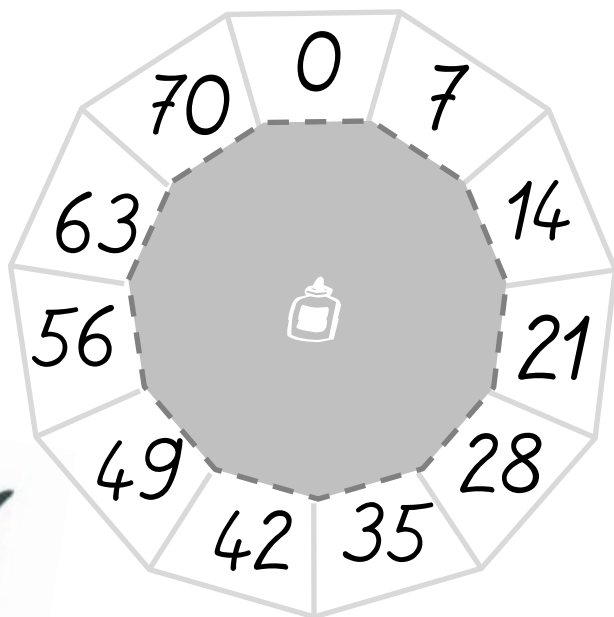
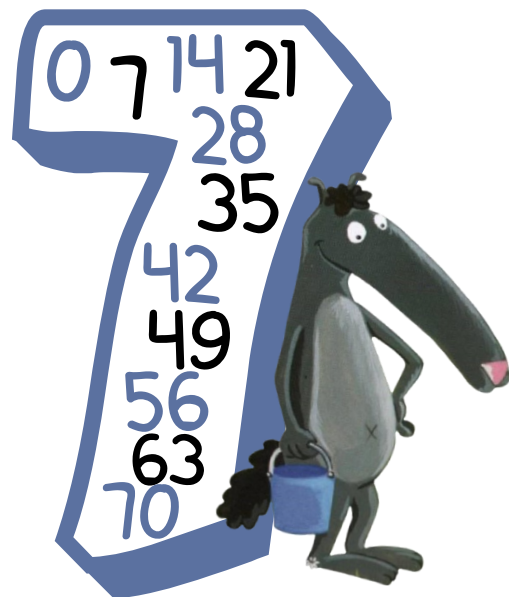

0×7
1×7
2×7
3×7
4×7
5×7
6×7
7×7
8×7
9×7
10×7

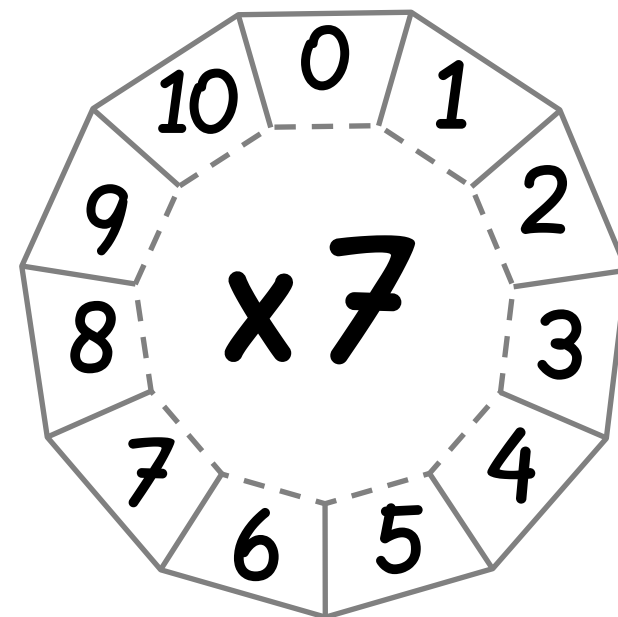

La table de

= 0
= 8
= 16
= 24
= 32
= 40
= 48
= 56
= 64
= 72
= 80

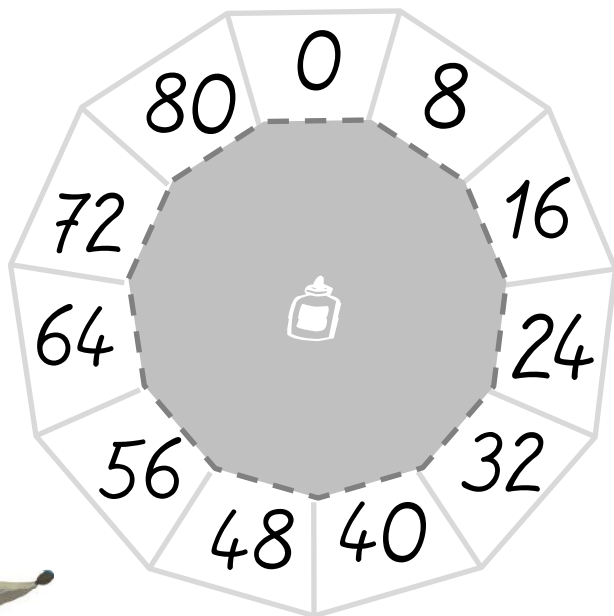
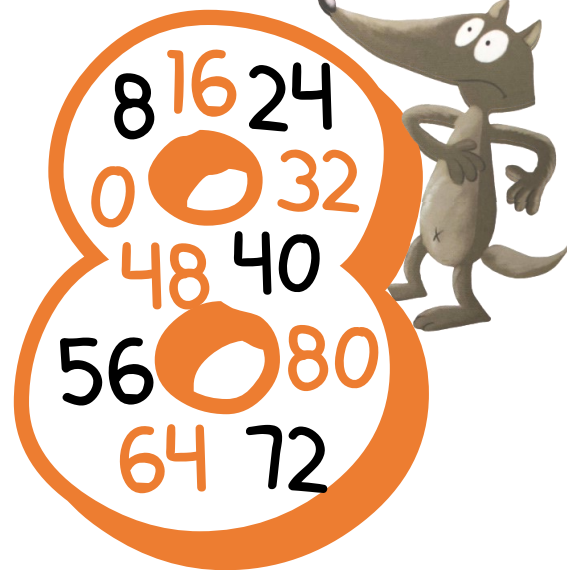

0 x 8
1 x 8
2 x 8
3 x 8
4 x 8
5 x 8
6 x 8
7 x 8
8 x 8
9 x 8
10 x 8

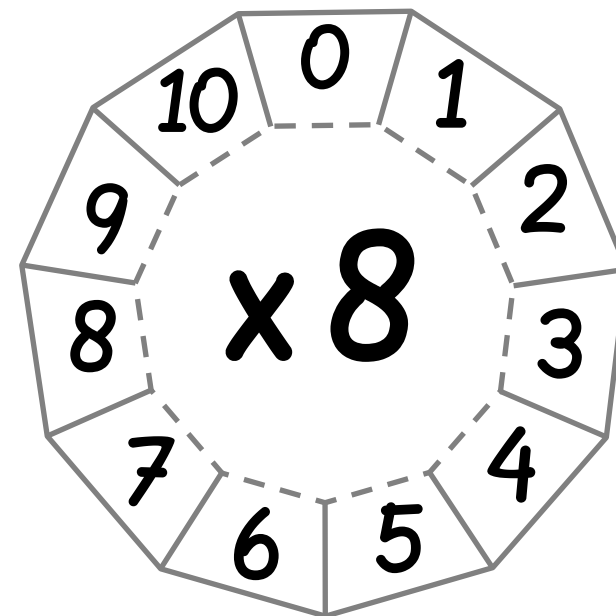

La table de

= 0
= 9
= 18
= 27
= 36
= 45
= 54
= 63
= 72
= 81
= 90

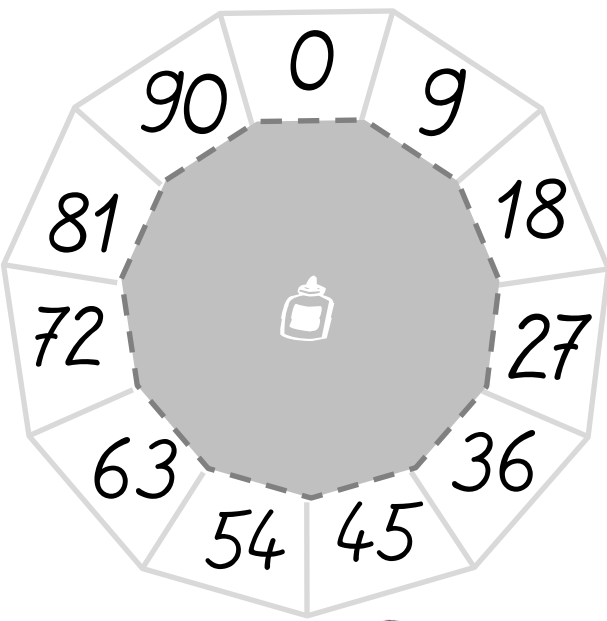
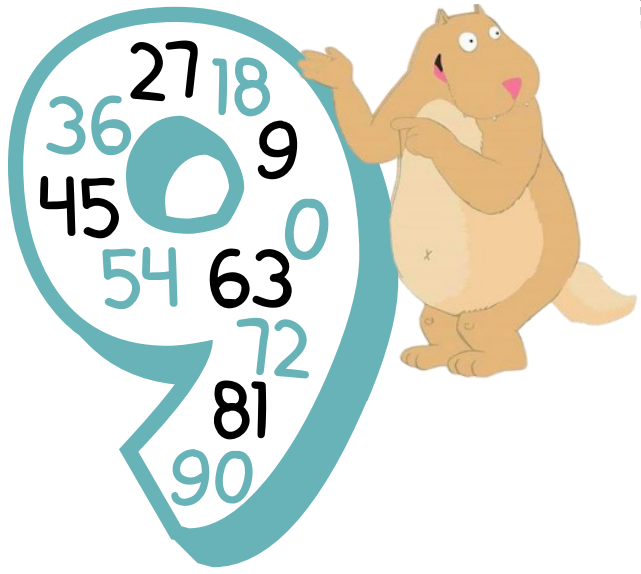

0 x 9
1 x 9
2 x 9
3 x 9
4 x 9
5 x 9
6 x 9
7 x 9
8 x 9
9 x 9
10 x 9

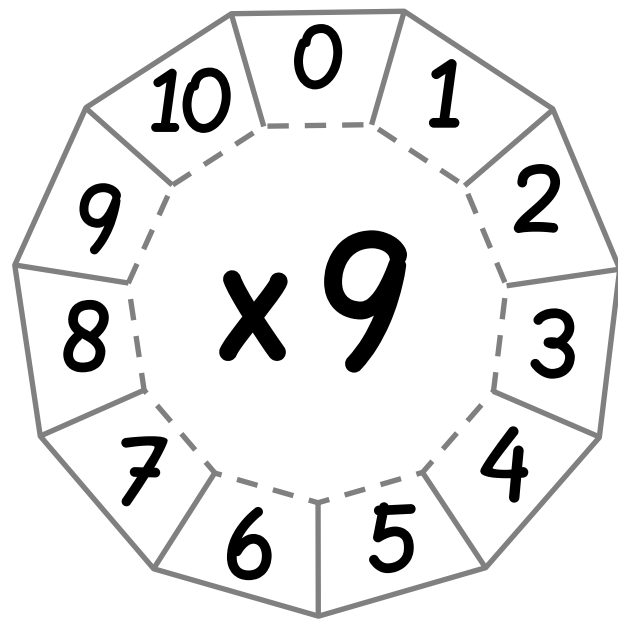

La table de

= 0
= 10
= 20
= 30
= 40
= 50
= 60
= 70
= 80
= 90
= 100

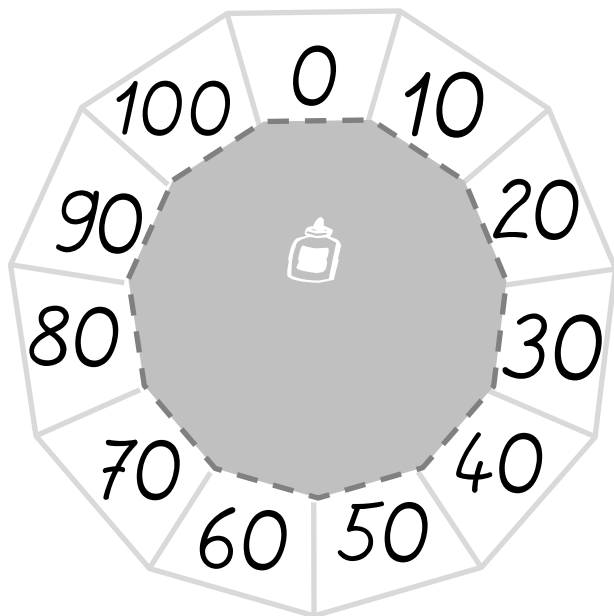
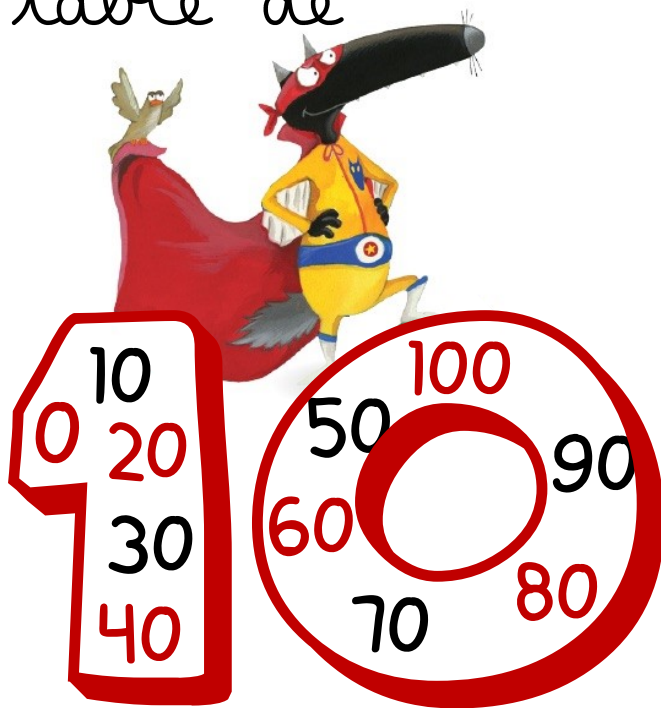

0 x 10
1 x 10
2 x 10
3 x 10
4 x 10
5 x 10
6 x 10
7 x 10
8 x 10
9 x 10
10 x 10

